



GTM-203-3GWA

AT Commands Manual



Contents

1.	ATcommand settings	15
1.1	Definitions	15
1.2	Profiles	17
1.3	S-parameters.....	18
2.	General operation.....	19
2.1	Start up and initialization.....	19
2.2	AT commands types.....	19
3.	IPC - Inter Processor Communication	21
3.1	Multiplexing mode +CMUX	21
4.	General.....	23
4.1	Manufacturer identification +CGMI.....	23
4.2	Model identification +CGMM.....	23
4.3	Firmware version identification +CGMR.....	24
4.4	IMEI identification +CGSN.....	24
4.5	Manufacturer identification +GMI.....	24
4.6	Model identification +GMM.....	25
4.7	Firmware version identification +GMR.....	25
4.8	IMEI identification +GSN	26
4.9	Identification information I	26
4.10	TE character set configuration +CSCS.....	27
4.11	International mobile subscriber identification +CIMI	27
4.12	Card identification +CCID.....	28
4.13	Request complete capabilities list +GCAP.....	28
4.14	Repeat last command A/.....	29
4.15	List all available AT commands +CLAC.....	29
4.16	Help displaying all commands &H.....	30
5.	Mobile equipment control and status.....	31
5.1	Phone activity status +CPAS	31
5.2	Module switch off +CPWROFF	31
5.3	Set phone functionality +CFUN.....	32
5.4	Indicator control +CIND	33
5.5	Configuration of indicator control +UCIND.....	35
5.6	Mobile termination event reporting +CMER.....	35



5.7	Clock +CCLK.....	37
5.8	Alarm +CALA.....	38
5.9	Delete alarm +CALD.....	39
5.10	Alert sound mode +CALM.....	40
5.11	Ringer sound level +CRSL.....	40
5.12	Loudspeaker volume level +CLVL.....	41
5.13	Mute control +CMUT.....	42
5.14	Call meter maximum event +CCWE.....	42
5.15	Set greeting text +CSGT.....	43
5.16	Automatic time zone update +CTZU.....	44
5.17	Time zone reporting +CTZR.....	44
5.18	Report mobile termination error +CMEE.....	45
6.	Call control.....	46
6.1	Select type of address +CSTA.....	46
6.2	Dial command D.....	46
6.3	Direct calling from phonebooks D>.....	48
6.4	Select tone dialling T.....	49
6.5	Select pulse dialling P.....	49
6.6	Call answer A.....	50
6.7	Hook control H.....	50
6.8	Monitor speaker loudness L.....	50
6.9	Monitor speaker mode M.....	51
6.10	Call mode +CMOD.....	51
6.11	Hang up call +CHUP.....	52
6.12	Single numbering scheme +CSNS.....	52
6.13	Set reporting call status +UCALLSTAT.....	53
6.14	Information to in-band-tones availability +UPROGRESS.....	54
6.15	Tone duration +VTD.....	55
6.16	DTMF and tone generation +VTS.....	55
6.17	Start and stop tone generation +UVTS.....	56
6.18	Redial last telephone number DL.....	57
6.19	Automatic answer S0.....	57
6.20	Set voice mail number +CSVM.....	58
7.	Network service.....	59
7.1	Subscriber number +CNUM.....	59



- 7.2 Signal quality +CSQ59
- 7.3 Operator selection +COPS.....60
- 7.4 Radio Access technology selection +URAT63
- 7.5 Display EONS names +UEONS.....64
- 7.6 Display operator name +UDOPN.....65
- 7.7 Preferred PLMN list selection +CPLS66
- 7.8 PS Operator selection +UCGOPS.....67
- 7.9 Network registration +CREG68
- 7.10 HSDPA/HSUPA mode configuration+UHSDUPA.....70
- 7.11 Preferred operator list +CPOL.....71
- 7.12 Read operator names +COPN73
- 7.13 Steering of Roaming configuration +UDCONF=2073
- 7.14 Fast Dormancy activation +UFDAC.....74
- 7.15 Fast Dormancy configuration +UDCONF=61.....75
- 7.16 Network selection control +PACSP.....75
- 7.17 Integrity check on test networks configuration +UDCONF=8176
- 7.18 Select band +UBANDSEL.....77
- 7.19 Cell environment description +CGED.....78
- 7.20 Provide cell information +UCELLINFO88
- 7.21 Lock on a specific cell +UCELLLOCK89
- 7.22 Wireless service selection +WS4692
- 7.23 Home zone reporting+UHOMEZR.....92
- 7.24 Jamming Detection +UCD93
- 8. Security96
 - 8.1 Enter PIN +CPIN96
 - 8.2 Read remaining SIMPIN attempts +UPINCNT97
 - 8.3 Facility lock +CLCK97
 - 8.4 Change password +CPWD99
 - 8.5 Custom SIMlock +USIMLCK99
- 9. Phonebook.....102
 - 9.1 Select phonebook memory storage +CPBS102
 - 9.2 Read phonebook entries +CPBR.....102
 - 9.3 Find phonebook entries +CPBF.....104
 - 9.4 Write phonebook entry +CPBW105
- 10. Short Messages Service107



10.1	Introduction	107
10.2	Select message service +CSMS	107
10.3	Preferred message storage +CPMS	108
10.4	Preferred message format +CMGF	109
10.5	Save settings +CSAS	110
10.6	Restore settings +CRES	110
10.7	Show text mode parameters +CSDH	111
10.8	New message indication +CNMI	111
10.9	Read message +CMGR	114
10.10	New message acknowledgement to MT +CNMA	117
10.11	List message +CMGL	118
10.12	Send message +CMGS	120
10.13	Write message to memory +CMGW	121
10.14	Send message from storage +CMSS	122
10.15	Set text mode parameters +CSMP	122
10.16	Delete message +CMGD	123
10.17	Service center address +CSCA	124
10.18	Select cell broadcast message types +CSCB	125
10.19	Read concatenated message +UCMGR	125
10.20	List concatenated message +UCMGL	128
10.21	Send concatenated message +UCMGS	130
10.22	Write concatenated message to memory +UCMGW	131
10.23	More Messages to Send +CMMS	133
10.24	Peek message +UCMGP	133
10.25	Message Waiting Indication +UMWI	134
11.	Supplementary services	136
11.1	Call forwarding +CCFC	136
11.2	Call waiting +CCWA	137
11.3	Calling line identification restriction +CLIR	139
11.4	Calling line identification presentation +CLIP	139
11.5	Connected line identification presentation +COLP	140
11.6	Connected line identification restriction +COLR	141
11.7	Advice of charge +CAOC	142
11.8	Accumulated call meter +CACM	142
11.9	Accumulated call meter maximum +CAMP	143
11.10	Price per unit and currency table +CPUC	144



11.11	Call related supplementary services +CHLD.....	144
11.12	Call deflection +CTFR.....	145
11.13	List current calls +CLCC	145
11.14	Supplementary service notifications +CSSN.....	146
11.15	User to user signalling service 1 +CUUS1.....	148
11.16	Unstructured supplementary service data +CUSD.....	149
11.17	Closed user group +CCUG.....	150
11.18	Calling name presentation +CNAP	151
12.	Circuit switched data services	152
12.1	Introduction	152
12.2	Select bearer service type +CBST	152
12.3	Connection type groups configuration +UDCONF=32.....	154
12.4	Circuit switched data configuration+UCSD	155
12.5	Circuit switched data action +UCSDA.....	156
12.6	Circuit switched network-assigned data +UCSND	157
12.7	Service class selection and identification +FCLASS	158
12.8	Service reporting control +CR.....	158
12.9	Cellular result codes +CRC	159
12.10	Radio link protocol +CRLP	160
12.11	Extended error report +CEER	161
12.12	Proprietary extended error report +UCEER.....	162
13.	FAX class 2.....	163
13.1	Introduction	163
13.2	Adaptive answer +FAA	163
13.3	Address & polling capabilities +FAP.....	163
13.4	Buffer size +FBS.....	164
13.5	Data bit order +FBO	164
13.6	HDLC frame reporting +FBU	165
13.7	DS capabilities parameters +FCC	165
13.8	Copy quality checking +FCQ.....	166
13.9	Capability to receive data +FCR.....	166
13.10	Current session results +FCS.....	167
13.11	DTE phase C response timeout +FCT	167
13.12	Receive data +FDR	168
13.13	Transmit Data +FDT.....	168



13.14	Phase Creceived EOL alignment +FEA	168
13.15	Format conversion +FFC	169
13.16	Report file transfer diagnostic frame +FFD	170
13.17	Call termination status +FHS	170
13.18	Procedure interrupt enable +FIE.....	170
13.19	Initialize facsimile parameters +FIP.....	171
13.20	Current session parameters +FIS	172
13.21	Inactivity timeout +FIT.....	172
13.22	Session termination +FKS, +FK	173
13.23	Local ID string +FLI	173
13.24	Set flow control +FLO	174
13.25	Indicate document to poll +FLP	174
13.26	Request manufacturer identification +FMI	175
13.27	Request model identification +FMM.....	175
13.28	Request revision identification +FMR.....	175
13.29	Minimum phase C speed +FMS.....	176
13.30	Negotiation reporting +FNR.....	176
13.31	Non-standard frame FIF octet string +FNS.....	177
13.32	NSFmessage data indication +FND	177
13.33	Selective polling address +FPA	178
13.34	Local polling ID string +FPI	178
13.35	Packet protocol control +FPP	179
13.36	Page status +FPS	179
13.37	Password parameter +FPW.....	180
13.38	Receive quality thresholds +FRQ.....	180
13.39	Error correction mode retry count +FRY	181
13.40	SubAddress parameter +FSA.....	181
13.41	Request to poll +FSP.....	182
13.42	Fax intermediate result codes.....	182
14.	V24 control and V25ter.....	183
14.1	Introduction	183
14.2	Circuit 109 behavior &C.....	183
14.3	Circuit 108/2 behavior &D.....	183
14.4	DSRoverride &S	185
14.5	Flow control &K.....	185
14.6	DTE-DCE character framing +ICF.....	187



14.7	DTE-DCE local flow control +IFC	189
14.8	Set flow control \Q.....	190
14.9	Fixed DTE rate +IPR.....	191
14.10	System can Return to on-line data state O.....	193
14.11	Escape character S2.....	194
14.12	Command line termination character S3.....	195
14.13	Response formatting character S4.....	196
14.14	Command line editing character S5.....	196
14.15	Pause before blind dialling S6.....	197
14.16	Connection completion timeout S7	197
14.17	Command dial modifier time S8.....	198
14.18	Automatic disconnect delay S10	198
14.19	Escape prompt delay (EPD) S12	199
14.20	Command echo E.....	200
14.21	Result code suppression Q.....	200
14.22	DCE response format V	201
14.23	Result code selection and call progress monitoring control X.....	201
14.24	Reset to default configuration Z.....	202
14.25	Set to factory defined configuration &F.....	202
14.26	Store current configuration &W	203
14.27	Display current configuration &V.....	203
14.28	Designate a default reset profile &Y.....	204
14.29	Parity bit transmission over the air +UTPB.....	204
15.	SIMmanagement.....	207
15.1	Restricted SIM access +CRSM.....	207
15.2	Generic SIMaccess +CSIM.....	208
15.3	Read the SIMlanguage +CLAN.....	208
15.4	Check for UICC card +UUICC	209
15.5	Customer service profile +UCSP	209
15.6	SIMhot insertion detection configuration +UDCONF=50.....	210
16.	SIMtoolkit	211
16.1	Introduction	211
16.2	Proactive command +STKPRO	211
16.3	Terminal response +STKTR	214
16.4	Envelope +STKENV.....	216



16.5	Terminal profile +STKPROF.....	217
16.6	Call and short message control URC +STKCC	218
16.7	Proactive session status URC +STKCNF	219
16.8	Envelope download in raw mode +SATE.....	219
16.9	Proactive command indication in raw mode +SATI	220
16.10	Proactive command indication in raw mode +SATN	220
16.11	Send terminal response in raw mode +SATR.....	221
16.12	Terminal response confirmation +SATF.....	221
16.13	User confirmation for SET UP call in raw mode +SATD	222
16.14	Indication for Mo Call Control / Mo SMS Control +STKCTRLIND	222
17.	Packet switched data services	224
17.1	Common parameters definition.....	224
17.2	PPP LCP handshake behaviour	230
17.3	Define PDP context +CGDCONT	231
17.4	Packet switched data configuration +UPSD.....	232
17.5	Packet switched data action +UPSDA.....	237
17.6	Packet switched network-assigned data +UPSND.....	238
17.7	Quality of service profile (requested) +CGQREQ.....	239
17.8	Quality of service profile (minimum acceptable) +CGQMIN.....	240
17.9	GPRS attach or detach +CGATT	241
17.10	PDP context activate or deactivate +CGACT	242
17.11	Manual response to a network request for PDP context activation +CGANS.....	245
17.12	Automatic Response to a Network Request for PDP Context Activation +CGAUTO.....	246
17.13	Enter data state +CGDATA.....	247
17.14	Enter IP state/GPRS IP dial D*.....	248
17.15	Show PDP address +CGPADDR.....	249
17.16	GPRS MS class configuration +CGCLASS.....	250
17.17	GPRS MS class configuration at start up +UCGCLASS.....	251
17.18	Device class setting +UCLASS	251
17.19	GPRS event reporting +CGEREP	253
17.20	GPRS network registration status +CGREG	255
17.21	Extended Packet Switched network registration status +UREG	256
17.22	Select service for MO SMS messages +CGSMS.....	257
17.23	Manual deactivation of a PDP context H	258
17.24	PDP Context Modify +CGCMOD.....	258
17.25	3G Quality of service profile (requested) +CGEQREQ	259



17.26	3G Quality of service profile (minimum acceptable) +CGEQMIN	261
17.27	3G Quality of Service Profile (negotiated) +CGEQNEG	263
17.28	Define Secondary PDP context +CGDSCONT	264
17.29	Always-On mode parameters settings +CGPERMSET	265
17.30	Always-On mode settings +CGPERMACT	265
17.31	Always-On mode check state +CGPERMSTATE	266
17.32	Traffic Flow Template +CGTFT	267
17.33	Read counters of sent or received PSD data +UGCNTRD	269
17.34	Set/reset counter of sent or received PSD data +UGCNTSET	269
17.35	Multiple PDP contexts	270
17.36	Primary and secondary PDP contexts	270
18.	System features	272
18.1	Firmware Install Command +UFWINSTALL	272
18.2	Firmware update Over AT command (FOAT) +UFWUPD	274
18.3	Antenna Detection +UANTR	275
18.4	ADC read command +UADC	276
18.5	Power saving control (Power SaVing) +UPSV	276
18.6	End User Test +UTEST	278
18.7	Smart temperature Supervisor +USTS	284
18.8	MSPR profile handling configuration +UDCONF=40	285
18.9	Configure the Data Channel +UDATACHANNEL	286
18.10	Rx Diversity +URXDIV	287
18.11	RING line handling +URING	288
18.12	PPP/LCP silent mode configuration +UDCONF=0	288
18.13	IPv6 configuration +UDCONF=66	289
19.	GPIO	290
19.1	Introduction	290
19.2	GPIO select configuration command +UGPIOC	296
19.3	GPIO read command +UGPIOR	298
19.4	GPIO set command +UGPIOW	298
20.	File System	300
20.1	Download file +UDWNFILE	300
20.2	Delete file +UDELFIL	301
20.3	Read file +URDFIL	301
20.4	List files information +ULSTFIL	302



20.5	Partial download file +URDBLOCK	303
21.	Audio interface	304
21.1	Audio path mode setting (Set Path Mode) +USPM	304
21.2	I ² S digital interface mode +UI2S	309
21.3	Play audio resource (Play Audio Resource) +UPAR.....	316
21.4	Stop audio resource (Stop Audio Resource) +USAR	318
21.5	Play audio file +UPLAYFILE	318
21.6	Stop audio file +USTOPFILE.....	320
21.7	Tone generator (Tone GeNerator) +UTGN	320
21.8	Ringing tone selection +URNNG	321
21.9	SMS alert sound mode (Message Sound Muting) +UMSM.....	322
21.10	Master Clock Control +UMCLK	323
21.11	External Device Configuration +UEXTDCONF.....	324
21.12	Speech codec configuration +UDCONF=30.....	325
22.	Audio parameters tuning.....	327
22.1	Introduction	327
22.2	Microphone gain (Microphone Gain Control) +UMGC.....	332
22.3	Speaker Gain (Speaker Gain Control) +USGC	334
22.4	Sidetone (SideToNe) +USTN	336
22.5	Uplink Digital Filters (Uplink Biquad Filters) +UUBF	337
22.6	Downlink Digital Filters (Downlink Biquad Filters) +UDBF.....	339
22.7	Hands-Free Parameters (Hands-Free Parameters) +UHFP	342
23.	DNS	349
23.1	Resolve Name / IP Number through DNS +UDNSRN	349
23.2	Dynamic DNS update +UDYNDNS.....	350
24.	TCP/IP UDP/IP.....	353
24.1	Introduction	353
24.2	Create Socket +USOCR	353
24.3	Set Socket Option +USOSO.....	354
24.4	Get Socket Option +USOGO.....	355
24.5	Close Socket +USOCL.....	357
24.6	Get Socket Error +USOER.....	357
24.7	Connect Socket +USOCO	358
24.8	Write Socket Data +USOWR	358
24.9	Send To command (UDP only) +USOST.....	360



- 24.10 Read Socket Data +USORD 362
- 24.11 Receive From command (UDP only) +USORF 363
- 24.12 Set Listening Socket +USOLI 364
- 24.13 Firewall control +UFRW 365
- 24.14 HEX mode configuration+UDCONF=1 366
- 24.15 Set socket in Direct Linkmode +USODL 367
- 24.16 UDP Direct LinkPacket Size configuration +UDCONF=2 369
- 24.17 UDP Direct LinkSending timer configuration +UDCONF=3 369
- 24.18 Timer Trigger configuration for Direct Link+UDCONF=5 370
- 24.19 Data Length Trigger configuration for Direct Link +UDCONF=6..... 370
- 24.20 Character Trigger configuration for Direct Link+UDCONF=7 371
- 24.21 Congestion timer configuration for Direct Link+UDCONF=8 371
- 24.22 Socket Control +USOCTL 372
- 24.23 IP Change Notification +UIPCHGN..... 373
- 24.24 Socket Always On +USOAO..... 377
- 25. FTP..... 382
 - 25.1 FTP service configuration +UFTP 382
 - 25.2 FTP command +UFTPC 384
 - 25.3 FTP Unsolicited Data URC +UUFTPCD..... 386
 - 25.4 FTP Command Result URC +UUFTPCR..... 386
 - 25.5 FTP error +UFTPER..... 387
- 26. HTTP 388
 - 26.1 HTTP control +UHTTP..... 388
 - 26.2 HTTP command +UHHTPC 390
 - 26.3 HTTP protocol error +UHHTPER..... 392
- 27. SMTP 393
 - 27.1 SMTP control +USMTP 393
 - 27.2 SMTP mail control +USMTPM..... 394
 - 27.3 SMTP command +USMTPC..... 396
 - 27.4 SMTP error +USMTPER..... 397
- 28. PING 398
 - 28.1 Ping command +UPING..... 398
 - 28.2 ICMP echo reply configuration +UDCONF=4 400
- 29. GNSS 401
 - 29.1 NMEA..... 401



29.2	GNSS power management +UGPS	401
29.3	Assisted GNSS unsolicited indication +UGIND	403
29.4	GNSS profile configuration +UGPRF	405
29.5	AssistNow Online configuration +UGAOP	406
29.6	AssistNow Offline configuration +UGAOF.....	407
29.7	Aiding server configuration +UGSRV.....	408
29.8	GNSS aiding request command +UGAOS	410
29.9	Send of UBX string +UGUBX	410
29.10	GNSS indications timer +UGTMR	411
29.11	Get GNSS Time and date +UGZDA	412
29.12	Get GNSS fix data +UGGGA	413
29.13	Get geographic position +UGGLL.....	414
29.14	Get number of GNSS satellites in view +UGGSV.....	414
29.15	Get recommended minimum GNSS data +UGRMC	415
29.16	Get course over ground and ground speed +UGVTG	416
29.17	Get satellite information +UGGSA	417
29.18	Ask for localization information +ULOC.....	417
29.19	Configure GNSS sensor +ULOCGNSS	419
29.20	Configure cellular location sensor (CellLocate [®]) +ULOCCELL.....	421
30.	DTMF	423
30.1	DTMF detection +UDTMFD	423
30.2	User setting for proactive DTMF tone generation +UDTMF	424
30.3	Local DTMF tone generation configuration +UDCONF=31.....	425
31.	eCall.....	426
31.1	Introduction	426
31.2	eIM sends and receives data +UECALLDATA	427
31.3	IVS eIM voice control +UECALLVOICE	429
31.4	eCall configuration +UECALLSTAT	432
31.5	eCall and InBM test configuration +UDCONF=90	433
31.6	eCall type +UECALLTYPE	435
31.7	Initiate eCall +CECALL	436
32.	SAP	437
32.1	Introduction	437
32.2	SAP mode activation +USAPMODE	437
32.3	SAP mode indications +USAPIND	438



A Appendix: Error codes.....	440
B Appendix: ATCommands List.....	459
C Appendix: UDP Direct Linkworkflow	481
D Appendix: Glossary	483



1. AT command settings

u-blox cellular modules provide at least one physical serial interface, which is compliant to V.24ter. At the module power on the module enter the command mode. For more details on command mode see the [Chapter 1.1](#).

For module and hyper terminal connection and settings see the corresponding Evaluation Kit User Guide.

1.1 Definitions

In this document the following naming conventions are used:

- DCE (Data Communications Equipment) or MT (Mobile Terminal): u-blox cellular module
- DTE (Data Terminal Equipment) or TE (Terminal Equipment): terminal that issues the command to the module

The terms DCE and DTE are used in the serial interface context.

u-blox cellular modules can implement more than one interface between DTE and DCE, either virtual interfaces (multiplexer channels) or physical interfaces (UART, USB, SPI, etc., when available). Each interface works as specified by the followings definitions. If not differently stated, all the subsequent descriptions are applicable to each interface.

[Appendix B.5](#) describes the different behaviour among the interfaces in reference to the AT command interface.

The DCE/MT interface can operate in these modes:

- **Command mode:** the DCE waits for AT command instructions. The DCE interprets all the characters received as commands to execute. The DCE may send responses back to the DTE indicating the outcome of the command or further information without having received any commands by the DTE (e.g. unsolicited response code - URC). Any communication in the command mode (in both directions) is terminated by the command line termination character.
- **Data mode:** the DCE transfers data after having sent the "CONNECT" string; all the characters sent to the DCE are intended to be transmitted to the remote party. Any further characters received over the serial link are deemed to be from the remote party, and any characters sent are transmitted to the remote party. The DCE enters data mode immediately after it makes a CSD or PSD connection.
- **Online command mode:** the DCE has a data connection established with a remote party, but treats signals from the DTE as command lines and sends back responses and unsolicited indications to the DTE.

It is possible to switch from data mode to online command mode (when a data connection is established) in the following ways:



- with the escape sequence: for more details see the [Chapter 14.11](#)
- via a DTR ON to OFF transition: for more details see the [Table 6](#) and the [Table 7](#)

To switch back to data mode from online command mode *ATO* command is used. For more details see also the *&D* command.

1.1.1 Command description

The AT commands configure and enable the cellular module functionalities according to 3GPP normative and u-blox specifications. The AT commands are issued to the module via a hyper terminal through a command line and are described in the following sections. A general description of each command is provided including the functionalities, the correct syntax to be provided by the TE/DTE, the allowed responses and an example. The command description defines each named parameter with its type, its range (valid/ acceptable values), the default value (when available) and the factory-programmed setting (when applicable).

The summary table on the top of each command section and the [Appendix B](#) lists all the u-blox cellular modules that support that command.

-  The example provided in the command description refers only to the handling provided by the command. It may be not valid for all the products which the document is applied to. The list of allowed values for a specific product is provided in the corresponding "Defined values" section.
-  In this document <CR><LF> are intentionally omitted into the command syntax.
-  If a parameter is omitted, no value will be inserted between the two commas indicating the interested parameter in the command line sent by the DTE.

1.1.2 Default values

If the command parameters are optional, they can be left out in the command line. If not otherwise specified, the default values are assumed as follows:

- For parameters of type Number, the default value is 0
- For parameters of type String, the default value is an empty string



1.1.3 Command line

The AT commands are typically issued to the cellular modules using a command line with the following generic syntax:

"AT"<command_name><string><S3_character>

Where:

- "AT": prefix to be set at the beginning of each command line
- <command_name>: command name string; it can have a "+" character as prefix
- <string>: string consisting of the value parameters following the syntax provided in this manual
The following rules are used when describing the command syntax:
 - o <...>: the name in angle brackets is a parameter. The brackets themselves do not appear in the command line
 - o [...]: the square brackets represent the optional parameters of a command or an optional part of the DCE information text response. Brackets themselves do not appear in the command line. When a parameter is not given, the value will be set to the default value provided in the command description
- <S3_character>: command line termination character; it can be set with *ATS3* command; the factory-programmed termination character is <CR>

-  The maximum number of characters which can be accepted on a single command line is 512. The DTE (used to send the characters) may further limit this number.
-  The command line is not case sensitive unless autobauding is enabled; in this case the prefix "AT" must be typed either as "AT" or "at"; other combinations ("aT" or "Ta") are not allowed.
-  When writing or sending an SMS, Ctrl-Z or ESC terminates the command; <CR> is used between the two parts of the SMS (address and text).

More than one AT command can be entered on the same command line. The "AT" prefix must be provided only at the beginning of the command line. Each command must be separated by using a semicolon as delimiter only if the command has a "+" character as prefix.

Example: AT&VE1;+CMGF?;+COPS?<CR>

If a command in the command line causes an error, or is not recognized as a valid command, then the execution is terminated, the remaining commands in the command line are ignored and an error result code is returned.

If all the commands are correctly executed, only the OK result code of the last command is returned.

-  Not all the commands can be entered with other commands on the same command line: *+CMGW*, *+CMGS*, *+USOWR*, *+USOST*, *+UDWNFILE* must be used by themselves.

The serial interface driver generally does not allow a new command until the previous one has been terminated by "OK" or by an error message. In specific cases (see the abortability attribute), the command execution may be aborted if a character is sent to DCE before the command has ended.

1.1.4 Information text responses and result codes

The response format can be set with the *ATV* command. The factory-programmed setting (ATV1, i.e. verbose) is as follows:

- Information text responses: <S3_character><S4_character><text><S3_character><S4_character>
- Result codes: <S3_character><S4_character><verbose code><S3_character><S4_character>

where

- <S3_character> is the command line termination character; it can be set with *S3* command
- <S4_character> is the linefeed character; it can be set with *S4* command

If the command line is successfully processed and the commands correctly executed, in verbose response format the string "OK" is sent as final result code.

Intermediate outputs as well as descriptive outputs of a command are formatted as information text responses; if more than one string has to be printed out (see for example *+UPSD* command description), additional command line termination and linefeed characters may be inserted for sake of readability.

If the command is not accepted by the MT an error result code will be displayed. The *AT+CMEE* command configures the format of the error result code. In this manual it is assumed that AT+CMEE=2, which results in error result code of the format:

- +CMS ERROR: <err>

for SMS-related AT commands, and for any other AT command of the format:

- +CME ERROR: <err>

where <err> represents the verbose result code.

The most typical error result codes are the following:

- If the command is not supported or unknown, either "+CME ERROR: unknown" or "+CME ERROR: operation not supported" is sent
- If the command syntax is wrong, "+CME ERROR: operation not supported" is sent ("+CMS ERROR: operation not supported" for SMS related commands)

The list of all the possible error result codes is available in [Appendix A.7](#) and [Appendix A.8](#). For some commands only the "ERROR" final result code is displayed and is documented in the command description.



The proprietary AT commands supporting the following features may trigger different operations:

- FTP, HTTP, SMTP, TCP and UDP connections: see the section [Appendix A.1](#), [Appendix A.1.1](#), [Appendix A.1.2](#), [Appendix A.1.3](#), [Appendix A.3](#)
- PING: see the [Appendix A.2](#)
- DNS: see the [Appendix A.3](#) and [Appendix A.4](#)
- IP change notification: see the [Appendix A.5](#)
- Firmware update Over AT command and over the air: see the [Appendix A.6](#) and [Appendix A.10](#)

The corresponding sections provide more details for retrieving the error result codes for these operations.

1.2 Profiles

Several user settings may be stored in the cellular module's memory. Some are directly stored in the non volatile memory (NVM), while the others are organized into two personal profiles. The first profile is the default profile, whose data is by default loaded during the module's power on.

[Appendix B.2](#) lists the complete settings that can be directly stored in NVM and the corresponding commands.

[Appendix B.1](#) lists the complete settings stored in the profiles and the corresponding commands.

More details about loading, storing and updating profiles can be found in the command descriptions for: [ATZ](#), [AT&F](#), [AT&W](#), [AT&V](#), and [AT&Y](#).

1.3 S-parameters

The S-parameters, as specified in ITU-T recommendation V250 [20], constitute a group of commands that begin with the string "ATS". They are generally indicated as S registers and are used to configure the way the module operates. Their syntax is:

ATS<parameter_number>?

ATS<parameter_number>=<value>

The number following the "ATS" is the referenced S parameter.

u-blox cellular modules support the following set of S-parameters (<parameter_number>):

- 0: automatic answer setting (for more details see the [S0](#))
- 2: escape character setting (for more details see the [S2](#))
- 3: command line termination character setting (for more details see the [S3](#))
- 4: response formatting character setting (for more details see the [S4](#))
- 5: command line editing character setting (for more details see the [S5](#))
- 6: pause before blind dialling setting (for more details see the [S6](#))
- 7: connection completion timeout setting (for more details see the [S7](#))
- 8: command dial modifier time setting (for more details see the [S8](#))
- 10: automatic disconnect delay setting (for more details see the [S10](#))
- 12: escape prompt delay setting (for more details see the [S12](#))



If a <parameter_number> other than those listed above is introduced, the S command returns ERROR (+CME ERROR: operation not supported).



2. General operation

2.1 Start up and initialization

A complete start up can take place only with a SIM card with disabled PIN check. For a SIM card with enabled PIN check, most commands answers with "+CME ERROR: SIM-PIN requested". After entering the PIN via the **+CPIN** command, which allows a start up completion, a lot of SIM files will be read: it is possible that some commands are affected by this preliminary phase, resulting in a temporary error response.

2.2 AT commands types

2.2.1 Action command

An action command forces the DCE to print information text or execute a specific action for the command. A typical example of this command type is the provision of the factory-programmed settings of the DCE like manufacturer name, firmware version, etc.

2.2.2 Set command

A set command configures the preferred settings for the interested command. The set command is the only way to set the preferred settings in the DCE. For some commands it is possible to store the current settings in the profile or in the non volatile memory and retrieve them in another connection.

2.2.3 Read command

A read command provides the current setting of the command parameters. It is used to find out the current command configuration.

2.2.4 Test command

A test command provides the list of the values allowed by each parameter of the command.

2.2.5 Unsolicited Result Code (URC)

An unsolicited result code is a string message (provided by the DCE) that is not triggered as a information text response to a previous AT command and can be output, when enabled, at any time to inform the DTE of a specific event or status change. The URC can have the same name of the command that enables it (e.g. **+CREG**) or can be enabled by another command (e.g. the **+CMTI** URC must be enabled by **AT+CNMI** AT command).

2.2.5.1 URCs presentation deferring

Since the URCs are text responses issued by the DCE without being requested by the DTE, their occurrence is completely uncorrelated to an AT command execution. Therefore, a collision between a URC and an AT command response might occur and it may lead the DTE to misunderstand the URC as part of the AT command's text response or viceversa.

The module avoids this collision by delaying the URCs presentation in case the AT command interface is busy. The AT command interface can be busy in the following cases:

- During a data call (data mode)
- During the execution of an AT command in command or online command mode

The command execution starts when the command line is completed by the command line termination character and the AT interpreter in the module accepts it; the command execution ends when the final result code for the command is sent out. Inside this period, the module is not allowed to send the not buffered URCs. For most of the messages, the DCE needs to be configured whether or not to send a URC. After enabling, for most of the URCs, if the AT command interface is busy, the pending URCs are buffered and their sending to

the DCE is deferred. The RING indication is always generated as an unsolicited result code. The NO CARRIER indication is generated as an unsolicited result code when it has not to be considered the final response for the executing command (e.g.: ATH); in case it is handled as an unsolicited result code, it follows the rule of the other URCs.

Generally, the buffered URCs are sent to the terminal as soon as the terminal exits the data mode or the command execution is terminated. An exception to this behavior is implemented for the following URCs classes:

- Reception of a new SMS related URCs, whose configuration is done via *AT+CNMI* command
- +CIEV URCs, whose configuration is done via *AT+CMER* command
- +CGEV URCs, whose configuration is done via *AT+CGEREP* command

For the above three classes, it is possible to select the presentation strategy in case of AT interface busy according the 3GPP 27.007 Technical Specification [2]; the buffering or discarding are the two possible choices (URCs are lost in the latter case). This is done via a proper configuration command (see *AT+CNMI*, *AT+CMER* and *AT+CGEREP* commands description). If the URCs are enabled or for the three described classes of URCs, the buffered URCs are sent out only when the AT interface is in idle again; this occurs as soon as:

- The data mode is released (the data call is disconnected)
- The final result code for an AT command is issued



LEON-G1

The module does not support the full URCs buffering/deferring capability: only the presentation deferring of the three above specified URCs classes is supported.



The DTE should wait some time (the recommended value is at least 20 ms) after the reception of an AT command final result code or URC before issuing a new AT command to give the DCE the opportunity to transmit the buffered URCs. Otherwise the collision of the URCs with the subsequent AT command is still possible.



In case multiple AT interfaces are available, it is in any case suggested to exclusively dedicate an AT interface to the URCs presentation. In this way, deferring is not experienced, and there is no risk of losing any URCs (buffering capabilities are actually limited).

2.2.6 Intermediate Result Code (IRC)

An intermediate result code is a string message (provided by the DCE) which provides to the DTE some information about the processing status of the pending AT command.

3. IPC - Inter Processor Communication

3.1 Multiplexing mode +CMUX

+CMUX						
Modules	LEON-G SARA-G					
	LISA-U SARA-U					
Attributes	Syntax	PIN required	Settings saved	Can be aborted	Response time	Error reference
	partial	No	No	No	-	+CME Error

3.1.1 Description

Enables the multiplexing protocol control channel as defined in 3GPP TS 27.010 [46]. The command sets the parameters for the control channel. The result code is returned using the old interface speed. The parameters become active only after sending the OK result code.

The usage of +CMUX command during the multiplexing is not allowed.

The multiplexer configuration is as follows:

- Channel 0: control channel
- Channel 1 - 5: AT commands / data connection
- Channel 6: GNSS tunnelling
- Channel 7: SAP (SIM Access Profile)

3.1.2 Syntax

Type	Syntax	Response	Example
Set	AT+CMUX=<mode>[,<subset>[,<port_speed>[,<N1>[,<T1>[,<N2>[,<T2>[,<T3>[,<k>]]]]]]]	OK	AT+CMUX=0,0,,1500,50,3,90 OK
Read	AT+CMUX?	+CMUX: <mode>[,<subset>[,<port_speed>,<N1>,<T1>,<N2>,<T2>,<T3>[,<k>] OK	+CMUX: 0,0,0,1500,253,3,254,0,0 OK
Test	AT+CMUX=?	+CMUX: (list of supported <mode>s), (list of supported <subset>s), (list of supported <port_speed>s), (list of supported <N1>s), (list of supported <T1>s), (list of supported <N2>s), (list of supported <T2>s), (list of supported <T3>s), (list of supported <k>s) OK	+CMUX: (0),(0),,(1-1509),(1-255),(0-5),(2-255),, OK

3.1.3 Defined values

Parameter	Type	Description
<mode>	Number	Multiplexer Transparency Mechanism: <ul style="list-style-type: none"> • 0: Basic option
<subset>	Number	The way in which the multiplexer control channel is set up: <ul style="list-style-type: none"> • 0: UIH frames used only (default)
<port_speed>	Number	Transmission rate. The allowed range is 0-7. This parameter is ignored and the value 0 is always displayed in case of read command.
<N1>	Number	Maximum frame size <ul style="list-style-type: none"> • Allowed range is 1-1509 • Default value is 31
<T1>	Number	Acknowledgement timer in units of ten milliseconds. The allowed range is 1-255.



Parameter	Type	Description
		This parameter is ignored and the value 253 is always set.
<N2>	Number	Maximum number of re-transmissions <ul style="list-style-type: none">• Allowed range is 0-5• Default value is 3
<T2>	Number	Response timer for the multiplexer control channel in units of ten milliseconds. The allowed range is 2-255. This parameter is ignored and the value 254 is always set
<T3>	Number	Wake up response timer. The allowed range is 0-255. This parameter is ignored and the value 0 is always displayed in case of the read command.
<k>	Number	Window size, for Advanced operation with Error Recovery options. The allowed range is 0-255. This parameter is ignored and the value 0 is always displayed in case of the read command

3.1.4 Notes

- If the multiplexer protocol is not started (the +CMUX set command has not been issued or returned ERROR) and *AT+CMEE* is set to 2, the +CMUX read command returns the following error result code: +CME ERROR: operation not allowed.
- For complete compatibility between u-blox products, leave the unsupported/unused parameters blank (which are reported as blank by the +CMUX test command).
- <T1> must be lower than or equal to <T2>.

LISA-U1 / LISA-U200-00S

- The SAP channel is not supported.

SARA-G

- The SAP channel is not supported.
- The range of <T2> is 0-255 (0 means that the timer is ignored).

SARA-G300 / SARA-G310

- The multiplexer configuration is as follows:
 - o Channel 0: control channel
 - o Channel 1 - 2: AT commands / data connection

LEON-G

- The SAP channel is not supported.
- The range of <T2> is 0-255 (0 means that the timer is ignored).
- The requested <N1> value is correctly set, but the +CMUX read command returns a value higher (<N1>+6 or <N1>+7), since it returns the maximum multiplexer protocol frame size (including the 6 or 7 bytes of the frame header). This does not affect the multiplexer protocol behavior, which uses the requested value.

LEON-G100-06S

- <port_speed>, <T3> and <k> can only assume the value 0.

4. General

4.1 Manufacturer identification +CGMI

+CGMI						
Modules	LEON-G SARA-G					
	LISA-U SARA-U					
Attributes	Syntax	PIN required	Settings saved	Can be aborted	Response time	Error reference
	full	No	No	No	-	+CME Error

4.1.1 Description

Text string identifying the manufacturer.

4.1.2 Syntax

Type	Syntax	Response	Example
Action	AT+CGMI	<manufacturer> OK	u-blox OK
Test	AT+CGMI=?	OK	

4.1.3 Defined values

Parameter	Type	Description
<manufacturer>	String	Manufacturer name

4.2 Model identification +CGMM

+CGMM						
Modules	LEON-G SARA-G					
	LISA-U SARA-U					
Attributes	Syntax	PIN required	Settings saved	Can be aborted	Response time	Error reference
	full	No	No	No	-	+CME Error

4.2.1 Description

Text string identifying the model identification.

4.2.2 Syntax

Type	Syntax	Response	Example
Action	AT+CGMM	<model> OK	LISA-U200 OK
Test	AT+CGMM=?	OK	

4.2.3 Defined values

Parameter	Type	Description
<model>	String	Name of model

4.3 Firmware version identification +CGMR

+CGMR						
Modules	LEON-G SARA-G					
	LISA-U SARA-U					
Attributes	Syntax	PIN required	Settings saved	Can be aborted	Response time	Error reference
	full	No	No	No	-	+CME Error

4.3.1 Description

Returns the firmware version of the module.

4.3.2 Syntax

Type	Syntax	Response	Example
Action	AT+CGMR	<version> OK	11.40 OK
Test	AT+CGMR=?	OK	

4.3.3 Defined values

Parameter	Type	Description
<version>	String	Firmware version

4.4 IMEI identification +CGSN

+CGSN						
Modules	LEON-G SARA-G					
	LISA-U SARA-U					
Attributes	Syntax	PIN required	Settings saved	Can be aborted	Response time	Error reference
	full	No	No	No	-	+CME Error

4.4.1 Description

Returns the product serial number, IMEI (International Mobile Equipment Identity) of the MT.

4.4.2 Syntax

Type	Syntax	Response	Example
Action	AT+CGSN	<IMEI> OK	004999010640000 OK
Test	AT+CGSN=?	OK	

4.4.3 Defined values

Parameter	Type	Description
<IMEI>	String	IMEI

4.5 Manufacturer identification +GMI

+GMI						
Modules	LEON-G SARA-G					
	LISA-U SARA-U					
Attributes	Syntax	PIN required	Settings saved	Can be aborted	Response time	Error reference
	full	No	No	No	-	+CME Error

4.5.1 Description

Text string identifying the manufacturer.

4.5.2 Syntax

Type	Syntax	Response	Example
Action	AT+GMI	<manufacturer> OK	u-blox OK

4.5.3 Defined values

Parameter	Type	Description
<manufacturer>	String	Manufacturer name

4.6 Model identification +GMM

+GMM						
Modules	LEON-G SARA-G					
	LISA-U SARA-U					
Attributes	Syntax	PIN required	Settings saved	Can be aborted	Response time	Error reference
	full	No	No	No	-	+CME Error

4.6.1 Description

Text string identifying the model identification.

4.6.2 Syntax

Type	Syntax	Response	Example
Action	AT+GMM	<model> OK	LISA-U120 OK

4.6.3 Defined values

Parameter	Type	Description
<model>	String	Name of model

4.7 Firmware version identification +GMR

+GMR						
Modules	LEON-G SARA-G					
	LISA-U SARA-U					
Attributes	Syntax	PIN required	Settings saved	Can be aborted	Response time	Error reference
	full	No	No	No	-	+CME Error

4.7.1 Description

Returns the firmware version of the module.

4.7.2 Syntax

Type	Syntax	Response	Example
Action	AT+GMR	<version> OK	11.40 OK

4.7.3 Defined values

Parameter	Type	Description
<version>	String	Firmware version

4.8 IMEI identification +GSN

+GSN						
Modules	LEON-G SARA-G					
	LISA-U SARA-U					
Attributes	Syntax	PIN required	Settings saved	Can be aborted	Response time	Error reference
	full	No	No	No	-	+CME Error

4.8.1 Description

Returns the IMEI (International Mobile Equipment Identity) of the MT.

4.8.2 Syntax

Type	Syntax	Response	Example
Action	AT+GSN	<IMEI> OK	355306040004097 OK
Test	AT+GSN=?	OK	

4.8.3 Defined values

Parameter	Type	Description
<IMEI>	String	IMEI

4.9 Identification information I

I						
Modules	LEON-G SARA-G					
	LISA-U SARA-U					
Attributes	Syntax	PIN required	Settings saved	Can be aborted	Response time	Error reference
	full	No	No	No	-	+CME Error

4.9.1 Description

Returns some module information as the module ordering code and the firmware version.



ATI9 returns the module firmware version and the application version of the module where applicable; it returns "Undefined" where not applicable.

4.9.2 Syntax

Type	Syntax	Response	Example
Action	Ordering code request	<ordering_code>	ATI0
	ATI[0]	OK	SARA-G350-00S-00 OK
Firmware and application version request	ATI9	<modem_version>,<applications_version>	ATI9 29.90,A01.00 OK
		OK	OK

4.9.3 Defined values

Parameter	Type	Description
<ordering_code>	String	Product ordering code
<modem_version>	String	Firmware module version
<applications_version>	String	Application module version. Where not applicable the module provides "Undefined"

4.10 TE character set configuration +CSCS

+CSCS						
Modules	LEON-G SARA-G					
	LISA-U SARA-U					
Attributes	Syntax	PIN required	Settings saved	Can be aborted	Response time	Error reference
	full	No	No	No	-	+CME Error

4.10.1 Description

Selects the TE character set.

4.10.2 Syntax

Type	Syntax	Response	Example
Set	AT+CSCS=<chset>	OK	AT+CSCS="IRA" OK
Read	AT+CSCS?	+CSCS:<chset> OK	+CSCS:"IRA" OK
Test	AT+CSCS=?	+CSCS:(list of supported <chset>'s) OK	+CSCS:("IRA","GSM","PCCP437", "8859-1","UCS2","HEX") OK

4.10.3 Defined values

Parameter	Type	Description
<chset>	String	<ul style="list-style-type: none"> "IRA" (factory-programmed value): International Reference Alphabet (ITU-T T.50) "GSM": GSM default alphabet (3GPP TS 23.038) "PCCP437": PC character set Code Page 437 "8859-1": ISO 8859 Latin 1 character set "UCS2": 16-bit universal multiple-octet coded character set (USO/IEC10646); UCS2 character strings are converted to hexadecimal numbers from 0000 to FFFF; e.g. "004100620063" equals three 16-bit characters with decimal values 65, 98 and 99 "HEX": character strings consist only of hexadecimal numbers from 00 to FF; e.g. "032FE6" equals three 8-bit characters with decimal values 3, 47 and 230; no conversions to the original MT character set shall be done

4.11 International mobile subscriber identification +CIMI

+CIMI						
Modules	LEON-G SARA-G					
	LISA-U SARA-U					
Attributes	Syntax	PIN required	Settings saved	Can be aborted	Response time	Error reference
	full	Yes	No	No	-	+CME Error

4.11.1 Description

Request the IMSI (International Mobile Subscriber Identity).

4.11.2 Syntax

Type	Syntax	Response	Example
Action	AT+CIMI	<IMSI> OK	222107701772423 OK
Test	AT+CIMI=?	OK	

4.11.3 Defined values

Parameter	Type	Description
<IMSI>	String	International Mobile Subscriber Identity

4.12 Card identification +CCID

+CCID						
Modules	LEON-G SARA-G					
	LISA-U SARA-U					
Attributes	Syntax	PIN required	Settings saved	Can be aborted	Response time	Error reference
	full	No	No	No	-	+CME Error

4.12.1 Description

Returns the ICCID (Integrated Circuit Card ID) of the SIM-card. ICCID is a serial number identifying the SIM.

4.12.2 Syntax

Type	Syntax	Response	Example
Action	AT+CCID	+CCID: <ICCID> OK	+CCID: 8939107800023416395 OK
Read	AT+CCID?	+CCID: <ICCID> OK	+CCID: 8939107900010087330 OK
Test	AT+CCID=?	OK	

4.12.3 Defined values

Parameter	Type	Description
<ICCID>	String	ICCID of the SIM card

4.12.4 Notes

- The command needs of the SIM to correctly work.

4.13 Request complete capabilities list +GCAP

+GCAP						
Modules	LEON-G SARA-G					
	LISA-U SARA-U					
Attributes	Syntax	PIN required	Settings saved	Can be aborted	Response time	Error reference
	full	No	No	No	-	+CME Error

4.13.1 Description

This command requests the list of capabilities, containing the corresponding command names. The Complete Capabilities List command indicates the major capability areas of the MT. Each area is presented by the selection command name of the specific capability area or some other predefined response.

The first response text (+FCLASS) informs that some fax or voice capabilities are present while the second supported area presented with +CGSM shows that all GSM commands of the present document are supported.

4.13.2 Syntax

Type	Syntax	Response	Example
Action	AT+GCAP	+GCAP: <capability_area 1>[, <capability_area 2>[...]] OK	+GCAP: +FCLASS, +CGSM OK
Test	AT+GCAP=?	OK	

4.13.3 Defined values

Parameter	Type	Description
<capability_area>	String	Command name or predefined response of the specific capability area

Parameter	Type	Description
		In the Example: +FCLASS response text informs that some fax or voice capabilities are present, while +CGSM response text shows that all GSM commands of the present document are supported by the MT

4.14 Repeat last command A/

A/						
Modules	LEON-G SARA-G					
	LISA-U SARA-U					
Attributes	Syntax	PIN required	Settings saved	Can be aborted	Response time	Error reference
	full	No	No	No	-	+CME Error

4.14.1 Description

Repeats the previously executed command again. Only the A/ command cannot be repeated.



If autobauding is active, the MT is not able to recognize the command and the command A/ cannot be used.

4.14.2 Syntax

Type	Syntax	Response	Example
Action	A/		

4.15 List all available AT commands +CLAC

+CLAC						
Modules	LEON-G SARA-G					
	LISA-U SARA-U					
Attributes	Syntax	PIN required	Settings saved	Can be aborted	Response time	Error reference
	full	No	No	No	-	+CME Error

4.15.1 Description

Causes the MT to return one or more lines of AT commands that are available for the DTE user. Each line contains one AT command.

4.15.2 Syntax

Type	Syntax	Response	Example
Action	AT+CLAC	<AT command 1> [<AT command 2> [...]] OK	
Test	AT+CLAC=?	OK	

4.15.3 Defined values

Parameter	Type	Description
<AT command>	String	AT command name



4.16 Help displaying all commands &H

&H						
Modules	LEON-G SARA-G					
	LISA-U SARA-U					
Attributes	Syntax	PIN required	Settings saved	Can be aborted	Response time	Error reference
	full	No	No	No	-	+CME Error

4.16.1 Description

This command lists all the supported commands.

4.16.2 Syntax

Type	Syntax	Response	Example
Action	AT&H	<AT command 1> : <AT command 1 title>[<CR><LF><AT command 2> : <AT command 2 title> [...] OK	ATA : Answer an Incoming Call ATE : Echo ATH : Hook Control ATV : Enable/Disable verbose response ... AT+UTEST : End User Test ATS : Query or Set an S-register ATD : Dial OK

4.16.3 Defined values

Parameter	Type	Description
<AT command n>	String	AT command name
<AT command n title>	String	AT command title

4.16.4 Notes

LEON-G / SARA-G

- The response is:
 <AT command 1>, <AT command 2>, ..., <AT command n>[,<CR><LF><AT command n+1>, ..., <AT command n+m>

[...]

OK

Example:

&W, &Y, A, B, E, H, I, L, M, O, P, Q, S0, S10, S12,

S2, S3, S4, S5, S6, S7, S8, T, V, X, Z, \Q,

...

+USORD, +USORF, +USOSO, +USOST, +USOWR, +USPM, +USTN,

+USTOPFILE, +USTS, +UTEST, +UTGN, +UUBF

OK

5. Mobile equipment control and status

5.1 Phone activity status +CPAS

+CPAS						
Modules	LEON-G SARA-G					
	LISA-U SARA-U					
Attributes	Syntax	PIN required	Settings saved	Can be aborted	Response time	Error reference
	full	No	No	No	-	+CME Error

5.1.1 Description

Returns the activity status <pas> of the MT.

5.1.2 Syntax

Type	Syntax	Response	Example
Action	AT+CPAS	+CPAS: <pas> OK	
Test	AT+CPAS=?	+CPAS: (list of supported <pas>s) OK	+CPAS: (0-5) OK

5.1.3 Defined values

Parameter	Type	Description
<pas>	Number	<ul style="list-style-type: none"> 0: ready (MT allows commands from DTE) 1: unavailable (MT does not allow commands from DTE) 2: unknown (MT is not guaranteed to respond to instructions) 3: ringing (MT is ready for commands from DTE, but the ringer is active) 4: call in progress (MT is ready for commands from DTE, but a call is in progress, e.g. call active, hold, disconnecting) 5: asleep (ME is unable to process commands from DTE because it is in a low functionality state)

5.2 Module switch off +CPWROFF

+CPWROFF						
Modules	LEON-G SARA-G					
	LISA-U SARA-U					
Attributes	Syntax	PIN required	Settings saved	Can be aborted	Response time	Error reference
	full	No	No	No	< 40 s	+CME Error

5.2.1 Description

Switches off the MT. During shut-down current settings are saved in module's non-volatile memory.



Using this command can result in the following command line being ignored.



Refer to the corresponding System Integration Manual for the timing and the electrical details of the module power-off sequence via the +CPWROFF command.

5.2.2 Syntax

Type	Syntax	Response	Example
Action	AT+CPWROFF	OK	
Test	AT+CPWROFF=?	OK	

5.3 Set phone functionality +CFUN

+CFUN						
Modules	LEON-G SARA-G					
	LISA-U SARA-U					
Attributes	Syntax	PIN required	Settings saved	Can be aborted	Response time	Error reference
	partial	No	No	No	Up to 3 min	+CME Error

5.3.1 Description

Selects level of functionality <fun> in the MT.



If the syntax +CFUN=15 or +CFUN=16 (resets) is used, the rest of the command line, placed after that, will be ignored.

5.3.2 Syntax

Type	Syntax	Response	Example
Set	AT+CFUN=<fun>[,<rst>]	OK	AT+CFUN=1 OK
Read	AT+CFUN?	+CFUN: <power_mode>,<STK_mode> OK	+CFUN: 1,0 OK
Test	AT+CFUN=?	+CFUN: (list of supported <fun>'s),(list of supported <rst>'s) OK	+CFUN: (0,1,4,6,7,8,15,16),(0-1) OK

5.3.3 Defined values

Parameter	Type	Description
<fun>	Number	Selected functionality <ul style="list-style-type: none"> 0: sets the MT to minimum functionality (disable both transmit and receive RF circuits) 1: sets the MT to full functionality, e.g. from airplane mode or minimum functionality (factory-programmed setting) 4: disables both transmit and receive RF circuits (i.e. "airplane mode") 6: enables the SIM-toolkit interface in dedicated mode and fetching of proactive commands by SIM-APPL from the SIM-card 7 or 8: disables the SIM-toolkit interface and enables fetching of proactive commands by SIM-APPL from the SIM-card 9: enables the SIM-toolkit interface in raw mode and fetching of proactive commands by SIM-APPL from the SIM-card 15: MT silent reset (with detach from network and saving of NVM parameters), without reset of the SIM card 16: MT silent reset (with detach from network and saving of NVM parameters), with reset of the SIM card
<rst>	Number	Reset mode. This parameter can be used only when <fun> is 1 or 4. <ul style="list-style-type: none"> 0 (default value): do not reset the MT before setting it to the selected <fun> 1: Perform a MT silent reset (with detach from network and saving of NVM parameters) with reset of the SIM card before setting it to the selected <fun>
<power_mode>	Number	<ul style="list-style-type: none"> 0: MT is switched on with minimum functionality 1: MT is switched on 4: MT is in "airplane mode"
<STK_mode>	Number	<ul style="list-style-type: none"> 6: the SIM-toolkit interface in dedicated mode and fetching of proactive commands by SIM-APPL from the SIM-card are enabled 0, 7 or 8: the SIM-toolkit interface is disabled; fetching of proactive commands by SIM-APPL from the SIM-card is enabled 9: the SIM-toolkit interface in raw mode and fetching of proactive commands by SIM-APPL from the SIM-card are enabled

5.3.4 Notes

LEON-G / SARA-G

- <fun>=4 is not supported (<fun>=0 can be used instead)
- <fun>=9 is not supported
- <fun>=15 behaves as <fun>=16: the MT is reset as well as the SIM card
- <rst>=1 can be used only if <fun>=1
- <STK_mode>=9 is not supported

5.4 Indicator control +CIND

+CIND						
Modules	LEON-G SARA-G					
	LISA-U SARA-U					
Attributes	Syntax	PIN required	Settings saved	Can be aborted	Response time	Error reference
	partial	No	No	No	-	+CME Error

5.4.1 Description

Provides indication states related to network status, battery information and so on.

The set command does not allow setting the values for those indications which are set according to module state (see <descr> parameter).

The list of indications for set and read commands follows the indexes reported in the <descr> parameter, so that the first <ind> corresponds to "battchg" and so on.

For more details refer to 3GPP 27.007 Technical Specification [2].

5.4.2 Syntax

Type	Syntax	Response	Example
Set	AT+CIND=[<ind>[,<ind>[...]]]	OK	AT+CIND= OK
Read	AT+CIND?	+CIND: <ind>[,<ind>[...]] OK	+CIND: 5,0,0,0,0,0,0,0,0,0 OK
Test	AT+CIND=?	+CIND: (list of <descr>s) OK	+CIND: ("battchg",(0-5)),("signal", ("service",(0,1)),("sounder", ("message",(0,1)),("call",(0,1)),("roam", ("smsfull",(0,1)),("gprs",(0-2)), ("callsetup",(0-3)),("callheld", ("simind",(0-2)) OK

5.4.3 Defined values

Parameter	Type	Description
<ind>	Number	Range of corresponding <descr> used to identify the service when an unsolicited indication is provided
<descr>	String	Reserved by the norm and their <ind> ranges; it may have the values: <ul style="list-style-type: none"> • "battchg": battery charge level (0-5) • "signal": signal quality. See mapping in the note below • "service": network service availability <ul style="list-style-type: none"> o 0: Not registered to any network o 1: Registered to the network o 65535: Indication not available • "sounder": sounder activity, indicating when the module is generating a sound <ul style="list-style-type: none"> o 0: no sound o 1: sound is generated • "message": Unread message available in <mem1> storage



Parameter	Type	Description
		<ul style="list-style-type: none"> o 0: no messages o 1: unread message available
		<ul style="list-style-type: none"> • "call": call in progress <ul style="list-style-type: none"> o 0: No call in progress o 1: Call in progress
		<ul style="list-style-type: none"> • "roam": Registration on a roaming network <ul style="list-style-type: none"> o 0: Not in roaming or not registered o 1: Roaming o 65535: Indication not available
		<ul style="list-style-type: none"> • "smsfull": Indication that an SMS has been rejected with the cause of SMS storage full <ul style="list-style-type: none"> o 0: SMS storage not full o 1: SMS Storage full
		<ul style="list-style-type: none"> • "gprs": GPRS indication status: <ul style="list-style-type: none"> o 0: No GPRS available in the network o 1: GPRS available in the network but not registered o 2: Registered to GPRS o 65535: Indication not available
		<ul style="list-style-type: none"> • "callsetup" : call set-up: <ul style="list-style-type: none"> o 0: no call set-up o 1: incoming call not accepted or rejected o 2: outgoing call in dialing state o 3: outgoing call in remote party alerting state
		<ul style="list-style-type: none"> • "callheld" : call on hold: <ul style="list-style-type: none"> o 0: no calls on hold o 1: at least one call on hold
		<ul style="list-style-type: none"> • "simind": SIM detection <ul style="list-style-type: none"> o 0: No SIM detected o 1: SIM detected o 2: not available

5.4.4 Notes

- If the battery charging is not supported, "battchg" always returns 5 (full charge).
- The <descr> values cannot be changed with +CIND set.
- The following mapping of "signal" value to <rssi> parameter (+CSQ AT command) exists:

"signal" value	<rssi> value	Power level
0	< 4 or 99	(< -105 dBm or unknown)
1	< 10	(< -93 dBm)
2	< 16	(< -81 dBm)
3	< 22	(< -69 dBm)
4	< 28	(< -57 dBm)
5	>=28	(>= -57 dBm)

LISA-U / SARA-U

- Opportunely configure the GPIO pin to enable the SIM detection status; for more details refer to [+UGPIOC](#) command description.

LEON-G / SARA-G300 / SARA-G310

- <descr>="simind" is not supported.

5.5 Configuration of indicator control +UCIND

+UCIND						
Modules	LISA-U SARA-U					
Attributes	Syntax	PIN required	Settings saved	Can be aborted	Response time	Error reference
	full	No	No	No	-	+CME Error

5.5.1 Description

Allows the configuration of unsolicited results for indications with +CIEV.

5.5.2 Syntax

Type	Syntax	Response	Example
Set	AT+UCIND=[<conf>]	OK	AT+UCIND=7 OK
Read	AT+UCIND?	+UCIND: <conf> OK	+UCIND: 7 OK
Test	AT+UCIND=?	OK	

5.5.3 Defined values

Parameter	Type	Description
<conf>	Number	The unsigned integer (0 to 4095) is a bitmask representing the list of the indications active for +CIEV URC reporting. The bit position corresponds to the indicator order number (refer to <descr> parameter of +CMER in Chapter 5.6). The least significant bit is used for the first indicator. The bits corresponding to unused indicator order numbers (greater than 13) must be set to 0 (setting a <conf> greater than 4095 causes an error). The default value is 4095 (all the indications are enabled).

5.6 Mobile termination event reporting +CMER

+CMER						
Modules	LEON-G SARA-G LISA-U SARA-U					
Attributes	Syntax	PIN required	Settings saved	Can be aborted	Response time	Error reference
	partial	No	No	No	-	+CME Error

5.6.1 Description

Enables or disables sending of URCs from MT to DTE for indications. <mode> parameter controls the processing of URCs specified within this command.

The URC is generated each time an indicator which is defined in +CIND command changes status. The code is actually submitted to MT according to the settings of +CMER.

The command +UCIND allows enabling or disabling indicators.

5.6.2 Syntax

Type	Syntax	Response	Example
Set	AT+CMER=[<mode>[,<keyp>[,<disp>[,<ind>[,<bfr>]]]]]	OK	AT+CMER=1,0,0,2,1 OK
Read	AT+CMER?	+CMER: <mode>,<keyp>,<disp>,<ind>,<bfr> OK	+CMER: 1,0,0,0,1 OK
Test	AT+CMER=?	+CMER: (list of supported <mode>'s),(list of supported <keyp>'s),(list of supported <disp>'s),(list of supported <ind>'s),(list of supported <bfr>'s)	+CMER: (0-3),(0),(0),(0-2),(0,1) OK

Type	Syntax	Response	Example
		OK	
URC		+CIEV: <descr>,<value>	

5.6.3 Defined values

Parameter	Type	Description
<mode>	Number	<ul style="list-style-type: none"> 0 (default value): buffer URCs in the MT 1: discard URCs when the V.24 interface is reserved for data; otherwise directly display them on the DTE 2: buffer URCs in MT when the V.24 interface is reserved and flush them after reservation; otherwise directly display them on the DTE 3: same as 1
<keyp>	Number	<ul style="list-style-type: none"> 0: no keypad event reporting
<disp>	Number	<ul style="list-style-type: none"> 0: no display event reporting
<ind>	Number	<ul style="list-style-type: none"> 0: no indicator event reporting 1: indicator event reporting using the +CIEV URC. Only the indicator events which are not caused by +CIND shall be indicated by the MT to the DTE. 2: indicator event reporting using the +CIEV URC. All the indicator events shall be directed from MT to DTE.
<bfr>	Number	<ul style="list-style-type: none"> 0: MT buffer of URCs defined within this command is cleared when <mode> 1...3 is entered 1: MT buffer of URCs defined within this command is flushed to the DTE when <mode> 1...3 is entered (the OK response shall be given before flushing the codes).
<descr>	Number	<p>Indicates the indicator order number. The name in the brackets indicates the corresponding <descr> parameter of +CIND (refer to Chapter 5.4); <value> is the new value of indicator</p> <ul style="list-style-type: none"> 1 ("battchg"): <value> provides the battery charge level (0-5) 2 ("signal"): <value> provides the signal quality <ul style="list-style-type: none"> 0: < -107 dBm 1: < -93 dBm 2: < -71 dBm 3: < -69 dBm 4: < -57 dBm 5: >= -57 dBm 3 ("service"): <value> provides the network service availability <ul style="list-style-type: none"> 0: not registered to the network 1: registered to the network 4 ("sounder"): <value> provides the sounder activity <ul style="list-style-type: none"> 0: no sound 1: sound is generated 5 ("message"): <value> provides the unread message available in <mem1> storage <ul style="list-style-type: none"> 0: no messages 1: unread message available 6 ("call"): <value> provides the call in progress <ul style="list-style-type: none"> 0: no call in progress 1: call in progress 7 ("roam"): <value> provides the registration on a roaming network <ul style="list-style-type: none"> 0: not in roaming 1: roaming 8 ("smsfull"): <value> provides the SMS storage status <ul style="list-style-type: none"> 0: SMS storage not full 1: SMS Storage full (an SMS has been rejected with the cause of SMS storage full) 9 ("gprs"): <value> provides the GPRS indication status: <ul style="list-style-type: none"> 0: no GPRS available in the network 1: GPRS available in the network but not registered 2: registered to GPRS 10 ("callsetup"): <value> provides the call set-up: <ul style="list-style-type: none"> 0: no call set-up 1: incoming call not accepted or rejected 2: outgoing call in dialing state

Parameter	Type	Description
		<ul style="list-style-type: none"> o 3: outgoing call in remote party alerting state
		<ul style="list-style-type: none"> • 11 ("callheld") : <value> provides the call on hold: <ul style="list-style-type: none"> o 0: no calls on hold o 1: at least one call on hold • 12 ("simind"): <value> provides the SIM detection <ul style="list-style-type: none"> o 0: no SIM detected o 1: SIM detected

5.6.4 Notes

LEON-G / SARA-G300 / SARA-G310

- <descr>=12 is not supported.

5.7 Clock +CCLK

+CCLK						
Modules	LEON-G SARA-G LISA-U SARA-U					
Attributes	Syntax	PIN required	Settings saved	Can be aborted	Response time	Error reference
	full	No	NVM	No	-	+CME Error

5.7.1 Description

Sets the real-time clock of the MT.

5.7.2 Syntax

Type	Syntax	Response	Example
Set	AT+CCLK=<time>	OK	AT+CCLK="14/07/01,15:00:00+01" OK
Read	AT+CCLK?	+CCLK: <time> OK	+CCLK: "14/07/01,15:00:00+01" OK
Test	AT+CCLK=?	OK	

5.7.3 Defined values

Parameter	Type	Description
<time>	String	Format is "yy/MM/dd,hh:mm:ss+TZ". Characters indicate year, month, day, hours, minutes, seconds, time zone. The factory-programmed value is "04/01/01,00:00:00+00". Values prior to the factory-programmed value are not allowed.

5.7.4 Notes

- If the parameter value is out of range, then the error message "+CME ERROR: operation not supported" will be provided (if +CMEE is set to 2).
- "TZ": The Time Zone information is represented by two digits. The value is updated during the registration procedure when the automatic time zone update is enabled (using [+CTZU](#) command) and the network supports the time zone information.
- The Time Zone information is expressed in steps of 15 minutes and it can assume a value in the range that goes from -96 to +96.

LEON-G / SARA-G340 / SARA-G350

- The PIN insertion is mandatory before the command execution.

5.8 Alarm +CALA

+CALA						
Modules	LEON-G SARA-G340 SARA-G350 LISA-U SARA-U					
Attributes	Syntax	PIN required	Settings saved	Can be aborted	Response time	Error reference
	full	No	<i>NVM</i>	No	-	+CME Error

5.8.1 Description

Sets an alarm time in the MT. There can be an array of different types of alarms. If the setting fails, a +CME ERROR: <error> is returned. To set up a recurrent alarm for more days in the week, the <recurr> parameter is used. When an alarm time is reached, the alarm actions are executed:

- Sound alarm (if not silent and if sound is supported)
- URC +CALV: <n> is displayed on DTE

5.8.2 Syntax

Type	Syntax	Response	Example
Set	AT+CALA=<time>[,<n>[,<type>[,<text>[,<recurr>[,<silent>]]]]]	OK	AT+CALA="02/07/01,14:56:00+04",1,1,"Alarm" OK
Read	AT+CALA?	[+CALA: <time>,<n1>,<type>[,<text>[,<recurr>],<silent>] [+CALA: <time>,<n2>,<type>[,<text>[,<recurr>],<silent>] [...]] OK	+CALA: "02/07/01,14:56:00+04",1,0,"Alarm",0 OK
Test	AT+CALA=?	+CALA: (list of supported <n>'s),(list of supported <type>'s),<tlength>,<rlength>,(list of supported <silent>'s) OK	+CALA: (1-3),,255,13,(0-1) OK
URC		+CALV: <n>	

5.8.3 Defined values

Parameter	Type	Description
<time>	String	Format is "yy/MM/dd, hh:mm:ss±TZ". Characters indicate year, month, day, hour, minutes, seconds, time zone.
<n>, <n1>, <n2>	Number	Indicates the index of the alarm, the allowed ranges are 1-3; if not indicated by user, default value 1 is assumed
<type>	Number	Type of the alarm; this parameter is ignored.
<text>	String	Indicates the text to be displayed when alarm time is reached; this parameter is ignored
<tlength>	Number	Indicates the maximum length of <text>; this parameter is ignored
<recurr>	String	Maximum string length is 13, indicates day of week for the alarm in one of the following formats: <ul style="list-style-type: none"> • "<1..7>[,<1..7>[...]]": Sets a recurrent alarm for one or more days in the week. The digits 1 to 7 corresponds to the days in the week, Monday (1), ..., Sunday (7). Example: The string "1,2,3,4,5" may be used to set an alarm for some weekdays. • "0": Sets a recurrent alarm for all days in the week and all following weeks
<rlength>	Number	Indicates the maximum length of <recurr>
<silent>	Number	Indicates if the alarm is silent or not <ul style="list-style-type: none"> • 1: the alarm will be silent and the only result from the alarm is the URC +CALV • 0: the alarm will not be silent



5.8.4 Switching off module after setting the alarm

The module can be switched off after setting the alarm, in which case the module switches on as soon as the alarm time is reached. The following is an example procedure using the alarm setting:

- Set the RTC clock by AT command: AT+CCLK="06/12/29,11:00:00+00" (you can check the time set by AT+CCLK?)
- Set the RTC alarm by AT command: AT+CALA="06/12/29,11:01:00+00",1,0,"","",0 (you can check the alarm set by AT+CALA?)
- Switch off the MT with AT+CPWROFF

Output: The MT switches on as soon as the minute is expired and answers "+CALV:1". Try to send "AT" on the hyper terminal, the MT replies properly.

5.8.5 Notes

- The alarm is not by default configured.

LEON-G / SARA-G340 / SARA-G350

- The PIN insertion is mandatory before the command execution.

5.9 Delete alarm +CALD

+CALD						
Modules	LEON-G SARA-G340 SARA-G350					
	LISA-U SARA-U					
Attributes	Syntax	PIN required	Settings saved	Can be aborted	Response time	Error reference
	full	No	No	No	-	+CME Error

5.9.1 Description

Deletes an alarm in the MT.

5.9.2 Syntax

Type	Syntax	Response	Example
Set	AT+CALD=<n>	OK	AT+CALD=1 OK
Test	AT+CALD=?	+CALD: (list of <n>s) OK	+CALD: (1-3) OK

5.9.3 Defined values

Parameter	Type	Description
<n>	Number	Indicates the index of the alarm; refer to +CALA description for the allowed range of indexes.

5.9.4 Notes

LEON-G / SARA-G340 / SARA-G350

- The PIN insertion is mandatory before the command execution.

5.10 Alert sound mode +CALM

+CALM						
Modules	LEON-G SARA-G340 SARA-G350 LISA-U120 LISA-U130 LISA-U200-01S LISA-U200-02S LISA-U200-52S LISA-U200-62S LISA-U200-82S LISA-U230 LISA-U260 LISA-U270 SARA-U					
Attributes	Syntax	PIN required	Settings saved	Can be aborted	Response time	Error reference
	partial	No	<i>NVM</i>	No	-	<i>+CME Error</i>

5.10.1 Description

Selects the general alert sound mode.

5.10.2 Syntax

Type	Syntax	Response	Example
Set	AT+CALM=<mode>	OK	AT+CALM=0 OK
Read	AT+CALM?	+CALM: <mode> OK	+CALM: 0 OK
Test	AT+CALM=?	+CALM: (list of supported <mode>s) OK	+CALM: (0-1) OK

5.10.3 Defined values

Parameter	Type	Description
<mode>	Number	<ul style="list-style-type: none"> 0 (factory-programmed value): normal mode 1: silent mode (ring tones and SMS tones are muted; <i>+UTGN</i> AT command is not supported)

5.10.4 Notes

- If +CALM is set to 1, the *+UTGN* command returns an error result code (+CME ERROR: operation not supported).
- If an incorrect number of parameters is provided or the parameter value is out of range, then the error result code "+CME ERROR: operation not supported" will be provided (if *+CMEE* is set to 2).

LEON-G / SARA-G340 / SARA-G350

- If +CALM is set to 1, the service tones (e.g.: Call Waiting tone) and alarm tone (see *+CALA* command) are also muted; furthermore the *+UPLAYFILE* and *+UPAR* commands return an error result code (+CME ERROR: operation not supported).

5.11 Ringer sound level +CRSL

+CRSL						
Modules	LEON-G SARA-G340 SARA-G350 LISA-U120 LISA-U130 LISA-U200-01S LISA-U200-02S LISA-U200-52S LISA-U200-62S LISA-U200-82S LISA-U230 LISA-U260 LISA-U270 SARA-U					
Attributes	Syntax	PIN required	Settings saved	Can be aborted	Response time	Error reference
	partial	No	<i>NVM</i>	No	-	<i>+CME Error</i>

5.11.1 Description

Selects the sound level for the ringer of an incoming call and for the tone generator (refer to *+UPAR* command).

5.11.2 Syntax

Type	Syntax	Response	Example
Set	AT+CRSL=[<level>]	OK	AT+CRSL=2

Type	Syntax	Response	Example
Read	AT+CRSL?	+CRSL: <level> OK	+CRSL: 2 OK
Test	AT+CRSL=?	+CRSL: (list of supported <level>s) OK	+CRSL: (0-5) OK

5.11.3 Defined values

Parameter	Type	Description
<level>	Number	Range 0-5 (0 means mute). The default value and factory-programmed value is 4.

5.11.4 Notes

- If an incorrect number of parameters is provided or the parameter value is out of range, then the error message "+CME ERROR: operation not supported" will be provided (if +CMEE is set to 2).

LISA-U1

- If +CRSL is set to 0, the AMR player (refer to [+UPLAYFILE](#) command) is muted.

LEON-G / SARA-G340 / SARA-G350

- The <level> parameter is mandatory.
- If +CRSL is set to 0, the [+UPLAYFILE](#) command returns an error message (+CME ERROR: operation not supported).
- The command also selects the volume of the MIDI player (refer to [+UPAR](#) command), the AMR player (refer to [+UPLAYFILE](#) command), the service tones (e.g.: Call Waiting tone) and the alarm tone (refer to [+CALA](#) command).

5.12 Loudspeaker volume level +CLVL

+CLVL						
Modules	LEON-G SARA-G340 SARA-G350					
	LISA-U120 LISA-U130 LISA-U200-01S LISA-U200-02S LISA-U200-52S LISA-U200-62S LISA-U200-82S LISA-U230 LISA-U260 LISA-U270 SARA-U					
Attributes	Syntax	PIN required	Settings saved	Can be aborted	Response time	Error reference
	partial	No	NVM	No	-	+CME Error

5.12.1 Description

Selects the speech volume.

5.12.2 Syntax

Type	Syntax	Response	Example
Set	AT+CLVL=[<level>]	OK	AT+CLVL=30 OK
Read	AT+CLVL?	+CLVL: <level> OK	+CLVL: 80 OK
Test	AT+CLVL=?	+CLVL: (list of supported <level>s) OK	+CLVL: (0-100) OK

5.12.3 Defined values

Parameter	Type	Description
<level>	Number	0-100 (0 means mute). The default and factory-programmed value is 80 100 means +6 dB; the step size is 0.5 dB; e.g.: 80 means -4 dB

5.12.4 Notes

- If an incorrect number of parameters is provided or the parameter value is out of range, then the error message "+CME ERROR: operation not supported" will be provided (if +CMEE is set to 2).
- +CLVL affects only the speech volume during the call. Other players volume and tone generator volume are not affected.

LEON-G / SARA-G340 / SARA-G350

- The <level> parameter is mandatory. Moreover <level>= 100 means 0 dB and the step size is 0.25 dB (e.g.: 80 means -5 dB).

5.13 Mute control +CMUT

+CMUT						
Modules	LEON-G SARA-G340 SARA-G350					
	LISA-U120 LISA-U130 LISA-U200-01S LISA-U200-02S LISA-U200-52S LISA-U200-62S LISA-U200-82S LISA-U230 LISA-U260 LISA-U270 SARA-U					
Attributes	Syntax	PIN required	Settings saved	Can be aborted	Response time	Error reference
	full	No	No	No	-	+CME Error

5.13.1 Description

Enables and disables the uplink voice muting during all the voice calls.

5.13.2 Syntax

Type	Syntax	Response	Example
Set	AT+CMUT=<n>	OK	AT+CMUT=0 OK
Read	AT+CMUT?	+CMUT: <n> OK	+CMUT: 0 OK
Test	AT+CMUT=?	+CMUT: (list of supported <n>s) OK	+CMUT: (0-1) OK

5.13.3 Defined values

Parameter	Type	Description
<n>	Number	<ul style="list-style-type: none"> • 0: mute off (default value) • 1: mute on

5.13.4 Notes

- If an incorrect number of parameters is provided or the parameter value is out of range, then the error message "+CME ERROR: operation not supported" will be provided (if +CMEE is set to 2).

5.14 Call meter maximum event +CCWE

+CCWE						
Modules	LEON-G SARA-G					
	LISA-U SARA-U					
Attributes	Syntax	PIN required	Settings saved	Can be aborted	Response time	Error reference
	full	No	No	No	-	+CME Error

5.14.1 Description

Allows sending a URC +CCWV to DTE, when enabled. The syntax of the URC is: +CCWV. The warning is issued when approximately 30 s call time remains. It is also sent when starting a call if less than 30 s call time remains.

5.14.2 Syntax

Type	Syntax	Response	Example
Set	AT+CCWE=<mode>	OK	AT+CCWE=1 OK
Read	AT+CCWE?	+CCWE: <mode> OK	+CCWE: 0 OK
Test	AT+CCWE=?	+CCWE: (list of supported <mode>s) OK	+CCWE: (0-1) OK
URC		+CCWV	

5.14.3 Defined values

Parameter	Type	Description
<mode>	Number	<ul style="list-style-type: none"> 0: disable the call meter warning event 1: enable the call meter warning event

5.15 Set greeting text +CSGT

+CSGT						
Modules	LEON-G SARA-G					
	LISA-U SARA-U					
Attributes	Syntax	PIN required	Settings saved	Can be aborted	Response time	Error reference
	partial	No	NVM	No	-	+CME Error

5.15.1 Description

Configures and activates/deactivates the greeting text. The greeting text is shown on any AT interface as soon as the DTR line is set to ON state. The command can also deactivate a text.



The greeting message setting is saved in NVM.

5.15.2 Syntax

Type	Syntax	Response	Example
Set	AT+CSGT=<mode>[,<text>]	OK	AT+CSGT=1,"Hello user" OK
Read	AT+CSGT?	+CSGT: <text>,<mode> OK	+CSGT: "Hello",0 OK
Test	AT+CSGT=?	+CSGT: (list of <mode>s),<ltext> OK	+CSGT: (0-1),49 OK

5.15.3 Defined values

Parameter	Type	Description
<text>	String	Contains the greeting text. The factory-programmed value is the empty string
<mode>	Number	<ul style="list-style-type: none"> 0: turn off greeting text 1: turn on greeting text
<ltext>	Number	Maximum length of <text>

5.15.4 Notes

LEON-G / SARA-G

- The greeting text is shown even if the DTR line is set to OFF state.

5.16 Automatic time zone update +CTZU

+CTZU						
Modules	LEON-G SARA-G					
	LISA-U SARA-U					
Attributes	Syntax	PIN required	Settings saved	Can be aborted	Response time	Error reference
	full	Yes	NVM	No	-	+CME Error

5.16.1 Description

Enables and disables automatic time zone update via NITZ.



Time Zone information is provided after network registration (if the network supports the time zone information).

5.16.2 Syntax

Type	Syntax	Response	Example
Set	AT+CTZU=<onoff>	OK	AT+CTZU=1 OK
Read	AT+CTZU?	+CTZU: <onoff> OK	+CTZU: 0 OK
Test	AT+CTZU=?	+CTZU: (list of supported <onoff>s) OK	+CTZU: (0-1) OK

5.16.3 Defined values

Parameter	Type	Description
<onoff>	Number	<ul style="list-style-type: none"> 0 (factory-programmed value): disable automatic time zone via NITZ 1: enable automatic time zone update via NITZ; if the network supports the service, the local time of the module is changed (not only time zone)

5.17 Time zone reporting +CTZR

+CTZR						
Modules	LEON-G SARA-G					
	LISA-U SARA-U					
Attributes	Syntax	PIN required	Settings saved	Can be aborted	Response time	Error reference
	partial	Yes	No	No	-	+CME Error

5.17.1 Description

Enables and disables time zone change event reporting. If reporting is enabled, the MT returns the +CTZV URC whenever the time zone changes and, in addition, the +CTZDST URC whenever daylight saving time information is available.

5.17.2 Syntax

Type	Syntax	Response	Example
Set	AT+CTZR=<onoff>	OK	AT+CTZR=1 OK
Read	AT+CTZR?	+CTZR: <onoff> OK	+CTZR: 0 OK
Test	AT+CTZR=?	+CTZR: (list of supported <onoff>s) OK	+CTZR: (0-1) OK
URC		+CTZV: <tz>,<time>	+CTZV: +04,"12/12/31,23:46:33"
URC		+CTZDST: <dst>	+CTZDST: 1

5.17.3 Defined values

Parameter	Type	Description
<onoff>	Number	<ul style="list-style-type: none"> 0: disable time zone change event reporting (default value) 1: enable time zone change event reporting
<tz>	Number	Indicates the time zone. the range goes from -48 to +56
<time>	String	Format is "yy/MM/dd,hh:mm:ss ". The characters indicate year, month, day, hour, minutes, seconds.
<dst>	Number	Indicates the daylight saving time. The allowed values are: <ul style="list-style-type: none"> 0: no adjustments 1: +1 hour adjustment 2: +2 hours adjustment

5.17.4 Notes

- The time zone reporting is not affected by the automatic time zone setting command, +CTZU.
- The time zone information is expressed in steps of 15 minutes.

LEON-G / SARA-G

- The <time> parameter is not supported.
- The Daylight saving information reporting is not supported.

5.18 Report mobile termination error +CMEE

+CMEE						
Modules	LEON-G SARA-G					
	LISA-U SARA-U					
Attributes	Syntax	PIN required	Settings saved	Can be aborted	Response time	Error reference
	full	No	No	No	-	+CME Error

5.18.1 Description

Enables or disables the use of result code +CME ERROR: <err> as an indication of an error relating to the functionality of the MT. When enabled, MT related errors cause +CME ERROR: <err> final result code instead of the regular ERROR final result code. ERROR is returned normally when error is related to syntax, invalid parameters or MT functionality.

5.18.2 Syntax

Type	Syntax	Response	Example
Set	AT+CMEE=[<n>]	OK	AT+CMEE=2 OK
Read	AT+CMEE?	+CMEE: <n> OK	+CMEE: 0 OK
Test	AT+CMEE=?	+CMEE: (list of supported <n>s) OK	+CMEE: (0-2) OK

5.18.3 Defined values

Parameter	Type	Description
<n>	Number	<ul style="list-style-type: none"> 0: disable +CME ERROR: <err> result code and use ERROR instead 1: enable +CME ERROR: <err> result code and use numeric <err> values 2: enable +CME ERROR: <err> result code and use verbose <err> values

5.18.4 Notes

- When +CMEE=2 selected, the following convention is valid:
 - If the error code is related to a parameter not covered by the GSM/ETSI or u-blox specification, the value <error>="operation not supported" shall be reported.
 - If the MT is in a state which does not allow performing the entered command, the value <error>="peration not allowed" shall be reported

6. Call control

6.1 Select type of address +CSTA

+CSTA						
Modules	LEON-G SARA-G					
	LISA-U SARA-U					
Attributes	Syntax	PIN required	Settings saved	Can be aborted	Response time	Error reference
	full	No	No	No	-	+CME Error

6.1.1 Description

Selects the type of number for further dialling commands (D) according to 3GPP specifications.



The type of address is automatically detected from the dialling string thus the +CSTA command has no effect.

6.1.2 Syntax

Type	Syntax	Response	Example
Set	AT+CSTA=[<type>]	OK	AT+CSTA=145 OK
Read	AT+CSTA?	+CSTA: <type> OK	+CSTA: 145 OK
Test	AT+CSTA=?	+CSTA: (list of supported <type>s) OK	+CSTA: (129,145) OK

6.1.3 Defined values

Parameter	Type	Description
<type>	Number	Type of address in integer format <ul style="list-style-type: none"> • 145: dialling string includes international access code character '+' • 129 (default value): national coded dialing string

6.2 Dial command D

D						
Modules	LEON-G SARA-G					
	LISA-U SARA-U					
Attributes	Syntax	PIN required	Settings saved	Can be aborted	Response time	Error reference
	full	Yes	No	Yes	Up to 3 min	+CME Error

6.2.1 Description

Lists characters that may be used in a dialling string for making a call (voice, data or fax call) or controlling supplementary services in accordance with [15] and initiates the indicated kind of call. No further commands may follow in the command line in case of data or fax calls.



If the semicolon ';' is given after the phone number, a voice call is originated, regardless of the value set via +FCLASS command; otherwise the kind of call depends on the service class previously selected via +FCLASS command.









"ATD1;" is used to call the Voice Mail number. The number is stored in the SIM card (in EF_{CPHS} or EF_{MBDN}) but the presence of both files is not mandatory. The command returns an error message if the number cannot be retrieved but also if the Voice Mail number has been disabled (see +CSVM for further details).

6.2.2 Syntax

Type	Syntax	Response	Example
Action	ATD<number>[<I>][<G>][:;]	see Chapter 6.2.5 "Responses"	(Voice Call) ATD123456; OK (Data / Fax Call) ATD123456 CONNECT 9600 (Supplementary Services) ATD*#43# +CCWA: 0,1 +CCWA: 0,2 OK

6.2.3 Defined values

Parameter	Type	Description
<number>	Number	<p>Phone number; the allowed digits are the V.25ter dialling digits 1, 2, 3, 4, 5, 6, 7, 8, 9, 0, *,#, +, A, B, C, D, P. The following digits are exceptions:</p> <ul style="list-style-type: none">  ', T, !, W and @ are accepted but ignored  P is interpreted as separator between the dialling number and a DTMF string (which can be made up by the digits 1, 2, 3, 4, 5, 6, 7, 8, 9, 0, *, #, A, B, C, P) and pause between the DTMF tones, i.e. its first occurrence is interpreted as separator and pause, the following occurrences are interpreted only as pause  A is interpreted as P due to the BCD extended coding (refer to 3GPP TS 31.102 [19] and 3GPP TS 24.008 [30])  + is valid only for the first digit  LISA-U + can be given only for the first position.
<I>	String	<p>Set the CLI status; allowed values are:</p> <ul style="list-style-type: none"> • I (ASCII code 49 Hex): restrict CLI presentation • i: allow CLI presentation <p> CLIR supplementary service subscription is overridden for this call.</p>
<G>	String	<p>Enable / disable the CUG supplementary service for the specific call</p> <ul style="list-style-type: none"> • G: activate CUG • g: deactivate CUG <p>The index and the information parameters used during the call will be the same previously set with +CCUG command.</p>
<data rate>	Number	<p>Refer to command +CBST (refer to Chapter 6.2.5 "Responses")</p> <p> In case of data/fax call, refer to "Circuit 108/2, +++ behavior for the different &D: summarizing table" (Chapter 14.3.5) to return in command mode and disconnect the call.</p>

6.2.4 Notes

LEON-G

- The syntax ATD is allowed. It is only used for service TS61 (alternate speech and G3 FAX) to trigger an in-call modification.

6.2.5 Responses

The following table lists the possible responses to the command. The response is formatted using the [V](#) command.

Verbose	Numeric	Description
OK	0	Acknowledges successful execution of the command; this response is provided only during voice calls
CONNECT	1	A connection has been established
NO CARRIER	3	The connection has been terminated from the remote part or the attempt to establish a connection failed
ERROR	4	General failure
BUSY	7	Engaged signal detected (the called number is busy)
NO ANSWER	8	If no hang up is detected after a fixed network timeout
CONNECT<data rate>	9	Same as CONNECT but includes the data rate (data call)

6.2.6 Voice Call Example

The following diagram illustrates the possible transitions in both Mobile Terminated and Mobile Originated calls. Responses and result codes generated by MT are in italic.

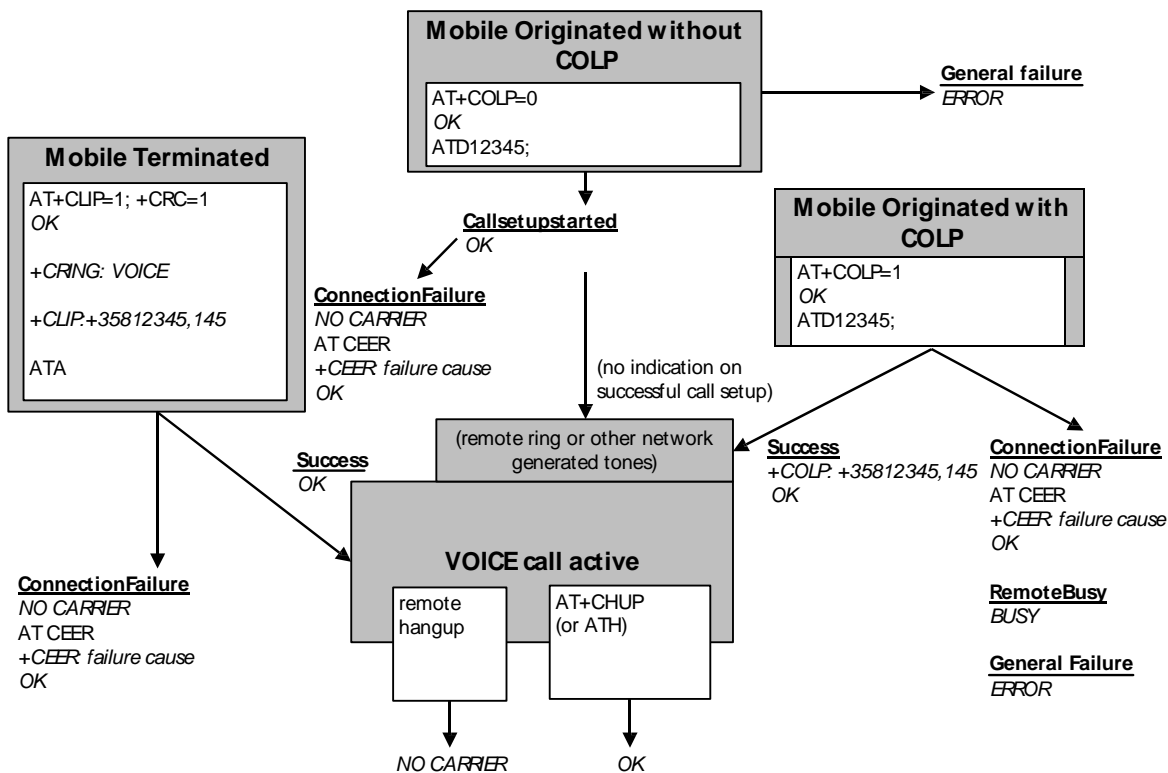

6.3 Direct calling from phonebooks D>

D>						
Modules	LEON-G SARA-G340 SARA-G350					
	LISA-U SARA-U					
Attributes	Syntax	PIN required	Settings saved	Can be aborted	Response time	Error reference
	full	No	No	No	Up to 3 min	+CME Error

6.3.1 Description

Allows voice, data or fax calls, selecting the phone number from the phonebook.



If the semicolon ';' is given after the phone number, a voice call is originated, regardless of the value set via +FCLASS command; otherwise the kind of call depends on the service class previously selected via +FCLASS command.

6.3.2 Syntax

Type	Syntax	Response	Example
Action	ATD<<str>[I][G][:]	see Chapter 6.2.5 "Responses"	ATD>"u-blox"; OK
	ATD<<mem><n>[I][G][:]	see Chapter 6.2.5 "Responses"	ATD>SM1; OK
	ATD<<n>[I][G][:]	see Chapter 6.2.5 "Responses"	ATD>1; OK

6.3.3 Defined values

Parameter	Type	Description
<str>	String	D<<str>[I][G][:] originates a call to phone number with corresponding alphanumeric field in the phonebook (set via +CPBS command; more details in Chapter 9.1) is <str>.
<mem><n>	String	D<<mem><n>[I][G][:] originates a call to phone number in memory (one of the phonebooks) <mem> entry location <n>; refer to +CPBS command (Chapter 9.1) for <mem> value.  <mem> value must be inserted without quotation marks ("")
<n>	String	D<<n>[I][G][:] originate a call to phone number in entry location <n> of the phonebook (set via +CPBS command; more details in Chapter 9.1).
[I][G][:]	String	Refer to Chapter 6.2 "Dial command D"

6.4 Select tone dialling T

T						
Modules	LEON-G SARA-G340 SARA-G350					
	LISA-U SARA-U					
Attributes	Syntax	PIN required	Settings saved	Can be aborted	Response time	Error reference
	full	No	No	No	-	+CME Error

6.4.1 Description

Causes subsequent (or previous) D command to assume that DTMF dialling is to be used. Since DTMF dialling is default in GSM, this command has no effect.

6.4.2 Syntax

Type	Syntax	Response	Example
Action	ATT	OK	

6.5 Select pulse dialling P

P						
Modules	LEON-G SARA-G340 SARA-G350					
	LISA-U SARA-U					
Attributes	Syntax	PIN required	Settings saved	Can be aborted	Response time	Error reference
	full	No	No	No	-	+CME Error

6.5.1 Description

Causes subsequent (or previous) D command to assume that pulse dialling is to be used. Since DTMF dialling is default in GSM, this command has no effect.

6.5.2 Syntax

Type	Syntax	Response	Example
Action	ATP	OK	

6.6 Call answer A

A						
Modules	LEON-G SARA-G					
	LISA-U SARA-U					
Attributes	Syntax	PIN required	Settings saved	Can be aborted	Response time	Error reference
	full	No	No	No	< 20 s	+CME Error

6.6.1 Description

Instructs the DCE to immediately connect to the line and start the answer sequence as specified for the underlying DCE. Any additional command that appears after A on the same command line is ignored. The command is abortable. The user is informed that an incoming call is waiting, by the information result code RING or +CRING: <type> (refer to [Chapter 12.10](#)) displayed on MT.

6.6.2 Syntax

Type	Syntax	Response	Example
Action	ATA	RING OK	

6.7 Hook control H

H						
Modules	LEON-G SARA-G					
	LISA-U SARA-U					
Attributes	Syntax	PIN required	Settings saved	Can be aborted	Response time	Error reference
	full	No	No	No	< 20s	-

6.7.1 Description

Disconnects the remote user. In case of multiple calls, all the active calls and held calls are released while the waiting calls are not.

 In case of dual service calls, the command will switch the call from data (if different from fax) to voice.

 If the module has a PDP context activated and is in On-Line Command Mode (OLCM), the command deactivates the context. During the PSD OLCM an incoming CS call can be accepted with an ATA command ([Chapter 6.6](#)). Subsequent ATH command releases the current CS call while leaving the PDP context activated. In this state a second ATH command also deactivates the PDP context.

- A CS data call cannot be established during PSD OLCM (CS voice call only where is supported).
- In case of multiple calls, all the active calls are released while the waiting and held calls are not.

6.7.2 Syntax

Type	Syntax	Response	Example
Action	ATH	OK	

6.8 Monitor speaker loudness L

L						
Modules	LEON-G SARA-G340 SARA-G350					
	LISA-U SARA-U					
Attributes	Syntax	PIN required	Settings saved	Can be aborted	Response time	Error reference
	full	No	No	No	-	+CME Error

6.8.1 Description

This command has no effect. It is implemented for compatibility with ITU-T V.25ter recommendation [\[21\]](#).

6.8.2 Syntax

Type	Syntax	Response	Example
Action	ATL[<value>]	OK	ATL0 OK

6.8.3 Defined values

Parameter	Type	Description
<value>	Number	0-3

6.9 Monitor speaker mode M

M						
Modules	LEON-G SARA-G340 SARA-G350 LISA-U SARA-U					
Attributes	Syntax	PIN required	Settings saved	Can be aborted	Response time	Error reference
	full	No	No	No	-	+CME Error

6.9.1 Description

This command has no effect. It is implemented for compatibility with ITU-T V.25ter recommendation [21].

6.9.2 Syntax

Type	Syntax	Response	Example
Action	ATM<value>	OK	ATM0 OK

6.9.3 Defined values

Parameter	Type	Description
<value>	Number	0-2

6.10 Call mode +CMOD

+CMOD						
Modules	LEON-G SARA-G LISA-U SARA-U					
Attributes	Syntax	PIN required	Settings saved	Can be aborted	Response time	Error reference
	full	No	No	No	-	+CME Error

6.10.1 Description

Selects the call mode of further dialing commands (D) or for next answering command (A).

6.10.2 Syntax

Type	Syntax	Response	Example
Set	AT+CMOD=<mode>	OK	AT+CMOD=0 OK
Read	AT+CMOD?	+CMOD: <mode> OK	+CMOD: 0 OK
Test	AT+CMOD=?	+CMOD: (list of supported <mode>s) OK	+CMOD: (0-1) OK

6.10.3 Defined values

Parameter	Type	Description
<mode>	Number	<ul style="list-style-type: none"> 0: single mode

Parameter	Type	Description
		<ul style="list-style-type: none"> 1: TS61 (voice alternating with fax) (TS means Tele Service)

6.10.4 Notes

- <mode>=1 is only available on modules where the fax is available.

6.11 Hang up call +CHUP

+CHUP						
Modules	LEON-G SARA-G					
	LISA-U SARA-U					
Attributes	Syntax	PIN required	Settings saved	Can be aborted	Response time	Error reference
	full	No	No	No	< 20 s	+CME Error

6.11.1 Description

Causes the MT to hang up the current GSM or UMTS call.



In case of multiple calls, all active calls will be released, while waiting and held calls are not.



The command does not replace the ITU-T V.250 [20] command H, but gives an assured procedure to terminate an alternating mode call. For further information see the 3GPP TS 27.007 [2].

6.11.2 Syntax

Type	Syntax	Response	Example
Action	AT+CHUP	OK	AT+CHUP OK
Test	AT+CHUP=?	OK	AT+CHUP=? OK

6.12 Single numbering scheme +CSNS

+CSNS						
Modules	LEON-G SARA-G					
	LISA-U SARA-U					
Attributes	Syntax	PIN required	Settings saved	Can be aborted	Response time	Error reference
	partial	No	No	No	-	+CME Error

6.12.1 Description

Selects the bearer service to be used when a mobile terminated single numbering scheme call is established, i.e. when a call without bearer capability information element is received. Refer to 3GPP TS 23.972 - Circuit switched multimedia telephony [62]. Parameter values set with +CBST command shall be used when <mode> equals to a data service.

The behavior of this command depends on the network service.

Test command returns values supported as compound values.



Before setting +CSNS to 4 (data), the bearer capability to be sent to the network must be defined with AT+CBST command (e.g. AT+CBST=0,0,1) (refer to [Chapter 12.2](#)).

6.12.2 Syntax

Type	Syntax	Response	Example
Set	AT+CSNS=<mode>	OK	AT+CSNS=0 OK
Read	AT+CSNS?	+CSNS: <mode>	+CSNS: 0



Type	Syntax	Response	Example
		OK	OK
Test	AT+CSNS=?	+CSNS: (list of supported <mode>s) OK	+CSNS: (0,4) OK

6.12.3 Defined values

Parameter	Type	Description
<mode>	Number	<ul style="list-style-type: none"> 0: voice 2: fax (TS 62; TS means Tele Service) 4: data

6.12.4 Notes

- <mode>=0 is only supported by modules where the voice is available.
- <mode>=2 is only supported by modules where the fax is available.

6.13 Set reporting call status +UCALLSTAT

+UCALLSTAT						
Modules	LEON-G SARA-G LISA-U SARA-U					
Attributes	Syntax	PIN required	Settings saved	Can be aborted	Response time	Error reference
	full	No	No	No	-	+CME Error

6.13.1 Description

Allows to enable / disable the reporting voice or data call status on the DTE using the URC +UCALLSTAT. This URC is generated each time a call status change occurs. When multiple calls change status at the same time (e.g. when all multiparty calls are terminated) a URC +UCALLSTAT is generated for each of them.

6.13.2 Syntax

Type	Syntax	Response	Example
Set	AT+UCALLSTAT=<enable>	OK	AT+UCALLSTAT=1 OK
Read	AT+UCALLSTAT?	+UCALLSTAT: <enable> OK	+UCALLSTAT: 1 OK
Test	AT+UCALLSTAT=?	+UCALLSTAT: (list of supported <enable>'s) OK	+UCALLSTAT: (0-1) OK
URC		+UCALLSTAT: <call_id>,<stat>	+UCALLSTAT: 1,2

6.13.3 Defined values

Parameter	Type	Description
<enable>	Number	<ul style="list-style-type: none"> 0: reporting disabled 1: reporting enabled
<call_id>	Number	Indicates the call identification (refer to 3GPP TS 22.030 [15])
<stat>	Number	Indicates the call status <ul style="list-style-type: none"> 0: active 1: hold 2: dialling (Mobile Originated call) 3: alerting (Mobile Originated call; ringing for the remote party) 4: ringing (Mobile Terminated call) 5: waiting (Mobile Terminated call) 6: disconnected



Parameter	Type	Description
		<ul style="list-style-type: none"> 7: connected (indicates the completion of a call setup first time for MT and MO calls - this is reported in addition to state active)

6.13.4 Notes

- The URC is displayed on the terminal where the command has been issued. For the USB terminals, the <enable> flag is reset when the USB cable is disconnected.

6.14 Information to in-band-tones availability +UPROGRESS

+UPROGRESS						
Modules	LISA-U SARA-U					
Attributes	Syntax	PIN required	Settings saved	Can be aborted	Response time	Error reference
	full	No	No	No	-	+CME Error

6.14.1 Description

Enables or disables the display of URC +UPROGRESS: <cin>,<status> on the DTE while a call is in progress.

6.14.2 Syntax

Type	Syntax	Response	Example
Set	AT+UPROGRESS=<mode>	OK	AT+UPROGRESS=1 OK
Read	AT+UPROGRESS?	+UPROGRESS: <mode> OK	+UPROGRESS: 1 OK
Test	AT+UPROGRESS=?	+UPROGRESS: (list of the supported <mode>s) OK	+UPROGRESS: (0,1) OK
URC		+UPROGRESS: <cin>,<status> OK	+UPROGRESS: 1,7

6.14.3 Defined values

Parameter	Type	Description
<mode>	Number	Enabling the URC +UPROGRESS <ul style="list-style-type: none"> 0: disable unsolicited result code +UPROGRESS 1: enable unsolicited result code +UPROGRESS
<cin>	String	Call number indication
<status>	Number	Indicates the call progress status <ul style="list-style-type: none"> 0: no progress 1: alerting, in-band tones or TCH not yet available 2: mobile terminated call now accepted, TCH yet available 3: in-band tones available 4: in-band tones not available 5: TCH now available, mobile terminated call accepted 6: TCH now available, in-band tones available 7: TCH now available, in-band tones not available 8: TCH changed from data to speech 9: TCH changed from speech to data 10: TCH changed to signalling or data 11: the last speech call has been terminated and the speech can be disabled. Mute uplink, downlink and disable speech 12: Fast connection is available 13: Fast connection is closed 14: progress information element playing announcement has been received

6.15 Tone duration +VTD

+VTD						
Modules	LEON-G SARA-G340 SARA-G350 LISA-U120 LISA-U130 LISA-U200-01S LISA-U200-02S LISA-U200-52S LISA-U200-62S LISA-U200-82S LISA-U230 LISA-U260 LISA-U270 SARA-U					
Attributes	Syntax	PIN required	Settings saved	Can be aborted	Response time	Error reference
	full	No	No	No	-	+CME Error

6.15.1 Description

Refers to an integer <n> that defines the length of tones emitted as a result of the +VTS command.



The effective maximum DTMF tone duration is network dependent, i.e. the receiver can experience a shorter tone duration than the one specified with +VTD (or with +VTS).

6.15.2 Syntax

Type	Syntax	Response	Example
Set	AT+VTD=[<n>]	OK	AT+VTD=2 OK
Read	AT+VTD?	+VTD: <n> OK	+VTD: 1 OK
Test	AT+VTD=?	+VTD: (list of supported <n>s) OK	+VTD: (0-255) OK

6.15.3 Defined values

Parameter	Type	Description
<n>	Number	Range is from 0 to 255. The value 1 is default. A value different than zero causes a tone of duration <n>/10 seconds (<n> * 0.1 s). If the value 0 is selected, the tone duration is set to the default value.

6.16 DTMF and tone generation +VTS

+VTS						
Modules	LEON-G SARA-G340 SARA-G350 LISA-U120 LISA-U130 LISA-U200-01S LISA-U200-02S LISA-U200-52S LISA-U200-62S LISA-U200-82S LISA-U230 LISA-U260 LISA-U270 SARA-U					
Attributes	Syntax	PIN required	Settings saved	Can be aborted	Response time	Error reference
	full	Yes	No	Yes	Up to 7 min	+CME Error

6.16.1 Description

Allows the transmission of DTMF tones. These tones may be used e.g. when announcing the start of a recording period. The command can only be used during an active voice call. The command is abortable if a character is sent to DCE during the command execution, and it is not covered by the 3GPP specification.



The actual maximum DTMF tone duration is network dependent, i.e. the receiver can experience a shorter tone duration than the one specified with +VTS (or with +VTD).



The tone duration is network dependent; hence the value set with +VTS command is only the "desired" duration. For more information refer to 3GPP TS 23.014 [78].

6.16.2 Syntax

Type	Syntax	Response	Example
Set	AT+VTS=<DTMF>[,<duration>]	OK	AT+VTS=2 OK or

Type	Syntax	Response	Example
			AT+VTS=2A,10 OK
Test	AT+VTS=?	+VTS: (list of <DTMF>s),(list of supported <duration>s) OK	+VTS: (0-9,#,*,A-D),(0-255) OK

6.16.3 Defined values

Parameter	Type	Description
<DTMF>	Character	String (without quotation marks) of ASCII characters from the set 0-9, #, *, A-D.
<duration>	Number	Range 0-255, expressed in <duration>/100 seconds (0.01 s). If left out or set to 0, the tone duration is given by the +VTD setting

6.16.4 Notes

- If the command is invoked when not in a call, an error is reported ("CME ERROR: no connection to phone" if +CMEE is set to 2).

6.17 Start and stop tone generation +UVTS

+UVTS						
Modules	LISA-U120 LISA-U130 LISA-U2 SARA-U					
Attributes	Syntax	PIN required	Settings saved	Can be aborted	Response time	Error reference
	full	No	No	No	-	+CME Error

6.17.1 Description

Starts and stops the DTMF tones. In GSM this operates only in voice mode.



For more information refer to 3GPP TS 23.014 [78].



When <DTMF> parameter is omitted the tone is stopped.

6.17.2 Syntax

Type	Syntax	Response	Example
Set	AT+UVTS=[<DTMF>]	OK	AT+UVTS=2 OK
Test	AT+UVTS=?	+UVTS: (list of <DTMF>s) OK	+UVTS: (0-9,#,*,A-D) OK

6.17.3 Defined values

Parameter	Type	Description
<DTMF>	Char	Single ASCII character in the set 0-9, #, *, A-D

6.17.4 Notes

- If the command is invoked when not in a call, an error is reported ("CME ERROR: no connection to phone" if +CMEE set to 2).

6.18 Redial last telephone number DL

DL						
Modules	LEON-G SARA-G340 SARA-G350					
	LISA-U SARA-U					
Attributes	Syntax	PIN required	Settings saved	Can be aborted	Response time	Error reference
	full	Yes	No	No	<i>Up to 3 min</i>	<i>+CME Error</i>

6.18.1 Description

Redials the last number used in the ATD command. This command can be aborted. The command redials the last called number as a data call, while the ATDL; command redials the last called number as a voice call, regardless of whether the number was previously dialled as data or voice call. The last called number is stored locally in volatile memory.

6.18.2 Syntax

Type	Syntax	Response	Example
Action	ATDL[:]	see Chapter 6.2.5 "Responses"	ATDL OK

6.18.3 Notes

LEON-G / SARA-G340 / SARA-G350

- Both "ATDL" and "ATDL;" commands redial the last called number as voice call, regardless if the number was previously dialled as data or voice call. The last called number is stored in the SIM card's last-dialling phonebook.

6.19 Automatic answer S0

S0						
Modules	LEON-G SARA-G					
	LISA-U SARA-U					
Attributes	Syntax	PIN required	Settings saved	Can be aborted	Response time	Error reference
	partial	No	<i>Profile</i>	No	-	<i>+CME Error</i>

6.19.1 Description

Controls the automatic answering feature of the DCE. If set to 0, the automatic answering is disabled, otherwise it causes the DCE to answer when the incoming call indication (RING) has occurred the number of times indicated by the value.



For an incoming CSD call, if the autoanswering is enabled and the <value> parameter of &D command (refer to [Chapter 14.3](#) for the command description) is set to 2, the autoanswering only works if the DTR line of the AT interface with activated autoanswering is set to ON. Otherwise, if DTR is OFF, then the call is rejected. If the <value> parameter of &D command is not set to 2, the DTR state has no impact on autoanswering.

6.19.2 Syntax

Type	Syntax	Response	Example
Set	ATS0=<value>	OK	ATS0=2 OK
Read	ATS0?	<value> OK	000 OK

6.19.3 Defined values

Parameter	Type	Description
<value>	Number	Value in the range 0-255; the answer to the read command is in "xxx" format. <ul style="list-style-type: none"> • 0: disables automatic answer mode • 1-255: Enables automatic answering after specified number of rings • The factory-programmed value is 0

6.19.4 Notes

LEON-G / SARA-G

- The <value> parameter is not mandatory, the default value is 0.

6.20 Set voice mail number +CSVM

+CSVM						
Modules	LISA-U SARA-U					
Attributes	Syntax	PIN required	Settings saved	Can be aborted	Response time	Error reference
	full	No	No	No	< 20s	+CME Error

6.20.1 Description

Sets the phone number of the voice mail server.



If the parameter <mode> is set to 0, the remaining parameters are ignored.



The voice number is stored in EF_{CPHS} or EF_{MBDN}. Their presence on the SIM card is not mandatory. If neither are present, then the set and read command returns an error message.



To call the voice mail number (if possible), use the *ATDI;* command.

6.20.2 Syntax

Type	Syntax	Response	Example
Set	AT+CSVM=<mode>[,<number>[,<type>]]	OK	AT+CSVM=1,"+1234567890",145 OK
Read	AT+CSVM?	+CSVM: <mode>,<number>,<type> OK	+CSVM: 0,"+1234567890",145 OK
Test	AT+CSVM=?	+CSVM: (list of supported <mode>s),(list of supported <type>s) OK	+CSVM: (0-1),(128-255) OK

6.20.3 Defined values

Parameter	Type	Description
<mode>	Number	<ul style="list-style-type: none"> • 0: voice mail number disabled • 1: voice mail number enabled
<number>	String	Phone number; see the <i>D</i> command description
<type>	Number	Type of address, octet in Number format <ul style="list-style-type: none"> • 145: <number> string includes '+' • 129: otherwise

6.20.4 Notes

- The <number> and <type> parameters can be left out if the parameter <mode> is set to 0.

7. Network service

7.1 Subscriber number +CNUM

+CNUM						
Modules	LEON-G SARA-G340 SARA-G350 LISA-U SARA-U					
Attributes	Syntax	PIN required	Settings saved	Can be aborted	Response time	Error reference
	full	Yes	No	No	< 10 s	+CME Error

7.1.1 Description

Returns the MSISDNs related to this subscriber. If the subscriber has different MSISDN for different services, each MSISDN is returned in a separate line.

 MSISDN is read from the SIM.

7.1.2 Syntax

Type	Syntax	Response	Example
Action	AT+CNUM	+CNUM: [<alpha1>],<number1>,<type1> [+CNUM: [<alpha2>],<number2>,<type2> [...]] OK or OK	+CNUM: "Mario Rossi","+39320821708",145 +CNUM: "ABCD . AAA","123456789012",129 OK
Test	AT+CNUM=?	OK	

7.1.3 Defined values

Parameter	Type	Description
<alphax>	String	Associated with <numberx>; used character set is selected by setting +CSCS (refer to Chapter 4.10)
<numberx>	String	Phone number of format specified by <typex>
<typex>	Number	Type of address, octet in Number format (145 when <numberx> string includes '+', otherwise 129)

7.2 Signal quality +CSQ

+CSQ						
Modules	LEON-G SARA-G LISA-U SARA-U					
Attributes	Syntax	PIN required	Settings saved	Can be aborted	Response time	Error reference
	full	No	No	No	-	+CME Error

7.2.1 Description

Returns the signal strength indication <rssi> and <qual> from the MT. The radio signal strength <rssi> will be also used to build and display the indicator "signal" i.e. signal quality in the response code +CIND (refer to [Chapter 5.4](#)) and in the URC +CIEV (refer to [Chapter 5.6](#)).

In dedicated mode, during radio channel reconfiguration (e.g. handover), invalid measurements may be returned for a short transitory because the MT has to compute them on the newly assigned channel.



7.2.2 Syntax

Type	Syntax	Response	Example
Action	AT+CSQ	+CSQ: <rssi>,<qual> OK	+CSQ: 2,5 OK
Test	AT+CSQ=?	+CSQ: (list of supported <rssi>s),(list of supported <qual>s) OK	+CSQ: (0-31,99),(0-7,99) OK

7.2.3 Defined values

Parameter	Type	Description
<rssi>	Number	Received Signal Strength Indication - In 2G RAT it remaps the RXLEV of the serving cell or the RXLEV of the GSM dedicated channel, if any (see <RxLev> in Chapter 7.19). In UMTS RAT it remaps the RSCP (Received Signal Code Power) of the current cell (see <rscp_lev> in Chapter 7.19). For both RATs the range is the following: <ul style="list-style-type: none"> 0: -113dBm or less 1: -111 dBm 2..30: from -109 to -53 dBm with 2 dBm steps 31: -51 dBm or greater 99: not known or not detectable or currently not available
<qual>	Number	In 2G RAT indicates the BER (Bit Error Rate). This value is updated only in CS dedicated mode. <ul style="list-style-type: none"> 0..7: as RXQUAL values as described in GSM TS 05.08 [28] 99: not known or not detectable In UMTS RAT indicates the Energy per Chip/Noise ratio in dB levels of the current cell (see <ecn0_lev> in Chapter 7.19) mapped as follows: <ul style="list-style-type: none"> 0: values from 49 to 44 1: values from 43 to 38 2: values from 37 to 32 3: values from 31 to 26 4: values from 25 to 20 5: values from 19 to 14 6: values from 13 to 8 7: values from 7 to 0 99: not known or not detectable or currently not available

7.2.4 Notes

- On LEON-G100-07S and LEON-G100-08S versions, the Received Signal Strength Indication and the <qual> parameters are also updated in GPRS packet transfer mode as described in 3GPP TS 05.08 [\[28\]](#).

7.3 Operator selection +COPS

+COPS						
Modules	LEON-G SARA-G LISA-U SARA-U					
Attributes	Syntax	PIN required	Settings saved	Can be aborted	Response time	Error reference
	partial	No	Profile	Yes	Up to 3 min	+CME Error

7.3.1 Description

Forces an attempt to select and register with the network operator. Through <mode> parameter the network selection can automatically be performed or forced by this command: the access technology is indicated in <AcT> parameter (where supported).

u-blox cellular modules are certified according to all the capabilities and options stated in the Protocol Implementation Conformance Statement document (PICS) of the module. The PICS, according to 3GPP TS 51.010-2 [\[83\]](#) and 3GPP TS 34.121-2 [\[84\]](#), is a statement of the implemented and supported capabilities and options of a device. If the user changes the command settings about the automatic network attach during the



certification process, the PICS of the application device integrating a u-blox cellular module must be changed accordingly.

The command is accessible also without an inserted SIM. In this case the command AT+COPS=0 always returns ERROR because the network registration cannot be performed without the SIM, while the configuration (i.e. automatic registration) is correctly set. The set value can be checked with the command AT+COPS? or checking the active profile with AT+V(parameter <format> is then also visible).

 The application/user should not rely on the set command response "OK" as a confirmation that the network selection has been performed. To determine the network registration status, rely on the URC +CREG.

7.3.2 Syntax

Type	Syntax	Response	Example
Set	AT+COPS=[<mode>[,<format>[,<oper>[,<AcT>]]]]	If <mode>=0, 1, 2, 3, 4: OK	AT+COPS=0,0 OK
		If <mode>=5 and on GSM networks: [MCC:<MCC>, MNC:<MNC>, LAC:<LAC>, CI:<CI>, BSIC:<BSIC>, Arfcn:<Arfcn>, RxLev:<RxLev> [MCC:<MCC>, MNC:<MNC>, LAC:<LAC>, CI:<CI>, BSIC:<BSIC>, Arfcn:<Arfcn>, RxLev:<RxLev> [...]] OK	AT+COPS=5 MCC:222, MNC: 88, LAC:55fa, CI:ffff, BSIC:3f, Arfcn:00104, RxLev:037 MCC:222, MNC: 10, LAC:4e54, CI:ffff, BSIC:32, Arfcn:00080, RxLev:032 MCC:222, MNC: 88, LAC:55fa, CI:1d39, BSIC:3d, Arfcn:00756, RxLev:005 OK
		If <mode>=5 and on UMTS networks: [MCC:<MCC>, MNC:<MNC>, LAC:<LAC>, RAC:<RAC>, CI:<CI>, DLF:<dl_frequency>, ULF:<ul_ frequency>, SC:<SC>, RSCP LEV:<RSCP LEV>, ECN0 LEV:<ecn0_lev> [MCC:<MCC>, MNC:<MNC>, LAC:<LAC>, RAC:<RAC>, CI:<CI>, DLF:<dl_frequency>, ULF:<ul_ frequency>, SC:<SC>, RSCP LEV:<rscp_ lev>, ECN0 LEV:<ecn0_lev> [...]] OK	AT+COPS=5 MCC:222, MNC:10, LAC:61ef, RAC:14, CI:07d2088, DLF:10788, ULF: 9838, SC:81, RSCP LEV:23, ECN0 LEV:41 MCC:222, MNC:10, LAC:61ef, RAC:14, CI:07d2085, DLF:10813, ULF: 9863, SC:81, RSCP LEV:26, ECN0 LEV:41 MCC:222, MNC:01, LAC:ef8d, RAC:0 , CI:52d36fb, DLF:10688, ULF: 9738, SC:285, RSCP LEV:16, ECN0 LEV:32 OK
		If <mode>=6 and on GSM networks: [<AcT>,<MCC>,<MNC>,<LAC>,<CI>, <BSIC>,<Arfcn>,<RxLev> [<AcT>,<MCC>,<MNC>,<LAC>,<CI>, <BSIC>,<Arfcn>,<RxLev> [...]] OK	AT+COPS=6 0,222,88,55fa,ffff,3f,00104,037 ... 0,222,10,4e54,ffff,32,00080,032 ... OK
		If <mode>=6 and on UMTS networks: [<AcT>,<MCC>,<MNC>,<LAC>,<RAC>, <CI>,<dl_frequency>,<ul_frequency>, <SC>,<RSCP LEV>,<ecn0_lev> [<AcT>,<MCC>,<MNC>,<LAC>,<RAC>, <CI>,<dl_frequency>,<ul_frequency>, <SC>,<RSCP LEV>,<ecn0_lev> [...]] OK	AT+COPS=6 0,222,99,754f,2,03554d7,10713,9763, 341,255,14 ... 0,222,01,ef8d,0,52d2647,10663,9713, 453,4,23 ... OK



Type	Syntax	Response	Example
Read	AT+COPS?	OK +COPS: <mode>[,<format>,<oper>[,<AcT>]]	+COPS: 0,0,"vodafone IT" OK
Test	AT+COPS=?	OK +COPS: [(<stat>, long <oper>, short <oper>, numeric <oper>[,<AcT>])[(<stat>, long <oper>, short <oper>, numeric <oper>[,<AcT>]),[...]],(list of supported <mode>s),(list of supported <format>s)	+COPS: (2,"vodafone IT","voda IT", "22210"),(1,"SI vodafone","vodafone SI","29340"),(1,"I WIND","I WIND", "22288"),(1,"I TIM","TIM","22201"),(1,"MOBITEL","MOBITEL","29341"),,(0-4), (0-2) OK

7.3.3 Defined values

Parameter	Type	Description
<mode>	Number	Is used to chose whether the network selection is automatically done by the MT or is forced by this command to the operator <oper> given in the format <format>: <ul style="list-style-type: none"> • 0 (default value and factory-programmed value): automatic (<oper> field is ignored) • 1: manual • 2: deregister from network • 3: set only <format> • 4: manual/automatic • 5: extended network search • 6: extended network search without the tags (e.g. MCC, RxLev will not be printed, see the syntax and the command example)
<format>	Number	<ul style="list-style-type: none"> • 0 (factory-programmed value): long alphanumeric <oper> • 1: short format alphanumeric <oper> • 2: numeric <oper>
<oper>	String	Given in format <format>; this field may be up to 16 characters long for long alphanumeric format, up to 8 characters for short alphanumeric format and 5 or 6 characters long for numeric format (MCC/MNC codes). The factory-programmed value is FFFF (undefined).
<stat>	Number	<ul style="list-style-type: none"> • 0: unknown • 1: available • 2: current • 3: forbidden
<AcT>	Number	Indicates the radio access technology <ul style="list-style-type: none"> • 0: GSM • 2: UTRAN

7.3.4 Notes

- <format> and <oper> parameters are optional only if the value of <mode> parameter is 0, 2 or 3.
- If the antenna is not connected, then the response to the test command is: +COPS: ,(0-4),(0-2)
- If the set command with <mode>=0 is issued, a further set command with <mode>=0 is managed as a user reselection (refer to 3GPP TS 23.122 [70]), i.e. the module triggers a search for the HPLMN or a higher order PLMN. This is useful when roaming in areas where the HPLMN or a higher order PLMN is available. If no HPLMN or higher order PLMN is found, the module remains in the state it was in prior to the search (e.g. camped and/or registered on the PLMN before the search).
- The AT command settings for <mode>=0 and <mode>=1 are immediately stored in the current activated profile. If the MT is set in automatic selection mode (<mode>= 0), only the mode will be saved. If the MT is set in manual mode (<mode>= 1), both mode and operator will be stored in the profile.
- If <mode>=4 the module starts a manual selection of the specified operator; if this operation is not successful, the module will start an automatic network selection and will remain in automatic mode.
- If <mode>=5 or 6 is set, an extended network search is performed:
 - o **For GSM networks:** the BCCH frequencies are reported except the BCCH frequencies belonging to the BA list of the serving cell will not be reported (reported in [AT+CGED](#) command if <mode> is set



to 5 or 6). The command response includes the following data: MCC, MNC, LAC, CI, BSIC, Arfcn, RxLev (see the **+CGED** command for the parameter description)

- o **For UMTS networks:** all cells found will be reported, including those belonging to the neighbour list of the serving cell. For each cell, the scan will trigger the additional reception of the SIB type 1 and type 3, to properly report the LAC, RAC, and CI of the cell. The command response includes the following data: MCC, MNC, LAC, RAC, CI, DLF, ULF, SC, RSCP LEV, ECN0 LEV (see the **+CGED** command for the parameter description)
- The command can be aborted if a character is sent to DCE during the command execution. When aborted, the answer is "ABORTED".

LISA-U / SARA-U

- When <format> is set to alphanumeric (0 or 1) the read command's <oper> value is retrieved from the first match found in the following "name sources" (from highest to lowest priority):
 - o EF_{OPL} and EF_{PNN} files (SIM card dependent, see below)
 - o NITZ service (network dependant)
 - o CPHS operator name string (SIM card dependent)
 - o Hardcoded list in the module's firmware
- If no match is found in the "name sources" the broadcasted MCC-MNC is displayed. If the PLMN network name and operator name list services are "enabled" in the SIM card, then the EF_{OPL} and EF_{PNN} are used for displaying the <oper> name if a match can be found.
- The <mode> parameter cannot be set to 6.

LEON-G / SARA-G

- The AT command settings are not automatically stored in the current activated profile.
- When the command is aborted during the execution the answer is "OK".
- The <Act> parameter is not available.
- Supporting <mode>=5 the following restrictions apply:
 - o if the SIM card is inserted and PIN verification is enabled but has not been verified, <mode>=5 cannot be used.
 - o if the SIM card is not inserted, <mode>=5 cannot be immediately used after a switch on. Before issuing the command, the RF circuits must be enabled, e.g. by starting an emergency call or entering AT+COPS=0.
- If the cellular module boots with <mode>=2 it is not possible to start a network scan (with AT+COPS=? or AT+COPS=5 or AT+COPS=6) until AT+COPS is invoked with <mode>=0 or 1.

LEON-G100-06S

- The <mode> parameter cannot be set to 6.

SARA-G

- The <mode> parameter cannot be set to 6.

7.4 Radio Access technology selection +URAT

+URAT						
Modules	LISA-U SARA-U					
Attributes	Syntax	PIN required	Settings saved	Can be aborted	Response time	Error reference
	full	No	<i>NVM</i>	No	-	-

7.4.1 Description

Forces the selection of the Radio Access Technology (RAT) in the protocol stack. On the subsequent network registration (+COPS, +CGATT) the selected RAT is used.



u-blox cellular modules are certified according to all the capabilities and options stated in the Protocol Implementation Conformance Statement document (PICS) of the module. The PICS, according to 3GPP TS 51.010-2 [83] and 3GPP TS 34.121-2 [84], is a statement of the implemented and supported



capabilities and options of a device. If the user changes the command settings during the certification process, the PICS of the application device integrating a u-blox cellular module must be changed accordingly.

 If GSM / UTRAN (dual mode) is selected, it is also possible to select the preferred RAT, which determines which RAT is selected first (if both available).

 In Dual Mode both the GSM and UMTS Access Stratum are active and the full InterRAT measurements and handovers are provided.

7.4.2 Syntax

Type	Syntax	Response	Example
Set	AT+URAT=<AcT>[,<PreferredAct>]	OK	AT+URAT=1,0 OK
Read	AT+URAT?	+URAT: <AcT>[,<PreferredAct>] OK	
Test	AT+URAT=?	+URAT: (list of the supported <AcT>s), (list of the supported <PreferredAct>s) OK	+URAT: (0-2),(0,2) OK

7.4.3 Defined values

Parameter	Type	Description
<AcT>	Number	Indicates the radio access technology and may be: <ul style="list-style-type: none"> • 0: GSM (single mode) • 1 (factory-programmed setting): GSM / UTRAN (dual mode) • 2: UTRAN (single mode)
<PreferredAct>	Number	This parameter indicates the preferred access technology; it is ignored if dual mode (<AcT>=1) is not selected. <ul style="list-style-type: none"> • 0: GSM • 2 (default value and factory-programmed setting): UTRAN

7.4.4 Notes

- The command settings are stored in the non volatile memory.
- Any change in the RAT selection must be done in the detached state!

7.5 Display EONS names +UEONS

+UEONS						
Modules	LEON-G SARA-G					
	LISA-U SARA-U					
Attributes	Syntax	PIN required	Settings saved	Can be aborted	Response time	Error reference
	full	Yes	No	No	< 40 s	+CME Error

7.5.1 Description

This command displays the list of available networks adding EONS names if available. The list of available networks with details like long operator name, short operator name, MCC/MNC, Long EONS name, Short EONS name for each PLMN is reported. This command is an extension of AT+COPS=? command and it provides additionally EONS names for the available PLMN's.

7.5.2 Syntax

Type	Syntax	Response	Example
Action	AT+UEONS	+UEONS: [list of supported (<stat>,long alphanumeric <oper>,short alphanumeric <oper>,numeric <oper>[,<AcT>],	+UEONS: (2,"T-Mobile D","T-Mobile D", "26201","T-Mob D"," T-Mobile De"), (3, "Vodafone.de", "Vodafone.de",

Type	Syntax	Response	Example
		[EONS long operator name],[EONS short operator name]s] OK	"26202", "test network EONS", "test EONS"), (3,"E-Plus","E-Plus","26203"), (3,"o2 - de","o2 - de","26207") OK
Test	AT+UEONS=?	OK	

7.5.3 Defined values

Refer to the description of +COPS parameters (more details in [Chapter 7.3](#)).

7.5.4 Notes

LEON-G / SARA-G

- the <AcT> parameter is not supported.

7.6 Display operator name +UDOPN

+UDOPN						
Modules	LEON-G SARA-G LISA-U SARA-U					
Attributes	Syntax	PIN required	Settings saved	Can be aborted	Response time	Error reference
	partial	Yes	No	No	<i>Up to 1 s</i>	<i>+CME Error</i>

7.6.1 Description

Displays the name of the network of the requested <type>:

- If the requested information is not available (e.g. no SIM-files EF_{OPL} and EF_{PNN}), the command displays the network name which is most similar to the requested <type>
- If the requested name is the Service Provider Name (<type>= 7), a null string is displayed if not available
- In case EONS names are not available, NITZ names are displayed, if any
- In case no NITZ name is available, CPHS names are used
- In case no CPHS name is available, ROM PLMN names are displayed
- In case no ROM PLMN name matches to the current network, its numeric format (i.e. <type> 0) is returned



The maximum expected response time could request about 1 s if the data are read by the SIM.

7.6.2 Syntax

Type	Syntax	Response	Example
Set	AT+UDOPN=<type>	+UDOPN: <type>[,<name>[,<display_ condition>]] OK	AT+UDOPN=4 +UDOPN: 4,"Main Network" OK AT+UDOPN=7 +UDOPN: 7,"SERVICE-PROVIDER",1 OK AT+UDOPN=7 +UDOPN: 7,"" OK
Test	AT+UDOPN=?	+UDOPN: (list of supported <type>s) OK	+UDOPN: (0-9) OK

7.6.3 Defined values

Parameter	Type	Description
<type>	Number	<ul style="list-style-type: none"> 0: numeric format of MCC/MNC network (three BCD digit country code and two/three BCD digit network code)



Parameter	Type	Description
		<ul style="list-style-type: none"> 1: short name in ROM 2: long name in ROM 3: short network operator name (CPHS) 4: long network operator name (CPHS) 5: short NITZ name 6: full NITZ name 7: service provider name 8: EONS short operator name 9: EONS long operator name 11: short network operator name 12: long network operator name
<name>	String	<ul style="list-style-type: none"> MCC/MNC code for <type> = 0 Corresponding network name for <type> = 1, 2, 3, 4, 5, 6, 8, 9, 11 or 12 Service provider name followed by <display_condition> for <type>=7
<display_condition>	Number	Display condition as stored on SIM for the service provider name in respect to the registered PLMN (see GSM TS 11.11 [18] for more details).

7.6.4 Notes

- EONS means Enhanced Operator Name from SIM-files EF_{OPL} and EF_{PNN}.
- The coding of <name> is according to the +CSCS setting.

LEON-G / SARA-G

- <type>=11 and <type>=12 are not supported.

7.7 Preferred PLMN list selection +CPLS

+CPLS						
Modules	LISA-U SARA-U					
Attributes	Syntax	PIN required	Settings saved	Can be aborted	Response time	Error reference
	full	No	No	No	-	+CME Error

7.7.1 Description

Selects one PLMN selector with Access Technology list in the SIM card or active application in the UICC (GSM or USIM), that is used by +CPOL command.

The set command selects a list in the SIM/USIM. The read command returns the selected PLMN selector list from the SIM/USIM.

The test command returns the whole index range supported lists by the SIM/USIM.

7.7.2 Syntax

Type	Syntax	Response	Example
Set	AT+CPLS=[<list>]	OK	
Read	AT+CPLS?	+CPLS: <list> OK	+CPLS: 1 OK
Test	AT+CPLS=?	+CPLS: (list of supported <list>s) OK	+CPLS: (0-2) OK

7.7.3 Defined values

Parameter	Type	Description
<list>	Number	<ul style="list-style-type: none"> 0: user controlled PLMN selector with Access Technology EF_{PLMNwAcT}, if not found in the SIM/UICC then PLMN preferred list EF_{PLMNsel} (this file is only available in SIM card or GSM application selected in UICC) 1: operator controlled PLMN selector with Access Technology EF_{OPLMNwAcT} 2: HPLMN selector with Access Technology EF_{HPLMNwAcT}

7.8 PS Operator selection +UCGOPS

+UCGOPS						
Modules	LEON-G SARA-G LISA-U SARA-U					
Attributes	Syntax	PIN required	Settings saved	Can be aborted	Response time	Error reference
	partial	Yes	No	No	Up to 3 min	+CME Error

7.8.1 Description

Forces an attempt to select and register on the PS (Packet Switched) network operator either automatically selected by the MT, or manually specified by the user.

The read command returns the network on which the MT is PS attached to, if any.

The test command returns a list of the available networks, specifying if they are forbidden and if PS is supported.

The command in the execution syntax is abortable if a character is sent to DCE during the command execution. The <format> and <oper> parameter must be omitted if the value of <mode> parameter is 0.

7.8.2 Syntax

Type	Syntax	Response	Example
Set	AT+UCGOPS=[<mode>[,<format>[,<oper>[,<AcT>]]]]	OK	AT+UCGOPS=0 OK AT+UCGOPS=1,2,"22201" OK
Read	AT+UCGOPS?	+UCGOPS: <status>[,<format>,<oper>,<AcT>] OK	+UCGOPS: 1,2,"22210",0 OK
Test	AT+UCGOPS=?	+UCGOPS: [(<stat>,long alphanumeric <oper>, short alphanumeric <oper>, numeric <oper>[,<AcT>],[<ps_availability>]) [,<mode>],(list of supported <mode>s),(list of supported <format>s)] OK	+UCGOPS:(1,"vodafone IT","voda IT", "22210",1),(3,"I TIM","TIM","22201",1),(3,"I WIND","I WIND","22288",1),,(0-1),(0-2) OK

7.8.3 Defined values

Parameter	Type	Description
<mode>	Number	Specified whether the operator selection is done automatically by the MT or is manually bound to a specific network <ul style="list-style-type: none"> 0: automatic (<oper> field is ignored) 1: manual
<format>	Number	Mandatory parameter if <mode> value is 1, it specifies the format of the network operator name <ul style="list-style-type: none"> 0 (default value): long alphanumeric <oper> 1: short format alphanumeric <oper> 2: numeric <oper>
<oper>	String	String type given in format <format>; this field may be up to 16 character long for long alphanumeric format, up to 8 characters for short alphanumeric format and 5 characters long for numeric format (MCC/MNC codes); this parameter is mandatory if <mode> value is 1
<stat>	Number	PLMN status attribute with respect to the MT <ul style="list-style-type: none"> 0: unknown 1: available 2: current 3: forbidden
<ps_availability>	Number	GPRS availability

Parameter	Type	Description
		<ul style="list-style-type: none"> 0: not supported 1: supported
<AcT>	Number	Indicates the radio access technology and may be: <ul style="list-style-type: none"> 0: GSM 2: UTRAN (UMTS)
<status>	Number	Current GPRS registration status and PLMN selection mode of the MT <ul style="list-style-type: none"> 0: attached, automatic PLMN selection mode 1: attached, manual PLMN selection mode 2: detached

7.8.4 Notes

LEON-G / SARA-G

- The <AcT> parameter is not supported.

7.9 Network registration +CREG

+CREG						
Modules	LEON-G SARA-G					
	LISA-U SARA-U					
Attributes	Syntax	PIN required	Settings saved	Can be aborted	Response time	Error reference
	partial	No	No	No	-	+CME Error

7.9.1 Description

Controls the presentation of the URC **+CREG: <stat>** issued when <n>=1 and there is a change in the MT network registration status for CS services, or the URC **+CREG: <stat>[,<lac>,<ci>[,AcT]]** issued when <n>=2 and there is a change of the network cell.



When <n>=2, in UMTS RAT, during dedicated connections, unsolicited location information may be received if the network sends the UTRAN INFORMATION MOBILITY message (change of cells e.g. due to handovers are not reported). In GSM RAT, during a CS connection, no unsolicited location information is received.

7.9.2 Syntax

Type	Syntax	Response	Example
Set	AT+CREG=[<n>]	OK	AT+CREG=1 OK
Read	AT+CREG?	+CREG: <n>, <stat>[,<lac>,<ci>[,AcT]] OK	+CREG: 0,0 OK
Test	AT+CREG=?	+CREG: (list of the supported <n>s) OK	+CREG: (0-2) OK
URC		+CREG: <stat>[,<lac>,<ci>[,AcT]]	+CREG: 1,"4E54","44A5"

7.9.3 Defined values

Parameter	Type	Description
<n>	Number	<ul style="list-style-type: none"> 0 (default value and factory-programmed setting): disable network registration URC (default value) 1: enable network registration URC +CREG: <stat> 2: enable network registration and location information URC +CREG: <stat>[,<lac>,<ci>[,AcT]]
<stat>	Number	<ul style="list-style-type: none"> 0: not registered, MT is not currently searching a new operator to register to 1: registered, home network 2: not registered, but MT is currently searching a new operator to register to



Parameter	Type	Description
		<ul style="list-style-type: none">• 3: registration denied• 4: unknown• 5: registered, roaming
<lac>	String	Two bytes location area code in hexadecimal format (e.g. "00C3"). The value FFFF means that the current <lac> value is invalid.
<ci>	String	From 2 to 4 bytes cell ID in hexadecimal format (e.g. "A13F" or "129080B"). The value FFFFFFFF means that the current <ci> value is invalid.
<AcT>	Number	Indicates the radio access technology <ul style="list-style-type: none">• 0: GSM• 1: GSM COMPACT• 2: UTRAN• 3: GSM with EDGE availability• 4: UTRAN with HSDPA availability• 5: UTRAN with HSUPA availability• 6: UTRAN with HSDPA and HSUPA availability• 7: Reserved• 255: the current <AcT> value is invalid

7.9.4 Notes

The following is an overview of the values assumed by the <stat> parameter:

- 0: a technical problem could have occurred, the user is requested to intervene. It is still possible to make emergency calls if some network is available. Possible causes:
 - o PIN not entered
 - o Invalid HPLMN found on the SIM (SIM read error)
 - o SIM card not presentThe registration is not started (+COPS=2)
- 1: the MT is registered for circuit-switched services on the HPLMN (or on one of the equivalent HPLMN's, whose list is provided by the SIM)
- 2: the module is searching a network to register on. Possible causes:
 - o No network available
 - o Available networks have insufficient Rx level
 - o HPLMN or allowed PLMN are available but the registration is rejected, e.g. roaming is not allowed in this Location AreaIt is still possible to make emergency calls if network coverage is available
- 3: the CS registration failed after a Location Update Reject; possible causes are:
 - o Illegal MS
 - o Illegal ME
 - o IMSI unknown at HLR
 - o PLMN not allowed
 - o Location area not allowed
 - o Roaming not allowed in this location area
 - o Network failure
 - o Network congestionIt is still possible to make emergency calls if network coverage is available.

If the registration type is manual, then no further attempt is made to search for a new PLMN or register with it. If the registration type is automatic, the MS may look for an allowed PLMN if the rejection cause was roaming restriction. In case of illegal MS /ME, there could be possible problems with either the SIM card or with the ME's identity (IMEI): user intervention may be required

- 4: this value, usually transitory, is returned if the registration state does not belong to any of the following:



- o Normal
- o Limited
- o No service
- o Service detached
- o Service disabled

It may be issued after the failure of a registration procedure, before starting a PLMN search, when <stat>=2.

- 5: the MT is registered for circuit-switched services on a VPLMN, in national or international roaming

LISA-U1

- The <AcT> parameter is not supported.

LEON-G / SARA-G

- If GPRS is enabled and +CREG and +CGREG URCs are both enabled too, once the module is registered and attached then the two URCs are sent out quite at the same time.
- The <AcT> parameter is not supported.
- Equivalent HPLMN for <stat>=1 is not supported: <stat>=5 is indicated in this case.

7.10 HSDPA/HSUPA mode configuration +UHSDUPA

+UHSDUPA						
Modules	LISA-U SARA-U					
Attributes	Syntax	PIN required	Settings saved	Can be aborted	Response time	Error reference
	partial	No	NVM	No	-	+CME Error

7.10.1 Description

Enables / disables HSDPA and HSUPA also configuring the related data rate. The settings are saved in NVM at power off; the new configuration will be effective at the next power on.



u-blox cellular modules are certified according to all the capabilities and options stated in the Protocol Implementation Conformance Statement document (PICS) of the module. The PICS, according to 3GPP TS 51.010-2 [83] and 3GPP TS 34.121-2 [84], is a statement of the implemented and supported capabilities and options of a device. If the user changes the command settings during the certification process, the PICS of the application device integrating a u-blox cellular module must be changed accordingly.

7.10.2 Syntax

Type	Syntax	Response	Example
Set	AT+UHSDUPA=<HSDPA-mode>,<HSDSCH_category>[,<HSUPA-mode>[,<E-DCH category>]]	OK	AT+UHSDUPA=1,8,1,6 OK
Read	AT+UHSDUPA?	+UHSDUPA: <HSDPA-mode>,<HSDSCH_category>,<HSUPA-mode>,<E-DCH category> OK	+UHSDUPA: 1,8,1,6 OK
Test	AT+UHSDUPA=?	+UHSDUPA: (<list of supported <HSDPA-mode>s>),(<list of supported <HSDSCH_category>s>),(<list of supported <HSUPA-mode>s>),(<list of supported <E-DCH category>s>) OK	+UHSDUPA: (0-1),(6,8,10,12,13,14),(0,1),(1,2,6) OK

7.10.3 Defined values

Parameter	Type	Description
<HSDPA-mode>	Number	<ul style="list-style-type: none"> • 0: HSDPA OFF



Parameter	Type	Description
<HS-DSCH_category>	Number	<ul style="list-style-type: none"> • 1 (default and factory-programmed value): HSDPA ON HS-DSCH category defined in 3GPP TS 25.306 [53] <ul style="list-style-type: none"> • 6: category 6 • 8 (default and factory-programmed value): category 8 • 10: category 10 • 12: category 12 • 13: category 13 • 14: category 14
<HSUPA-mode>	Number	<ul style="list-style-type: none"> • 0: HSUPA OFF • 1 (default and factory-programmed value): HSUPA ON
<E-DCH category>	Number	E-DCH category defined in 3GPP TS 25.306 [53] <ul style="list-style-type: none"> • 1: category 1 • 2: category 2 • 4: category 4 • 6 (default and factory-programmed value): category 6

7.10.4 Notes

LISA-U2 / SARA-U

- <E-DCH category>=4 is not supported.

LISA-U200-00S

- <E-DCH category>=4 is supported.

LISA-U200 / LISA-U260 / LISA-U270 / SARA-U

- The <HS-DSCH_category> range goes from 6 to 8.

LISA-U230

- The <HS-DSCH_category> range goes from 6 to 14.
- The default value of <HS-DSCH_category> is 14.

LISA-U1

- The <HS-DSCH_category> range goes from 6 to 8.

7.11 Preferred operator list +CPOL

+CPOL						
Modules	LEON-G SARA-G					
	LISA-U SARA-U					
Attributes	Syntax	PIN required	Settings saved	Can be aborted	Response time	Error reference
	partial	Yes	No	No	< 10 s	+CME Error

7.11.1 Description

Edits the user preferred list of networks in the active application on the UICC (GSM or USIM) or preferred list of networks in the SIM card.

The command accesses the list of preferred PLMNs previously selected by +CPLS, if implemented. If +CPLS is not implemented the command tries to access EF_{PLMNwAcT} and if this file is not present and a UICC GSM application is selected or a SIM card is used then the EF_{PLMNsel} file is accessed.

The set command writes an entry in the selected list. When an entry is added to +CPOL list, it should have a correspondence in the ROM PLMN names returned by the +COPN command. If <index> is given but <oper> is left out, the entry is deleted. If only <format> is given, the <oper> format in the read command is changed. <GSM_AcT>, <GSM_Compact_AcT>, and <UTRAN_AcT> parameters are required when writing user controlled PLMN selector with Access Technology (EF_{PLMNwAcT}).



The read command returns all used entries from the SIM list of preferred PLMNs and where provided the Access Technologies for each PLMN in the list.

 If in the **+COPN** list there are more than one PLMN with the same name in alphanumeric (short or long) format, the numeric format shall be used to add this PLMN <entry> in the +CPOL list; otherwise the result will be unpredictable.

7.11.2 Syntax

Type	Syntax	Response	Example
Set	AT+CPOL=[<index>][,<format>[,<oper>[,<GSM_AcT>,<GSM_Compact_AcT>,<UTRAN_AcT>]]]	OK	AT+CPOL=2,0,"I WIND",1,0,1 OK
Read	AT+CPOL?	+CPOL: <index1>,<format>,<oper1>[,<GSM_AcT1>,<GSM_Compact_AcT1>,<UTRAN_AcT1>] [+CPOL: <index2>,<format>,<oper2>[,<GSM_AcT2>,<GSM_Compact_AcT2>,<UTRAN_AcT2>]...] OK	+CPOL: 1,0,"F SFR",1,0,1 +CPOL: 2,0,"TIM I",1,0,1 OK
Test	AT+CPOL=?	+CPOL: (list of supported<index>s),(list of +CPOL: (1-30),(0-2) supported <format>s) OK	OK

7.11.3 Defined values

Parameter	Type	Description
<index> / <indexn>	Number	Represents the order number of operator in the SIM preferred operator list
<format>	Number	See also +COPS command description <ul style="list-style-type: none"> • 0: long format alphanumeric <oper> • 1: short format alphanumeric <oper> • 2: numeric <oper>
<oper> / <opern>	String	Format indicated by <format>
<GSM_AcT>	Number	GSM access technology <ul style="list-style-type: none"> • 0: access technology not selected • 1: access technology selected
<GSM_Compact_AcT>	Number	GSM compact access technology <ul style="list-style-type: none"> • 0: access technology not selected • 1: access technology selected
<UTRAN_AcT>	Number	UTRA access technology <ul style="list-style-type: none"> • 0: access technology not selected • 1: access technology selected

7.11.4 Notes

LEON-G / SARA-G

- <GSM_AcT>, <GSM_Compact_AcT> and <UTRAN_AcT> parameters are not supported.

7.12 Read operator names +COPN

+COPN						
Modules	LEON-G SARA-G					
	LISA-U SARA-U					
Attributes	Syntax	PIN required	Settings saved	Can be aborted	Response time	Error reference
	full	Yes	No	No	-	+CME Error

7.12.1 Description

Returns the list of operator names from the MT. Each operator code <numeric n> that has an alphanumeric equivalent <alpha n> in the MT memory shall be returned.

7.12.2 Syntax

Type	Syntax	Response	Example
Action	AT+COPN	+COPN: <numeric 1>,<alpha1>	+COPN: "21901","T-Mobile HR"
		[+COPN: <numeric2>,<alpha2> [...]]	+COPN: "21910","HR VIP"
		OK	+COPN: "22201","I TIM" +COPN: "22210","vodafone IT"
Test	AT+COPN=?	OK	OK

7.12.3 Defined values

Parameter	Type	Description
<numeric n>	String	operator in numeric format (see Chapter 7.3 , +COPS AT command)
<alpha n>	String	operator in long alphanumeric format (see Chapter 7.3 , +COPS AT command)

7.13 Steering of Roaming configuration +UDCONF=20

+UDCONF=20						
Modules	LEON-G100-07S LEON-G100-08S SARA-G					
	LISA-U200-01S LISA-U200-02S LISA-U200-52S LISA-U200-62S LISA-U200-82S LISA-U230 LISA-U260 LISA-U270 SARA-U					
Attributes	Syntax	PIN required	Settings saved	Can be aborted	Response time	Error reference
	full	No	NVM	No	-	+CME Error

7.13.1 Description

Enables / disables the Steering of Roaming feature.

The setting can be changed only when the module is not registered to, and not searching for, a network (i.e. when +CREG's <stat> is 0). The new setting is saved in NVM and takes place at the next network registration / search.

7.13.2 Syntax

Type	Syntax	Response	Example
Set	AT+UDCONF=20,<SoR_enable>	OK	AT+UDCONF=20,1
			OK
Read	AT+UDCONF=20	+UDCONF: 20,<SoR_enable>	AT+UDCONF=20
		OK	+UDCONF: 20,1
			OK

7.13.3 Defined values

Parameter	Type	Description
<SoR_enable>	Number	Enables / disables the Steering of Roaming feature:

Parameter	Type	Description
		<ul style="list-style-type: none"> 0: Steering of Roaming disabled 1 (factory-programmed value): Steering of Roaming enabled

7.13.4 Notes

LEON-G / SARA-G

- The factory-programmed value of <SoR_enable> is 0.

7.14 Fast Dormancy activation +UFDAC

+UFDAC								
Modules	LISA-U200-02S	LISA-U200-52S	LISA-U200-62S	LISA-U200-82S	LISA-U260-02S	LISA-U270-02S	LISA-U270-62S	SARA-U
Attributes	Syntax	PIN required	Settings saved	Can be aborted	Response time	Error reference		
	full	No	NVM	No	-	+CME Error		

7.14.1 Description

Activates or deactivates the autonomous Fast Dormancy or triggers a single Fast Dormancy request depending on the specified mode. If all the constraints are satisfied a Signaling Connection Release Indication (SCRI) is sent to the network. There is no final confirmation if the SCRI was sent to the network, i.e. the "OK" response only indicates that the command's syntax has been fulfilled.

7.14.2 Syntax

Type	Syntax	Response	Example
Set	AT+UFDAC=[<FD_mode>[,<FD_Delay_Timer_duration>[,<FD_Inhibit_Timer_duration>]]]	OK	AT+UFDAC=1 OK
Read	AT+UFDAC?	+UFDAC: <FD_mode>,<FD_Delay_Timer_duration>,<FD_Inhibit_Timer_duration> OK	+UFDAC: 3,5,5 OK
Test	AT+UFDAC=?	+UFDAC: (list of the supported <FD_mode>s),(list of the supported <FD_Delay_Timer_duration>s),(list of the supported <FD_Inhibit_Timer_duration>s) OK	+UFDAC: (1-3),(1-60),(0,1-120) OK

7.14.3 Defined values

Parameter	Type	Description
<FD_mode>	Number	Indicates the action to perform: <ul style="list-style-type: none"> 1: one shot SCRI transmission request (application-driven FD) 2: activate automatic SCRI transmission request (autonomous FD) 3: deactivate automatic SCRI transmission request If omitted, only the delay and inhibit timer values are saved and no other action is performed.
<FD_Delay_Timer_duration>	Number	Delay Timer duration in seconds, range 1-60. The Delay Timer is used for the autonomous FD (<FD_mode>=2). When the module is in connected mode with no data available on the user plane this timer starts running. At its expiry, the evaluation for the SCRI transmission is done.
<FD_Inhibit_Timer_duration>	Number	Inhibit Timer duration in seconds, range 1-120 (the value 0 disables the Inhibit Timer). The Inhibit Timer is an extension of T323. If the network supports 3GPP R8 Fast Dormancy, the Inhibit Timer and T323 are the same and thus the timer's duration is network specified. Otherwise the value <FD_Inhibit_Timer_duration> is used.

7.14.4 Notes

- The Fast Dormancy feature is not available in GSM RAT.



- The set command updates the <FD_Delay_Timer_duration> and <FD_Inhibit_Timer_duration> values stored in NVM, if they are specified.
- If the timer parameters are omitted, their values previously stored in NVM are used.
- If automatic SCRI transmission request is active, one shot SCRI transmission requests are ignored.

Constraints to be satisfied before sending a SCRI

No 'relevant' RRC procedure is ongoing

Inhibit Timer is not running

No NAS signaling is ongoing

No data on the user plane was transferred during the last <FD_Delay_Timer_duration> seconds

Table 1: Constraints to be satisfied before sending a SCRI

7.15 Fast Dormancy configuration +UDCONF=61

+UDCONF=61						
Modules	LISA-U200-02S LISA-U200-52S LISA-U200-62S LISA-U200-82S LISA-U260-02S LISA-U270-02S LISA-U270-62S SARA-U					
Attributes	Syntax	PIN required	Settings saved	Can be aborted	Response time	Error reference
	full	No	NVM	No	-	+CME Error

7.15.1 Description

Configure the Fast Dormancy modes.

7.15.2 Syntax

Type	Syntax	Response	Example
Set	AT+UDCONF=61,<FD_conf>	OK	AT+UDCONF=61,1 OK
Read	AT+UDCONF=61	+UDCONF: 61,<FD_conf> OK	AT+UDCONF=61 +UDCONF: 61,2 OK

7.15.3 Defined values

Parameter	Type	Description
<FD_conf>	Number	Specifies which <FD_mode>'s values are allowed in the +UFDAC AT command. If a not allowed <FD_mode> value is issued, +UFDAC will display the message "+CME ERROR: operation not allowed": <ul style="list-style-type: none"> • 0: values 1 and 2 are not allowed in <FD_mode> • 1: value 2 is not allowed in <FD_mode> • 2 (factory-programmed value): all the <FD_mode> values are allowed

7.16 Network selection control +PACSP

+PACSP						
Modules	LISA-U SARA-U					
Attributes	Syntax	PIN required	Settings saved	Can be aborted	Response time	Error reference
	full	No	No	No	-	+CME Error

7.16.1 Description

Allows checking whether the EF_{CSP} (Customer Service Profile) is available on the SIM/USIM card and, if available, what is the value of the PLMN mode bit; otherwise the response is an error message ("+CME ERROR: operation not allowed" if +CME is set to 2).

The URC is enabled if EF_{CSP} (Customer Service Profile) is available: in this case it is output at boot time and whenever the SIM/USIM issues the REFRESH proactive command related to the EF_{CSP}.

EF_{CSP} is available on SIM/USIM cards from AT&T. This functionality will typically be used in cases where AT&T subscribers internationally travel, or if there is a need to enable manual network selection functionality.

For further information see the AT&T Device Requirements [61].

7.16.2 Syntax

Type	Syntax	Response	Example
Read	AT+PACSP?	+PACSP<bit_value> OK	+PACSP1 OK
URC		+PACSP<bit_value>	+PACSP0

7.16.3 Defined values

Parameter	Type	Description
<bit_value>	Number	PLMN mode bit value <ul style="list-style-type: none"> 0: automatic network selection is forced (see the following table) 1: network selection mode unchanged (see the following table)

7.16.4 Notes

- If EF_{CSP} is available, the PLMN mode bit forces the automatic network registration, according to the +COPS <mode> value which is loaded at boot from the selected profile (refer to [Appendix B.1](#) and [Chapter 14.27](#)). The following table explains the behavior:

Autoregistration <mode>	PLMN mode bit <bit_value>	Autoregistration behavior
0	0	Automatic network selection
1	0	Automatic network selection
2	0	Disabled
0	1	Automatic network selection
1	1	Manual network selection (search for the PLMN stored in the selected profile)
2	1	Disabled

7.17 Integrity check on test networks configuration +UDCONF=81

+UDCONF=81						
Modules	LISA-U200-02S LISA-U200-52S LISA-U200-62S LISA-U200-82S LISA-U260-02S LISA-U270-02S LISA-U270-62S SARA-U					
Attributes	Syntax	PIN required	Settings saved	Can be aborted	Response time	Error reference
	full	No	No	No	-	+CME Error

7.17.1 Description

Configures the integrity check on 3G test networks.



Integrity check on 3G test networks shall be disabled only when the authentication and integrity are disabled on the 3G test network on which the module will be registered.

7.17.2 Syntax

Type	Syntax	Response	Example
Set	AT+UDCONF=81,<integrity_check_enabled>	OK	AT+UDCONF=81,0 OK
Read	AT+UDCONF=81	+UDCONF: 81,<integrity_check_enabled> OK	AT+UDCONF=81 +UDCONF: 81,1 OK

7.17.3 Defined values

Parameter	Type	Description
<integrity_check_enabled>	Number	Integrity check on 3G test networks configuration. Allowed values: <ul style="list-style-type: none"> • 0: integrity check on test networks disabled (MCC/MNC not available in +<i>COPN</i> set command's response) • 1 (factory-programmed value): integrity check on test networks enabled (MCC/MNC not available in +<i>COPN</i> set command's response)

7.18 Select band +UBANDSEL

+UBANDSEL						
Modules	LEON-G SARA-G					
	LISA-U SARA-U					
Attributes	Syntax	PIN required	Settings saved	Can be aborted	Response time	Error reference
	full	No	<i>NVM</i>	No	-	+ <i>CME Error</i>

7.18.1 Description

Allows switching from automatic band selection to selection of one or more (up to four) bands from the following:

- 2G network
 - o 850 MHz
 - o 900 MHz
 - o 1800 MHz
 - o 1900 MHz
- 3G network
 - o 800 MHz (Band VI)
 - o 850 MHz (Band V)
 - o 900 MHz (Band VIII)
 - o 1500 MHz (Band XI)
 - o 1700 MHz (Band IV)
 - o 1800 MHz (Band III)
 - o 1900 MHz (Band II)
 - o 2100 MHz (Band I)
 - o 2600 MHz (Band VII)

 u-blox cellular modules are certified according to all the capabilities and options stated in the Protocol Implementation Conformance Statement document (PICS) of the module. The PICS, according to 3GPP TS 51.010-2 [83] and 3GPP TS 34.121-2 [84], is a statement of the implemented and supported capabilities and options of a device. If the user changes the command settings during the certification process, the PICS of the application device integrating a u-blox cellular module must be changed accordingly.

 LISA-U / SARA-U

The list of supported bands presents exclusively GSM or UMTS bands depending on which RAT the MT is currently registered. If it is not registered, the bands presented depend on +URAT command:

- If in single mode, depends on <AcT>
- If in dual mode, depends on <PreferredAct> (thus the command forces a single mode behavior)

 The MT will camp on a cell, if suitable, belonging to one of the selected band; the OK response is regardless of the result of the camping on the new cell.

 To have effective the setting, the module must be deregistered and registered again (using the commands +COPS=2, +COPS=0).

 The configuration is saved in NVM for future registration attempts.

7.18.2 Syntax

Type	Syntax	Response	Example
Set	AT+UBANDSEL=<band_1>[,<band_2>[, ...]]	OK	AT+UBANDSEL=900 OK
Read	AT+UBANDSEL?	+UBANDSEL: <band_1>[,<band_2>[,...]] OK	+UBANDSEL: 850,900,1800,1900 OK
Test	AT+UBANDSEL=?	+UBANDSEL: (list of supported <band_x>) OK	+UBANDSEL: (0,850,900,1800,1900) OK

7.18.3 Defined values

Parameter	Type	Description
<band_x>	Number	<ul style="list-style-type: none"> 0: restore the factory-programmed configuration of the module 800: selection of 800 MHz band 850: selection of 850 MHz band 900: selection of 900 MHz band 1500: selection of 1500 MHz band 1700: selection of 1700 MHz band 1800: selection of 1800 MHz band 1900: selection of 1900 MHz band 2100: selection of 2100 MHz band 2600: selection of 2600 MHz band

7.19 Cell environment description +CGED

+CGED						
Modules	LEON-G SARA-G LISA-U SARA-U					
Attributes	Syntax	PIN required	Settings saved	Can be aborted	Response time	Error reference
	partial	No	No	No	-	+CME Error

7.19.1 Description

Provides the cell environment information that can be periodic (with a period of 5 s) or performed only once. The response syntax for the set command depends whether the UMTS is supported and if it is, by the supported RAT (GSM, UMTS).

When <mode> parameter is set to 0, 1, 128 or 129 the neighbor cell content may be available up to 6 times.

When <mode> parameter is set to 3, 4, 131 or 132:

- The serving cell information includes the following data: <MCC>, <MNC>, <LAC>, <CI>, <BSIC>, <arfcn>, <Arfcn_ded>

When <mode> parameter is set to 5, 6, 133 or 134:

- Serving cell information includes only the following data: <MCC>, <MNC>, <LAC>, <CI>, <BSIC> <arfcn>, <RxLev>, <Arfcn_ded>, <RxLevSub>, <t_adv>
- Neighbor cell information includes the following data: <MCC>, <MNC>, <LAC>, <CI>, <BSIC> <arfcn>, <RxLev>
- Information on neighbor cells contained in radio resource BA List is reported. The neighbor cell content may be available up to 32 times in idle-mode, up to 6 in dedicated-mode; in packet transfer mode (PDP context active) no reporting is possible on AT UART as it is used for data transfer (MUX can be used to create two virtual serial ports, one for data transfer, one for AT commands)

 LISA-U



<mode> parameter cannot set to 5 or 6.

In case of UMTS radio access technology:

- The maximum number of displayable cells is 56 (32 reserved for 3G cells and 24 for 2G cells)
- The syntax for cell information differs in the channel type

In case of 2G radio access technology the total number of 2G cells may be available up to 6 times.

 An Equivalent PLMN (Public Land Mobile Network) is a PLMN equivalent to the RPLMN (Registered PLMN). The MT has a list of EPLMN's that is updated (deleted, changed...) at the end of each location update procedure, routing area update procedure and GPRS attach procedure.

7.19.2 Syntax

Type	Syntax	Response	Example
Set	AT+CGED=[<mode>[,<details>]]	Response syntax in case 3G is not supported +CGED: Service-Cell: MCC: <MCC>, MNC: <MNC>, LAC: <LAC>, CI: <CI>, BSIC: <BSIC> [Equivalent PLMNs: MCC: <MCC>, MNC: <MNC>] Arfcn: <arfcn>, [RxLevServ: <RxLevServ>,] [RfChannels: <RfChannels>] Arfcn_ded: <Arfcn_ded>, [RxLevFull: <RxLevFull>,] [RxLevSub: <RxLevSub>] [RxQualFull: <RxQualFull>, RxQualSub: <RxQualSub>], Ciphering: <ciphering> ms_txpwr: <ms_txpwr>, rx_acc_min: <rx_acc_min>, cbq: <cbq>, cba: <cba>, c2_valid: <c2_valid>, cr_offset: <cr_offset>, tmp_offset: <tmp_offset>, penalty_t: <penalty_t>, c1: <c1>, c2: <c2>, ch_type: <ch_type>, ch_mode: <ch_mode>, txpwr: <txpwr>, dtx_used: <dtx_used>, t3212: <t3212>, acc: <acc>],[t_adv: <t_adv>] [bs_pa_mfrms: <bs_pa_mfrms>, dsc: <dsc>, rll: <rll>] Neighbour Cell <n>: MCC: <MCC>, MNC: <MNC>, LAC: <LAC>, CI: <CI>, BSIC: <BSIC>, Arfcn: <arfcn>, [RxLev: <RxLev>] [C1_nc: <C1_nc>, C2_nc: <C2_nc>] [GPRS-Parameters: GPRS_sup: <GPRS_sup>, RAC: <RAC>, SplitPg: <SplitPg>, NCO: <NCO>, NOM: <NOM>, T3192: <T3192>, Acc_Burst_type: <Acc_Burst_type>, DRX_Timer_Max: <DRX_Timer_Max>, PBCCH: <PBCCH>, Ext_Measure_Order: <Ext_Measure_Order>, PSII_r_per: <PSII_r_per>, Count_LR: <Count_LR>, Count_HR: <Count_HR>, C_R_Hyst: <C_R_Hyst>, C31: <C31>, C32: <C32>, Prior_Acc_Thr: <Prior_Acc_Thr>] OK	3G not supported: AT+CGED=0 +CGED: Service Cell: MCC: 1, MNC: 1, LAC: 0001, CI: 0000, BSIC: 0d Equivalent PLMNs: MCC: 1, MNC: 1 Arfcn: 00020, RxLevServ: 025, RfChannels: 000, Arfcn_ded: INVALID_ARFCN, RxLevFull: 255, RxLevSub: 255, RxQualFull: 255, RxQualSub: 255, Ciphering: OFF, ms_txpwr: 000, rx_acc_min: 000, cbq: 00, cba: 00, c2_valid: True, cr_offset: 000, tmp_offset: 000, penalty_t: 1f, c1: 19, c2: 19, ch_type: ff, ch_mode: ff, txpwr: 255, dtx_used: True, t3212: 00000, acc: 0000, t_adv: 000, bs_pa_mfrms: 002, dsc: 000, rll: 255 Neighbour Cell 1: MCC: 65535, MNC: 255, LAC: 0000, CI: 0000, BSIC: ff, Arfcn: 00025, RxLev: 000, C1_nc: -1, C2_nc: -32000, Neighbour Cell 2: MCC: 65535, MNC: 255, LAC: 0000, CI: 0000, BSIC: ff, Arfcn: 00070, RxLev: 000, C1_nc: -1, C2_nc: -32000, GPRS-Parameters: GPRS_sup: True, RAC: 01, SplitPg: False, NCO: 00000, NOM: 001, T3192: 01f4, Acc_Burst_type: 00015, DRX_Timer_Max: 00, PBCCH: False, Ext_Measure_Order: 00000, PSII_r_per: 00, Count_LR: 00, Count_HR: 01, C_R_Hyst: 00, C31: -1, C32: 19, Prior_Acc_Thr: 06



Type	Syntax	Response	Example
			OK
		Response syntax for 3G cells:	Response for 3G cells::
		+CGED: RAT:<rat>, URR:<rrc_state>, DC:<urrcdc_state>, BP:<urrcbp_state>, M:<urrcm_state>, ERR:<as_error_code>, RC:<release_cause>, OOS:<out_of_service>, BLER:<meas_bler>, TSIR:<target_sir>, MSIR:<meas_sir>, HSC:<hierarchical_cell_structure>, HMD:<high_mobility_detected>, LM:<limited_service>, Cell-ID:<cell_identity>, DLF:<dl_frequency>, ULF:<ul_frequency>, SC:<scrambling_code>, RSCP LEV:<rscp_lev>, ECN0 LEV:<ecn0_lev>, C:<ciphering>, D:<ps_data_transferred>, PSM:<power_saving_mode>, [Cell:<cell_type>=AS, SC:<scrambling_code>, RSCP LEV:<rscp_lev>, ECN0 LEV:<ecn0_lev>, DLF:<dl_frequency>] [Cell:<cell_type>=VAS, SC:<scrambling_code>, RSCP LEV:<rscp_lev>, ECN0 LEV:<ecn0_lev>, DLF:<dl_frequency>] [Cell:<cell_type>=M, SC:<scrambling_code>, RSCP LEV:<rscp_lev>, ECN0 LEV:<ecn0_lev>, DLF:<dl_frequency>] [Cell:<cell_type>=D, SC:<scrambling_code>, RSCP LEV:<rscp_lev>, ECN0 LEV:<ecn0_lev>, DLF:<dl_frequency>] [Cell:<cell_type>=G, B:<gsm_band>, Arfcn:<arfcn>, RXLEV:<RxLev>, Bsic:<BSIC>, RV:<ranking_value>] [Cell:<cell_type>=U, SC:<scrambling_code>, RSCP LEV:<rscp_lev>, ECN0 LEV:<ecn0_lev>, DLF:<dl_frequency>, RV:<ranking_value>] [Cell:<cell_type>=NU, SC:<scrambling_code>, RSCP LEV:<rscp_lev>, ECN0 LEV:<ecn0_lev>, DLF:<dl_frequency>, RS:<ranking_status>] [Cell:<cell_type>=NG B:<gsm band>, Arfcn:<arfcn>, RXLEV:<RxLev>, Bsic:<BSIC>, RS:<ranking_status>] RR measurement evaluation: MeasId:<meas_id>, EventId:<event_id>, <par 3>, <par 4>, <par 5>, <par 6>,..., <par N>, MeasId:<meas_id>, EventId:, <par 3>, <par 4>, <par 5>, <par 6>,..., <par M>, etc... MM: Process:CO, MMs:<mm_state>, MMSs:<mm_service_state>, MSC:<ms_class>, T:<active_timer_bitmap> Process:CS, MMs:<mm_state>, MMSs:<mm_service_state>, LUS:<mm_	+CGED: RAT:"UMTS", URR:"ID" DC:002, BP:0005, M:003, ERR: 0, RC: 0, OOS:0, BLER:-,TSIR:-,MSIR:- HCS:0, HMD:0, LM:0, Cell-ID:016578c, DLF:10813, ULF: 9863, SC:138, RSCP LEV: 12, ECN0 LEV: 23, C:0, D:0, PSM:0 Cell:U, SC:6, RSCP LEV:13, ECN0 LEV:28, DLF:10813, RV:65523, Cell:NU, SC:81, RSCP LEV:7, ECN0 LEV:16, DLF:10813, RS:6, Cell:NU, SC:133, RSCP LEV:8, ECN0 LEV:12, DLF:10813, RS:6, Cell:NU, SC:98, RSCP LEV:7, ECN0 LEV:11, DLF:10813, RS:6, Cell:NU, SC:127, RSCP LEV:0, ECN0 LEV:0, DLF:10813, RS:6, Cell:NG, B:, Arfcn:53, RXLEV:0, Bsic:48, RS:1 Cell:NG, B:, Arfcn:69, RXLEV:0, Bsic:51, RS:1 Cell:NG, B:, Arfcn:70, RXLEV:0, Bsic:55, RS:1 Cell:NG, B:, Arfcn:70, RXLEV:0, Bsic:49, RS:1 Cell-ID:016578c, DLF:10813, ULF: 9863, SC:138, RSCP LEV: 12, ECN0 LEV: 23, C:0, D:0, PSM:0 Cell:U, SC:6, RSCP LEV:13, ECN0 LEV:28, DLF:10813, RV:65523, Cell:NU, SC:81, RSCP LEV:7, ECN0 LEV:16, DLF:10813, RS:6, Cell:NU, SC:133, RSCP LEV:8, ECN0 LEV:12, DLF:10813, RS:6, Cell:NU, SC:98, RSCP LEV:7, ECN0 LEV:11, DLF:10813, RS:6, Cell:NU, SC:127, RSCP LEV:0, ECN0 LEV:0, DLF:10813, RS:6, Cell:NG, B:, Arfcn:53, RXLEV:0, Bsic:48, RS:1 Cell:NG, B:, Arfcn:69, RXLEV:0, Bsic:51, RS:1 Cell:NG, B:, Arfcn:70, RXLEV:0, Bsic:55, RS:1 Cell:NG, B:, Arfcn:70, RXLEV:0, Bsic:49, RS:1 Cell-ID:016578c, DLF:10813, ULF: 9863, SC:138, RSCP LEV: 12, ECN0 LEV: 23, C:0, D:0, PSM:0 Cell:U, SC:6, RSCP LEV:13, ECN0 LEV:28, DLF:10813, RV:65523, Cell:NU, SC:81, RSCP LEV:7, ECN0 LEV:16, DLF:10813, RS:6, Cell:NU, SC:133, RSCP LEV:8, ECN0 LEV:12, DLF:10813, RS:6, Cell:NU, SC:98, RSCP LEV:7, ECN0 LEV:11, DLF:10813, RS:6, Cell:NU, SC:127, RSCP LEV:0, ECN0 LEV:0, DLF:10813, RS:6, Cell:NG, B:, Arfcn:53, RXLEV:0, Bsic:48, RS:1 Cell:NG, B:, Arfcn:69, RXLEV:0, Bsic:51, RS:1 Cell:NG, B:, Arfcn:70, RXLEV:0, Bsic:55, RS:1 Cell:NG, B:, Arfcn:70, RXLEV:0, Bsic:49, RS:1 RR measurement evaluation: MeasId: 0, EventId: 0A, 0, 0, 0, 0, 0, 0



Type	Syntax	Response	Example
		update_status>, T:<active_timer_bitmap>, L:<limited_service> Process:PS, MMs:<mm_state>, MMSs:<mm_service_state>, LUS:<mm_update_status>, T:<active_timer_bitmap>, L:<limited_service>, GS:<gprs_supported>, R:<ready_state> Cell change counters: CRT:<cell_reselecection_total>, IRCR:<ir_cell_reselecection>, AIRCR:<attempted_ir_cell_reselecection>,IRHO:<ir_handover>, AIRHO:<attempted_ir_handover> Equivalent PLMNs: MCC:<mobile_country_code>, MNC:<mobile_network_code> Serving PLMN: MCC:<mobile_country_code>, MNC:<mobile_network_code>, LAC:<location_area_code>, RAC:<routing_area_code> OK	MeasId: 0, EventId: 0A, 0, 0, 0, 0, 0, 0 MeasId: 0, EventId: 0A, 0, 0, 0, 0, 0, 0 MM: Process:CO, MMs: 4, MMSs:16, MSC:A, T: 0 Process:CS, MMs: 5, MMSs: 5, LUS:1, T:004, L:0 Process:PS, MMs: 9, MMSs: 5, LUS:1, T:0008, L:0, GS: d, R:0 Cell change counters: CRT: 0, IRCR: 0 AIRCR: 0, IRHO: 0, AIRHO: 0 Equivalent PLMNs: MCC:222, MNC: 10 Serving PLMN: MCC:222, MNC: 10, LAC:25071, RAC: 20 OK
		Response syntax for 2G cells: +CGED: RAT: <rat>, RR:<grr_state> SFRLC:<signal_failure/radio_link_counter>, RSR:<reselection_reason>, RC:<release_cause>, LM:<limited_service> B:<gsm_band>, Arfcn:<arfcn>, RXLEV:<RxLev>, C1:<C1>, C2:<C2>, Bsic:<BSIC>, MA:<nr_of_rf_in_ma>, MADed:<dedicated_arfcn>, GSM: Ci:<CI>, B:<gsm_band>, Arfcn:<arfcn>,RXLEV:<RxLev>, C1:<C1>, Bsic:<BSIC> UMTS: SC:<scrambling_code>, RSCP LEV:<rscp_lev>, ECNO LEV:<ecn0_lev>, DLF:<dl_frequency> MM: Process:CO, MMs:<mm_state>, MMSs:<mm_service_state>, MSC:<ms_class>, T:<active_timer_bitmap> Process:CS, MMs:<mm_state>, MMSs:<mm_service_state>, LUS:<location_update_status>, T:<active_timer_bitmap>, L:<limited_service> Process:PS, MMs:<mm_state>, MMSs:<mm_service_state>, LUS:<location_update_status>, T:<active_timer_bitmap>, L:<limited_service>, GS:<gprs_supported>, R:<ready_state> Cell change counters:	Response syntax for 2G cells: +CGED: RAT:"GSM", RR:11 SFRLC: 0, RSR:10, RC: 0, LM:0 B:"G", Arfcn: 989, RXLEV: 60, C1:54, C2:60, Bsic:0d, MA:0, MADed:65535 GSM: Ci:5265, B:"G", Arfcn: 9, RXLEV: 6, C1: 4, Bsic:11 GSM: Ci:ffff, B:"G", Arfcn: 3, RXLEV: 0, C1: 0, Bsic:ff GSM: Ci:ffff, B:"G", Arfcn: 25, RXLEV: 0, C1: 0, Bsic:ff GSM: Ci:ffff, B:"G", Arfcn: 41 RXLEV: 0, C1: 0, Bsic:ff MM: Process:CO, MMs: 4, MMSs: 0, MSC:G, T:0000 Process:CS, MMs: 5, MMSs: 5, LUS:1, T:0000, L:0 Process:PS, MMs: 9, MMSs: 5, LUS:1, T:0010, L:0, GS:1, R:1 Cell change counters: CRT: 0, IRCR: 0 AIRCR: 0, IRHO: 0, AIRHO: 0 Coding Scheme: dl_sc:NB_CS_1, ul_sc: Equivalent PLMNs: MCC: 1, MNC: 1 Serving PLMN: MCC: 1, MNC: 1, LAC: 1, RAC: 1, AcT:1



Type	Syntax	Response	Example
		CRT:<cell_reselecection_total> IRCR:<ir_cell_reselecection_counter> AIRCR:<attempted_ir_cell_reselecection> IRHO:<ir_handover> AIRHO:<attempted_ir_handover> Coding Scheme: dl_sc:<dl_sc>,ul_sc:<ul_sc> Equivalent PLMNs: MCC:<MCC>, MNC:<MNC> Serving PLMN: MCC:<MCC>, MNC:<MNC> LAC:<LAC>, RAC:<RAC>, AcT:<AcT> GPRS-Parameters: SplitPg:<SplitPg>,NCO:<NCO> NOM:<NOM>, T3192:<T3192> Acc_Burst_type:<Acc_Burst_type> DRX_Timer_Max:<DRX_Timer_Max> PBCCH:<PBCCH> Ext_Measure_Order:<Ext_Measure_Order> PSII_r_per:<PSII_r_per>, si13_location: <si13_location> packet_psi_status:<packet_psi_status> packet_si_status:<packet_si_status> ext_upl_tbf_supported:<ext_upl_tbf_supported> ccn_active:<ccn_active> pfc_feat_supported:<pfc_feat_supported> Count_LR:<Count_LR>, Count_HR:<Count_HR> C_R_Hyst:<C_R_Hyst> C31:<C31>, C32:<C32>, Prior_Acc_Thr:<Prior_Acc_Thr> OK	GPRS-Parameters: SplitPg:False, NCO:00000, NOM:001, T3192:01f4, Acc_Burst_type:00015, DRX_Timer_Max:00, PBCCH:False, Ext_Measure_Order:00000, PSII_r_per:00 si13_location:"BCCH_NORM" packet_psi_status:False, packet_si_status:False, ext_upl_tbf_supported:False, ccn_active:False, pfc_feat_supported:False Count_LR:00, Count_HR:01, C_R_Hyst:06, C31:-0001, C32:00054, Prior_Acc_Thr:06 OK
Read	AT+CGED?	+CGED: <mode> OK	+CGED: 0 OK
Test	AT+CGED=?	+CGED: (list of supported <mode>s) OK	+CGED: (0-6) OK

7.19.3 Defined values

Parameter	Type	Description
<mode>	Number	<ul style="list-style-type: none"> 0 (default value): one shot dump 1: periodic refreshed dump: the neighbor cell content may be repeated up to 6 times 2: stop periodic dump 3: one shot serving cell dump 4: periodic serving cell refreshed dump 5: one shot serving cell and neighbor cells dump 6: periodic serving cell and neighbor cells refreshed dump 128: one shot without the tags (e.g. MCC, RxLev will not be printed, refer to the command example)

Parameter	Type	Description
		<ul style="list-style-type: none"> 129: periodic refreshed dump without the tags (e.g. MCC, RxLev will not be printed, refer to the command example) 130: stop periodic dump (same as 2) 131: one shot serving cell without the tags (e.g. MCC, RxLev will not be printed, refer to the command example) 132: periodic serving cell refreshed without the tags (e.g. MCC, RxLev will not be printed, refer to the command example) 133: one shot serving cell and neighbor cells without the tags (e.g. MCC, RxLev will not be printed, refer to the command example) 134: periodic serving cell and neighbor cells refreshed without the tags (e.g. MCC, RxLev will not be printed, refer to the command example)
<details>	Number	<ul style="list-style-type: none"> 0 (default value): does not display <scrambling_code> if <mode>=3 or <mode>=4 is set 1: displays <scrambling_code> if <mode>=3 or <mode>=4 is set
<MCC>	Number	Mobile country code, range 0-999 (3 digits)
<MNC>	Number	Mobile network code, range 0-999 (1 to 3 digits)
<LAC>	Number	Location area code, range 0h-FFFFh (2 octets)
<CI>	Number	Cell Identity, range 0h-FFFFh (2 octets)
<BSIC>	Number	Base Station Identify Code, range 0h-3Fh (6 bits)
<arfcn>	Number	Absolute radio frequency channel number, range 0-1023
<RxLev>	Number	Received signal level on the cell, range 0-63; refer to 3GPP TS 05.08 [28]
<RxLevServ>	Number	Received signal level on the cell, range 0-63; refer to 3GPP TS 05.08 [28]
<RfChannels>	Number	Number of frequencies in Mobile Allocation: 0x01 if single RF and 0 if n.a.; refer to 3GPP TS 04.18 [40]
<Arfcn_ded>	Number	Single ARFCN of dedicated channel; it's the first ARFCN of Mobile Allocation
<RxLevFull>	Number	Received signal strength on serving cell, measured on all slots; range 0h-3Fh; refer to 3GPP TS 04.18 [40]
<RxLevSub>	Number	Received signal strength on serving cell, measured on a subset of slots; range 0h-3Fh; refer to 3GPP TS 04.18 [40]
<RxQualFull>	Number	Received signal quality on serving cell, measured on all slots; range 0-7; refer to 3GPP TS 04.18 [40]
<RxQualSub>	Number	Received signal quality on serving cell, measured on a subset of slots, range 0-7; refer to 3GPP TS 04.18 [40]
<ciphering>	Number	GSM Ciphering; the supported values are <ul style="list-style-type: none"> ON OFF
<ms_txpwr>	Number	Maximum TX power level an MT may use when accessing the system until otherwise commanded, range 0-31; refer to 3GPP TS 04.18 [40]
<rx_acc_min>	Number	RXLEV-ACCESS-MIN, range 0-63; refer to 3GPP TS 04.18 [40]
<cbq>	Number	CELL_BAR_QUALIFY, range 0-1; refer to 3GPP TS 05.08 [28]
<cba>	Number	CELL_BAR_ACCESS, range 0-1; refer to 3GPP TS 05.08 [28]
<c2_valid>	Number	True if all parameter for calculation of c2 are available; range 0-1
<cr_offset>	Number	CELL_RESELECT_OFFSET, range 0-63 (6 bit); refer to 3GPP TS 04.18 [40]
<tmp_offset>	Number	TEMPORARY_OFFSET, range 0-7; refer to 3GPP TS 04.18 [40]
<penalty_t>	Number	Penalty time, range 0-31; refer to 3GPP TS 04.18 [40]
<c1>, <C1_nc>	Number	Value of c1; refer to 3GPP TS 05.08 [28]
<c2>, <C2_nc>	Number	Value of c2; refer to 3GPP TS 05.08 [28]
<ch_type>	Number	Channel type of the current connection (refer to 3GPP TS 04.18 [40]): <ul style="list-style-type: none"> 0: invalid channel type 1: TCH/F 2: TCH/H 3: SDCCH/4 4: SDCCH/8
<ch_mode>	Number	Channel mode of current connection (refer to 3GPP TS 04.18 [40]): <ul style="list-style-type: none"> 0: signalling only 1: speech full rate 2: speech half rate 3: data full rate, 12.0 kb/s radio interface rate



Parameter	Type	Description
		<ul style="list-style-type: none"> • 4: data full rate, 6.0 kb/s radio interface rate • 5: data half rate, 6.0 kb/s radio interface rate • 6: data full rate, 3.6 kb/s radio interface rate • 7: data half rate, 3.6 kb/s radio interface rate • 8: speech full rate version 2 • 9: speech full rate version 3 • 10: speech half rate version 2 • 11: speech half rate version 3
<txpwr>	Number	Transmit power level of the current connection, range 0-31 or 255 if the module is not connected; refer to 3GPP TS 04.18 [40]
<dtx_used>	Number	DTX used, range 0-1; refer to 3GPP TS 04.18 [40]
<t3212>	Number	T3212. The T3212 timeout value field is coded as the binary representation of the timeout value for periodic updating in decihours; range 0-255 (8 bits); refer to 3GPP TS 04.18 [40]
<acc>	Number	Access control class (RACH Control Parameters); refer to 3GPP TS 04.18 [40]
<t_adv>	Number	Timing Advance, it is valid during a connection and it will updated during the next connection; refer to 3GPP TS 04.18 [40]
<bs_pa_mfrms>	Number	BS_PA_MFRMS (multiframe period for transmission of PAGING REQUEST), range 0-7 mapped to 2-9; refer to 3GPP TS 05.02 [42]
<dsc>	Number	Downlink Signalling Counter
<rl>	Number	Radio Link Loss Counter

GPRS-Parameters:

Parameter	Type	Description
<GPRS_sup>	Number	GPRS supported (in serving cell); range 0-1; refer to 3GPP TS 04.18 [40]
<RAC>	Number	Routing Area Code, range 0h-FFh (1 octet); refer to 3GPP TS 04.18 [40]
<SplitPg>	Number	SPGC_CCCH_SUP split pg_cycle on ccch by network, range 0-1 (2 bits); refer to 3GPP TS 04.18 [40]
<NCO>	Number	NETWORK_CONTROL_ORDER (GPRS_Cell_Options), range 0-3 (2 bits); refer to 3GPP TS 04.18 [40]
<NOM>	Number	NETWORK OPERATION MODE (GPRS_Cell_Options), range 0-3 (2 bits); refer to 3GPP TS 04.18 [40]
<T3192>	Number	T3192 (Wait for Release of the TBF after reception of the final block), range 0-7 mapped to 0-1500 msec (3 bits); refer to 3GPP TS 04.60[41]: <ul style="list-style-type: none"> • 0: 500 ms • 1: 1000 ms • 2: 1500 ms • 3: 0 ms • 4: 80 ms • 5: 120 ms • 6: 160 ms • 7: 200 ms
<Acc_Burst_type>	Number	ACCESS_BURST_TYPE, range 0-1 (mapped to 8-bit format, 11-bit format); refer to 3GPP TS 04.60 [41]
<DRX_Timer_Max>	Number	DRX_TIMER_MAX, range 0-7 (3 bits); refer to 3GPP TS 04.60[41]
<PBCCH>	Number	PBCCH present, range 0-1
<Ext_Measure_Order>	Number	EXT_MEASUREMENT_ORDER, range 0-3 (2 bits); refer to 3GPP TS 04.60 [41]
<PSII_r_per>	Number	PSII_REPEAT_PERIOD, range 0-15 mapped to 1-16 (4 bits); refer to 3GPP TS 04.60 [41]
<Count_LR>	Number	PSI_COUNT_LR, range 0-63 (6 bits); refer to 3GPP TS 04.60 [41]
<Count_HR>	Number	PSI_COUNT_HR, range 0-15 mapped to 1-16 (4 bits); refer to 3GPP TS 04.60 [41]
<C_R_Hyst>	Number	CELL_RESELECT_HYSTERESIS, range 0-7 (3 bits); refer to 3GPP TS 04.60 [41]
<C31>	Number	Value of c31, Number; refer to 3GPP TS 05.08 [28]
<C32>	Number	Value of c32, Number; refer to 3GPP TS 05.08 [28]
<Prior_Acc_Thr>	Number	PRIORITY_ACCESS_THR, range 0-7 (3 bits); refer to 3GPP TS 04.18 [40]

UMTS-Parameters:



Parameter	Type	Description
<rrc_state>	String	<ul style="list-style-type: none">• "CD": CELL_DCH(0)• "CF": CELL_FACH(1)• "CP": CELL_PCH(2)• "UP": URA_PCH(3)• "ID": IDLE(4)• "ST": START(5)
<urrcdc_state>	Number	Consists of three hex digits (octet 1, 2: event, 3: state). For debug purposes only
<urrcbp_state>	Number	Consists of four hex digits (octet 1, 2: event, 3, 4: state). For debug purposes only
<urrcm_state>	Number	Consists of three hex digits (octet1, 2: event, 3: state). For debug purposes only.
<as_error_code>	Number	indicates if an AS error occurred; possible values: <ul style="list-style-type: none">• 0: no error• 81: UMAC, no TFCI (Transport Format Code identifier) found• 82: UMAC, RLC timing error
<release_cause>	Number	MM RR release cause. For debug purposes only
<out_of_service>	Number	Service state: <ul style="list-style-type: none">• 0: Service present• 1: Out of service
<meas_bler>	Number	Measured BLER (Block error Rate). Possible values: <ul style="list-style-type: none">• range: 0.000001 to 0.99• if out of range : -
<target_sir>	Number	Targeted SIR (Signal to Interference Ratio). Possible values: <ul style="list-style-type: none">• range: -10 to 20• if out of range : -
<meas_sir>	Number	Measured SIR (Signal to Interference Ratio). Possible values: <ul style="list-style-type: none">• range: -10 to 20• if out of range : -
<hierarchical_cell_structure>	Number	HCS (Hierarchical Cell Structure) <ul style="list-style-type: none">• 0: not used• 1: used
<high_mobility_detect>	Number	High mobility: <ul style="list-style-type: none">• 0: not detected• 1: detected
<cell_identity>	Number	Cell identity (eight hex digits)
<dl_frequency>	Number	Downlink frequency. Range 0-16383
<ul_frequency>	Number	Uplink frequency. Range 0-16383
<ciphering>	String	Ciphering: <ul style="list-style-type: none">• 1: enabled• 2: disabled
<ps_data_transferred>	Number	PS data: <ul style="list-style-type: none">• 0: transferred• 1: not transferred
<power_saving_mode>	Number	Power saving: <ul style="list-style-type: none">• 0: disabled• 1: enabled
<cell_type>	String	Cell type: <ul style="list-style-type: none">• "AS": Active Set• "VAS": Virtual Active Set• "M": Monitored Cells• "D": Detected Cells• "G": GSM cells• "U": UMTS cells• "NU": Non Ranked UMTS cells• "NG": Non Ranked GSM cells



Parameter	Type	Description		
<scrambling_code>	Number	Scrambling code; range 0-511		
<rscp_lev>	Number	Received Signal Code Power expressed in dBm levels. Range from 0 to 91.		
		0	RSCP < -115	dBm
		1	-115 = RSCP < -114	dBm
	
		90	-26 = RSCP < -25	dBm
		91	RSCP = -25	dBm
<ecn0_lev>	Number	Energy per Chip/Noise ratio expressed in dB levels. Range from 0 to 49.		
			ECN0 < -24	dB
		1	-24 = ECN0 < -23.5	dB
	
		48	-0.5 = ECN0 < 0	dB
		49	ECN0 = 0	
<gsm_band>	String	GSM band: <ul style="list-style-type: none"> "D": 1800 MHz "P": 1900 MHz "G": 900 MHz 		
<ranking_value>	Number	Cell's ranking value		
<ranking_status>	Number	Ranking status for Non Ranked UMTS cells. Possible values: <ul style="list-style-type: none"> 0: EM_CELL_SUITABLE 1: EM_NOT_MEASURED 2: EM_CELL_BARRED 3: EM_WRONG_PLMN 4: EM_HCS_CRITERIA_PRIO 5: EM_HCS_H_VALUE 6: EM_S_VALUE 		
<meas_id>	Number	RR measurement ID (one hex digit). For debug purpose only		
<event_id>	Number	Event ID (two hex digits). For debug purpose only		
<par 3,4,5...,M,...,N>	Number	Integer, range 0-99		
<signal_failure/radio_link_counter>	Number	Integer, range 0-99. For debug purpose only		
<reselection_reason>	Number	Indicates the reason for cell reselection. Possible values: <ul style="list-style-type: none"> 0: RESEL_PLMN_CHANGE 1: RESEL_SERV_CELL_NOT_SUITABLE 2: RESEL_BETTER_C2_C32 3: RESEL_DOWNLINK_FAIL 4: RESEL_RA_FAILURE 5: RESEL_SI_RECEIPT_FAILURE 6: RESEL_C1_LESS_NULL 7: RESEL_CALL_REEST_TIMEOUT 8: RESEL_ABNORMAL_RESEL 9: RESEL_CELL_CHANGE_ORDER 10: RESEL_NOT_OCCURRED 		
<dl_sc>/<ul_sc>	Number	Current burst configuration and Coding Scheme of downlink (<dl_sc>) or uplink (<ul_sc>) TBF may be: <ul style="list-style-type: none"> "NB_CS_1" "NB_CS_2" "NB_CS_3" "NB_CS_4" "NB_MCS_1" "NB_MCS_2" "NB_MCS_3" "NB_MCS_4" "NB_MCS_5" "NB_MCS_6" 		



Parameter	Type	Description
		<ul style="list-style-type: none"> • "NB_MCS_7" • "NB_MCS_8" • "NB_MCS_9" • "NB_MCS_5_7" • "NB_MCS_6_9" • "AB_8" • "AB_11" • "AB_11_E" • if none of the previous ""

UMTS/GSM MM parameters:

Parameter	Type	Description
<mm_state>	Number	MM state. For debug purpose only. Range 1-16
<mm_service_state>	Number	MM service state. For debug purpose only. Range 1-10.
<mm_update_status>	Number	location update status. For debug purpose only. Possible values: <ul style="list-style-type: none"> • 1: updated (MMST_U1_UPDATED) • 2: not updated (MMST_U2_NOT_UPDATED) • 3: roaming not allowed (MMST_U3_ROAMING_NOT_ALLOWED)
<ms_class>	String	MS GPRS-class. Possible values: <ul style="list-style-type: none"> • 0: class A • 1: class B • 2: class C • 3: class CG: class C in GPRS only mode • 4: class CC: class C in circuit switched only mode (lowest class)
<limited_service>	Number	Limited Service information. Possible values: <ul style="list-style-type: none"> • 0: no Limited service • 1: Limited Service
<ready_state>	Number	MM READY state. Possible values: <ul style="list-style-type: none"> • 0: not in ready state • 1: in ready state
<active_timer_bitmap>	Number	Bitmap of the active MM timers: T3302, T3310, T3311, T3312, T3314, T3321, T3330. T3302 is the least significant bit and T3330 the most significant bit The bitmap values are presented in hexadecimal format (the range goes from 0x0000 to 0x007F)
<cell_reselection_total>	Number	Total number of cell reselections. Range 0 - 65535.
<ir_cell_reselection_counter>	Number	Number of inter-rat cell reselections. Range 0 - 65535.
<attempted_ir_cell_reselection>	Number	Number of attempts of inter-rat cell reselections. Range 0 - 65535.
<ir_handover>	Number	Number of inter-rat handovers. Range 0 - 65535.
<attempted_ir_handover>	Number	Number of attempts of inter-rat handovers. Range 0 - 65535.

7.19.4 Notes

LISA-U

- <mode>=128, 129, 131, 132, 133 and 134 are not supported.
- the <details> parameter is not supported.

LISA-U2

- The SIM/PIN verification is needed.

LISA-U2x0-01S / LISA-U200-00S

- The set command can be issued when the response to the read command of +COPS AT command is 2.

SARA-G / LEON-G

- the <details> parameter is not supported.

**SARA-G / LEON-G100-06S**

- <mode>=128, 129, 131, 132, 133 and 134 are not supported.

7.20 Provide cell information +UCELLINFO

+UCELLINFO						
Modules	LISA-U SARA-U					
Attributes	Syntax	PIN required	Settings saved	Can be aborted	Response time	Error reference
	full	No	No	No	< 5 s	+CME Error

7.20.1 Description

Provides some information about the serving and neighbor cells (both for 2G RAT and 3G RAT). This information can be:

- Periodic
- One-shot

The periodic reporting about the network cells is performed enabling the URCs through the set command. If enabled, the URCs are periodically issued providing the status about the serving and neighbor cells.

The one-shot reporting about the network cells is performed issuing the read command.

7.20.2 Syntax

Type	Syntax	Response	Example
Set	AT+UCELLINFO=<mode>	OK	AT+UCELLINFO=1 OK
Read	AT+UCELLINFO?	Response syntax for 2G cells: +UCELLINFO: <mode>,<type>,<MCC>,<MNC>,<LAC>,<CI>,<RxLev>[,<t_adv>] OK Response syntax for 3G cells: +UCELLINFO: <mode>,<type>,<MCC>,<MNC>,<LAC>,<CI>,<scrambling_code>,<dl_frequency>,<rscp_lev>,<ecn0_lev> OK	
Test	AT+UCELLINFO=?	+UCELLINFO: (range of supported <mode>s) OK	+UCELLINFO: (0-2) OK
URC		URC syntax for 2G cells: +UCELLINFO: <mode>,<type>,<MCC>,<MNC>,<LAC>,<CI>,<RxLev>[,<t_adv>] URC syntax for 3G cells: +UCELLINFO: <mode>,<type>,<MCC>,<MNC>,<LAC>,<CI>,<scrambling_code>,<dl_frequency>,<rscp_lev>,<ecn0_lev>	

7.20.3 Defined values

Parameter	Type	Description
<mode>	Number	<ul style="list-style-type: none"> • 0: periodic reporting disabled • 1: periodic reporting enabled • 2: reserved
<type>	Number	For 2G cell: <ul style="list-style-type: none"> • 0: 2G serving cell • 1: neighbor 2G cell

Parameter	Type	Description
		For 3G cell: <ul style="list-style-type: none"> • 2: 3G serving cell or cell belonging to the Active Set • 3: cell belonging to the Virtual Active Set • 4: detected cell
<MCC>	Number	See +CGED command description; 0, 65535 are invalid values
<MNC>	Number	See +CGED command description; 0, 65535 are invalid values
<LAC>	Number	Location Area Code, range 0-0xFFFF; 0, 0xFFFF are invalid values
<CI>	Number	Cell ID, range 0-0xFFFF; 0, 0xFFFF are invalid values
<RxLev>	Number	Signal strength, see +CGED command description; 255 is an invalid value
<t_adv>	Number	Timing Advance, it is valid during a connection and it will be updated during the next connection; see 3GPP TS 04.18 [40]
<scrambling_code>	Number	See +CGED command description; values greater than 512 are invalid
<dl_frequency>	Number	See +CGED command description; 65535 is an invalid value
<rscp_lev>	Number	See +CGED command description; only valid for 3G cells; 255 is an invalid value
<ecn0_lev>	Number	See +CGED command description; only valid for 3G cells; 255 is an invalid value

7.20.4 Notes

- If the MT is 3G registered with an active radio connection (CELL_DCH):
 - <MCC>, <MNC>, <LAC> and <CI> will be always invalid for 3G cells belonging to Active Set, Virtual Active Set, Detected Set
 - The 3G serving cell data could be outdated. Use the Active Set data for any information regarding involved cells in the current radio connection

7.21 Lock on a specific cell +UCELLOCK

+UCELLOCK						
Modules	LEON-G100-07S LEON-G100-08S SARA-G340 SARA-G350 LISA-U200-02S LISA-U200-52S LISA-U200-62S LISA-U200-82S LISA-U260-02S LISA-U270-02S LISA-U270-62S SARA-U					
Attributes	Syntax	PIN required	Settings saved	Can be aborted	Response time	Error reference
	full	No	No	No	-	+CME Error

7.21.1 Description

Forces the module to lock on a:







- A specific GSM cell only (identified by its BCCH ARFCN)
- A specific UMTS cell only (identified by its UARFCN and PSC)
- A specific GSM or a specific UMTS cell

The feature can work in idle-mode only (basic lock: the reselections are inhibited) and in both idle and connected-mode (extended lock: both the reselections and the handovers are inhibited).

Based on the specified cell(s):

- **GSM only** (set the module in 2G mode with AT+URAT=0): the user only sets the ARFCN and the module enters a GSM only mode:
 - If any lock is set, the reselections are inhibited in idle-mode and if the specific BCCH ARFCN is not available, the module enters the Out Of Coverage (OOC) state
 - If the extended lock mode is set, the handovers are inhibited in connected-mode
 - Extended redirection lock mode is equivalent to the extended lock mode
- **UMTS only** (set the module in 3G mode with AT+URAT=2): the user only sets the UARFCN+PSC pair and the module enters a UMTS only mode. The reselections are inhibited and if the specific UARFCN and PSC are not available, the module enters the OOC state
 - In the normal lock mode the UE can leave the locked cell due to the handovers and the radio reconfiguration by the network



- o In the extended lock mode, the handovers are inhibited. The reconfiguration via redirection IEs is still allowed
 - o In extended redirection lock mode any reconfiguration via redirection IEs (see 3GPP 25.331) is rejected or ignored
 - **GSM and UMTS** (set the module in the automatic 2G/3G mode with AT+URAT=1,2 or AT+URAT=1,0): the user sets both the ARFCN and the UARFCN, PSC pair to make the module enter in dual mode. The module searches for any of the two locking cells and camps on the first cell found. Reselections in idle mode (and/or handovers in connected mode, in case of extended or extended redirection lock) are allowed to the other locking cell only
-  LEON-G / SARA-G
The UMTS and dual mode are not available.
-  The +COPS=5 command can be used to determine the available BCCH ARFCN / UARFCN and PSC numbers.
-  The set command can only be executed when the module is not registered and no registration attempt is in progress (+COPS set to 2).
-  If the +URAT mode is not compatible with the requested cell(s) type then the command will return an error.
-  If the +UCELLOCK is provided with an unsupported UARFCN then the command will return an error and the previous configuration will be restored unless the current +URAT mode is not compatible, in which case the cell lock will be disabled.
-  +COPS=5 and +COPS=? shall not be used when the lock is enabled, because the results would be inconsistent.

7.21.2 Syntax

Type	Syntax	Response	Example
Set	AT+UCELLOCK=<lock_mode>[,<BCCH_ARFCN>[,<band1900>[,<UARFCN>,<PSC>]]]	OK	AT+UCELLOCK=0 OK AT+UCELLOCK=2,90 OK AT+UCELLOCK=2,,10750,100 OK AT+UCELLOCK=2,700,1,10750,100 OK
Read	AT+UCELLOCK?	+UCELLOCK: [<lock_result>[,<locked_RAT>],]<lock_mode>[,<BCCH_ARFCN>,<band1900>[,<UARFCN>,<PSC>]] OK	+UCELLOCK: 1,2,90,0 OK
Test	AT+UCELLOCK=?	+UCELLOCK: (list of supported <lock>'s),(list of supported <BCCH_ARFCN>'s),(list of supported <band1900>'s),(list of supported <UARFCN>'s),(list of supported <PSC>'s) OK	+UCELLOCK: (0,2-5),(0-1023),(0,1),(1537-10838),(0-511) OK
URC		+UCELLOCK: <lock_result>[,<locked_RAT>]	

7.21.3 Defined values

Parameter	Type	Description
<lock_mode>	Number	Action configuration: <ul style="list-style-type: none"> • 0: lock disabled • 2: lock enabled without URC



Parameter	Type	Description
		<ul style="list-style-type: none"> • 3: lock enabled with URC • 4: extended lock enabled without URC • 5: extended lock enabled with URC • 6: extended redirection lock enabled without URC • 7: extended redirection lock enabled with URC
<BCCH_ARFCN>	Number	Indicates on which cell (BCCH ARFCN) to perform the lock (range 0-1023 if <band1900> is 0; 512-810 if <band1900> is 1). A value of 65535 is invalid and it is present in the read output if the ARFCN has not been set.
<band1900>	Number	Indicates whether the given <BCCH_ARFCN> is part of band 1900 or not, to avoid ambiguity between bands 1800 and 1900: <ul style="list-style-type: none"> • 0: (default value) the given <BCCH_ARFCN> is not part of band 1900 • 1: the given <BCCH_ARFCN> is part of band 1900
<UARFCN>	Number	Indicates the UARFCN to perform the lock on (range 1537-10838). A value of 65535 is invalid and it is present in the read output if the UARFCN has not been set. This parameter is equivalent to <dl_frequency> parameter in <i>+CGED</i> and <i>+UCCELLINFO</i> commands.
<PSC>	Number	Indicates the Primary Scrambling Code of the locked cell (range 0-511). A value of 65535 is invalid and it is present in the read output if the PSC has not been set.
<lock_result>	Number	Result of the last issued lock: <ul style="list-style-type: none"> • 1: lock enabled and successful, camped on the requested cell • 2: lock enabled but unsuccessful, the requested cell was not found
<locked_RAT>	Number	Current locked RAT: <ul style="list-style-type: none"> • 1: GSM • 2: UMTS

7.21.4 Notes

- If <lock_mode>=0, the <BCCH_ARFCN>, <band1900>, <UARFCN> and <PSC> parameters are not used.
- If <lock_mode> differs from 0, the <BCCH_ARFCN>, <UARFCN> and <PSC> parameters are mandatory.
- If <band1900> is issued, <BCCH_ARFCN> is mandatory.
- The printed list of supported <UARFCN> reports only the theoretical minimum and maximum UARFCN for readability sake. The supported band ranges and additional frequencies are product dependent. The supported UARFCN list is the following (based on 3GPP 25.101 ch 5.4.4 - Table 5.2):

Operating band	Frequency band	Min UARFCN	Max UARFCN	Additional UARFCNs
Band I	2100	10562	10838	-
Band II	1900	9662	9938	412, 437, 462, 487, 512, 537, 562, 587, 612, 637, 662, 687
Band IV	1700	1537	1738	1887, 1912, 1937, 1962, 1987, 2012, 2037, 2062, 2087
Band V	850	4357	4458	1007, 1012, 1032, 1037, 1087
Band VI	800	4387	4413	1037, 1062
Band VII	900	2937	3088	-

Table 2: Supported UARFCN list

- If <lock_mode>=0, the read command's response only displays <lock_mode>.
- If <lock_result>=2, then the module is in OOC state and will persist in such state until <lock_mode>=0 is set or the specific GSM and/or UMTS cell(s) are found.
- If <lock_result>=2 and if the lock has been set on both a GSM and UMTS cell then the <locked_RAT> is meaningless and should not be considered

LEON-G / SARA-G

- <lock_mode>=6, <lock_mode>=7, <locked_RAT>, <UARFCN>, <PSC> are not supported.

7.22 Wireless service selection +WS46

+WS46						
Modules	LISA-U SARA-U					
Attributes	Syntax	PIN required	Settings saved	Can be aborted	Response time	Error reference
	full	No	No	No	-	+CME Error

7.22.1 Description

Select the cellular service (Wireless Data Service; WDS) to operate with the MT according to PCCA STD-101 [86]. PCCA calls the WDS-Side Stack Selection. The command may be used when the MT is asked to indicate the wireless services in which it can operate.



u-blox cellular modules are certified according to all the capabilities and options stated in the Protocol Implementation Conformance Statement document (PICS) of the module. The PICS, according to 3GPP TS 51.010-2 [83] and 3GPP TS 34.121-2 [84], is a statement of the implemented and supported capabilities and options of a device. If the user changes the command settings during the certification process, the PICS of the application device integrating a u-blox cellular module must be changed accordingly.

7.22.2 Syntax

Type	Syntax	Response	Example
Set	AT+WS46=<n>	OK	AT+WS46=25 OK
Read	AT+WS46?	+WS46: <n> OK	+WS46: 25 OK
Test	AT+WS46=?	+WS46: (list of supported <n>s) OK	+WS46: (12,22,25) OK

7.22.3 Defined values

Parameter	Type	Description
<n>	Number	WDS-Side stack selection indication and may be: <ul style="list-style-type: none"> • 12: GSM digital cellular (single mode GSM) • 22: UTRAN only (single mode UMTS) • 25 (factory-programmed value): 3GPP systems, both GERAN and UTRAN (dual mode stack)

7.22.4 Notes

- It is possible to configure the WDS-Side stack only when is not registered on the wireless service.
- The +URAT command provides extended functionalities with respect to +WS46 command.

7.23 Home zone reporting +UHOMEZR

+UHOMEZR						
Modules	LISA-U SARA-U					
Attributes	Syntax	PIN required	Settings saved	Can be aborted	Response time	Error reference
	full	No	No	No	-	+CME Error

7.23.1 Description

The set command enables and disables home zone change event reporting. If reporting is enabled, the MT returns URC +UHOMEZR: <label> whenever the home zone is changed.

7.23.2 Syntax

Type	Syntax	Response	Example
Set	AT+UHOMEZR=<onoff>	OK	AT+UHOMEZR=1

Type	Syntax	Response	Example
Read	AT+UHOMEZR?	+UHOMEZR: <onoff> OK	OK
Test	AT+UHOMEZR=?	+UHOMEZR: (list of supported <onoff>s) OK	+UHOMEZR: (0-1) OK
URC		+UHOMEZR: <label>	

7.23.3 Defined values

Parameter	Type	Description
<onoff>	Number	<ul style="list-style-type: none"> 0 (default value): disable home zone change event reporting 1: enable home zone change event reporting
<label>	String	Zone label indication <ul style="list-style-type: none"> "HOME": also possible as "home", dependent from network indication "CITY": zone label

7.24 Jamming Detection +UCD

+UCD						
Modules	LEON-G SARA-G340 SARA-G350 LISA-U SARA-U					
Attributes	Syntax	PIN required	Settings saved	Can be aborted	Response time	Error reference
	partial	Yes	No	No	-	+CME Error

7.24.1 Description

The feature consists in detecting, at radio resource level, an anomalous source of interference and signalling it to the client. The jamming condition occurs when simultaneously:

- The synchronization is lost (i.e. the MT is no longer camped on the serving cell and cannot select any other suitable cell)
- An interference is detected (i.e. the band scan reveals at least n carriers, with power level equal or higher than a specified threshold, on which no synchronization is possible)

If <mode> is set to 5, 6 and 7 an additional constraint to verify a jamming condition occurrence is added:

- The synchronization is lost and the MT cannot select any other suitable cell of the "user-desired" PLMN. If the synchronization is lost due to the detected interference, and the MT camps and/or registers on a different PLMN, the jamming condition is not cleared as long as the "user-desired" PLMN is not detected or second condition (interference detected) is no longer true.

 LEON-G / SARA-G

the "user-desired" PLMN is implicitly defined as:

- The manually selected PLMN (i.e. the <oper> parameter, of +COPS=1,<format>,<oper>), when +COPS=1 is used. After enabling the advanced 2G jamming detection, +COPS=0 must be used to switch back to the automatic network selection.
- The Home PLMN (as read from the IMSI), when +COPS=0 is used

The jamming condition is cleared when any of the above mentioned statements does not hold.

The command configures how jamming is reported. If activated, an unsolicited indication is issued when the jamming condition is entered or released. In particular, the set command configures the URC **+UCD: <active>**.

 LEON-G100-06S / SARA-G / LISA-U1 / LISA-U2x0-01S
<desired_PLMN> is not supported.

 <mode>=2 returns the <active> value, if and only if the URC has been previously enabled. Otherwise the "Operation not allowed" error (see [Appendix A.7](#) for error codes) is generated.



<mode>=2 does not change the stored <mode> value.

When using <mode>=2 in the set command, the remaining parameters are not mandatory.

7.24.2 Syntax

Type	Syntax	Response	Example
Set	AT+UCD=<mode>[,<min_number_of_2G_carriers>,<rxlev_threshold>,<min_number_of_3G_carriers>,<rssi_threshold>[,<desired_PLMN>]]	[+UCD: <active>] OK	AT+UCD=3,,10,20 OK AT+UCD=2 +UCD: 1 OK
Read	AT+UCD?	if <mode>=1 or <mode>=5 (on SARA-G3) +UCD: <mode>,<min_number_of_2G_carriers>,<rxlev_threshold> OK if <mode>=3 +UCD: <mode>,,,<min_number_of_3G_carriers>,<rssi_threshold> OK if <mode>=4 +UCD: <mode>,<min_number_of_2G_carriers>,<rxlev_threshold>,<min_number_of_3G_carriers>,<rssi_threshold> OK if <mode>=5 +UCD: <mode>,<min_number_of_2G_carriers>,<rxlev_threshold>,<desired_PLMN> OK if <mode>=6 +UCD: <mode>,,,<min_number_of_3G_carriers>,<rssi_threshold>,<desired_PLMN> OK if <mode>=7 +UCD: <mode>,<min_number_of_2G_carriers>,<rxlev_threshold>,<min_number_of_3G_carriers>,<rssi_threshold>,<desired_PLMN> OK	+UCD: 1,10,20 OK +UCD: 3,,,11,25 OK +UCD: 4,10,20,11,25 OK +UCD: 5,10,20,"00115" OK +UCD: 6,,,11,25,"22269" OK +UCD: 7,10,20,11,25,"310456" OK
Test	AT+UCD=?	+UCD: (range of supported <mode>), (range of supported <min_number_of_2G_carriers>),(range of supported <rxlev_threshold>)[,(range of supported <min_number_of_3G_carriers>),(range of supported <rssi_threshold>)]<desired_PLMN>]] OK	+UCD: (0-4),(1-172),(3-63),(1-136),(0-76) OK
URC		+UCD: <active>	+UCD: 3



7.24.3 Defined values

Parameter	Type	Description
<mode>	Number	Mode of operation of the jamming detection. When enabled, the +UCDURC may be generated: <ul style="list-style-type: none">• 0: disabled• 1: 2G jamming detection enabled• 2: interrogation of the <active> value• 3: 3G jamming detection enabled• 4: 2G and 3G jamming detection enabled• 5: advanced 2G jamming detection enabled• 6: advanced 3G jamming detection enabled• 7: advanced 2G and 3G jamming detection enabled
<min_number_of_2G_carriers>	Number	Number of minimum disturbing carriers Mandatory parameter if <mode>=1 or <mode>=4 or <mode>=5; if <mode>=2 or <mode>=3 the parameter must be omitted <ul style="list-style-type: none">• Range between 1 and 172
<rxlev_threshold>	Number	Power level threshold for 2G carriers; refer to 3GPP TS 05.08 [28] Mandatory parameter if <mode>=1 or <mode>=4 or <mode>=5; if <mode>=2 or <mode>=3 the parameter must be omitted <ul style="list-style-type: none">• Range between 3 to 63
<min_number_of_3G_carriers>	Number	Number of minimum disturbing carriers Mandatory parameter if <mode>=3 or <mode>=4 or <mode>=6 or <mode>=7; if <mode>=0 or <mode>=1 or <mode>=2 or <mode>=5 the parameter must be omitted <ul style="list-style-type: none">• Range between 1 and 136
<rsssi_threshold>	Number	Power level threshold for 3G carriers Mandatory parameter if <mode>=3 or <mode>=4 or <mode>=6 or <mode>=7; if <mode>=0 or <mode>=1 or <mode>=2 or <mode>=5 the parameter must be omitted <ul style="list-style-type: none">• Range between 0 and 76
<desired_PLMN>	String	"user-desired" PLMN in numeric format (MCC and MNC).
<active>	Number	Jamming detection status: <ul style="list-style-type: none">• 0: 2G jamming no longer detected• 1: detected the 2G jamming• 2: 3G jamming no longer detected• 3: detected the 3G jamming

7.24.4 Notes

LISA-U

- The <active> value is not provided in the response to the set command.
- The jamming detection can be enabled / disabled only on one AT interface at a time. Once disabled on that AT interface, it can be enabled on a different one.
- The jamming detection can be independently enabled / disabled on 2G and 3G network.

LISA-U1 / LISA-U2x0-01S / LISA-U200-00S

- <mode>=5, <mode>=6 and <mode>=7 are not supported.

LEON-G / SARA-G

- <mode>=3, <mode>=4, <mode>=6 and <mode>=7 are not supported (thus <min_number_of_3G_carriers>, <rsssi_threshold> are also not present).
- The range of <min_number_of_2G_carriers> parameter is between 1 and 255.

8. Security

8.1 Enter PIN +CPIN

+CPIN						
Modules	LEON-G SARA-G					
	LISA-U SARA-U					
Attributes	Syntax	PIN required	Settings saved	Can be aborted	Response time	Error reference
	full	No	No	No	< 10 s	+CME Error

8.1.1 Description

Enter PIN. If no PIN request is pending, the corresponding error code is returned. If a wrong PIN is given three times, the PUK must be inserted in place of the PIN, followed by the <newpin> which replaces the old pin in the SIM.

8.1.2 Syntax

Type	Syntax	Response	Example
Set	AT+CPIN=<pin>[,<newpin>]	OK	AT+CPIN="0933" OK
Read	AT+CPIN?	+CPIN: <code> OK	+CPIN: SIM PIN OK
Test	AT+CPIN=?	OK	

8.1.3 Defined values

Parameter	Type	Description
<pin>, <newpin>	String	4-to-8 characters long string of decimal digits. If only PIN is required, <newpin> is not to be entered. If PUK is required, <pin> must be the PUK and <newpin>, the new PIN code, must be entered as well.
<code>	String	<ul style="list-style-type: none"> READY: MT is not pending for any password SIM PIN: MT is waiting SIM PIN to be given SIM PUK: MT is waiting SIM PUK to be given SIM PIN2: MT is waiting SIM PIN2 to be given SIM PUK2: MT is waiting SIM PUK2 to be given PH-NET PIN: MT is waiting network personalization password to be given PH-NETSUB PIN: MT is waiting network subset personalization password to be given PH-SP PIN: MT is waiting service provider personalization password to be given PH-CORP PIN: MT is waiting corporate personalization password to be given PH-SIM PIN: MT is waiting phone to SIM/UICC card password to be given

8.1.4 Notes

- The command needs the SIM module to work correctly
- If PIN is not inserted the following situation can occur:

AT+CMEE=2

OK

AT+COPS=0

+CME ERROR: SIM PIN required

AT+CMEE=0

OK

AT+COPS=0

ERROR

- To change the PIN the user must use the AT+CPWD="SC",<old_pin>,<new_pin> command (see [Chapter 8.4](#) for details).

Example:

AT+CPWD="SC","1234","4321"

8.2 Read remaining SIM PIN attempts +UPINCNT

+UPINCNT						
Modules	LEON-G SARA-G					
	LISA-U SARA-U					
Attributes	Syntax	PIN required	Settings saved	Can be aborted	Response time	Error reference
	full	No	No	No	-	+CME Error

8.2.1 Description

Reads the remaining attempts for SIM PIN, SIM PIN2, SIM PUK and SIM PUK2.

8.2.2 Syntax

Type	Syntax	Response	Example
Action	AT+UPINCNT	+UPINCNT: <PIN attempts>, <PIN2 attempts>, <PUK attempts>, <PUK2 attempts> OK	+UPINCNT: 3,3,10,10 OK
Test	AT+UPINCNT=?	OK	OK

8.2.3 Defined values

Parameter	Type	Description
<PIN attempts>	Number	Number of remaining attempts to enter PIN
<PIN2 attempts>	Number	Number of remaining attempts to enter PIN2
<PUK attempts>	Number	Number of remaining attempts to enter PUK
<PUK2 attempts>	Number	Number of remaining attempts to enter PUK2

8.3 Facility lock +CLCK

+CLCK						
Modules	LEON-G SARA-G					
	LISA-U SARA-U					
Attributes	Syntax	PIN required	Settings saved	Can be aborted	Response time	Error reference
	full	Yes	No	Yes	Up to 3 min	+CME Error

8.3.1 Description

Used to lock, unlock or interrogate an MT or a network facility <fac>. A password is normally needed to do such actions. When querying the status of a network service (<mode>=2) the response line for "not active" case (<status>=0) should be returned only if the service is not active for any <class>. The command is abortable if network facilities are set or interrogated.

 For <fac> "PN", "PU", "PP", "PC" and "PS" only <mode>=0 and <mode>=2 (unlock and query status) are always supported.

 For <fac> "PN", "PU", "PP", "PC" and "PS" <mode>=1 (lock status) is supported only if proper re-activation characteristic is enabled during personalization.

8.3.2 Syntax

Type	Syntax	Response	Example
Set	AT+CLCK=<fac>,<mode>[,<passwd>[,<class>]]	OK or +CLCK: <status>[,<class1> [+CLCK: <status>[,<class1> [...]]	AT+CLCK="SC",1,"0933" OK
Test	AT+CLCK=?	+CLCK: (list of supported <fac>s) OK	+CLCK: ("SC","PN","PU","PP","PC", "PS","FD","AO","OI","OX","AI","IR", "AB","AG","AC") OK

8.3.3 Defined values

Parameter	Type	Description
<fac>	String	Facility values <ul style="list-style-type: none"> • "SC": SIM (lock SIM card) • "PN": Network Personalisation (refer to 3GPP TS 22.022 [31]) • "PU": network sUbset Personalisation (refer to 3GPP TS 22.022 [31]) • "PP": service Provider Personalisation (refer to 3GPP TS 22.022 [31]) • "PC": Corporate Personalisation (refer to 3GPP TS 22.022 [31]) • "PS": SIM/USIM Personalisation (refer to 3GPP TS 22.022 [31]) • "FD": SIM fixed dialling phonebook feature (if PIN2 authentication has not been done during the current session, PIN2 is required as <passwd>) • "AO": BAR (Bar All Outgoing Calls) • "OI": BOIC (Bar Outgoing International Calls) • "OX": BOIC-exHC(Bar Outgoing International Calls except to Home Country) • "AI": BAIC (Bar All Incoming Calls) • "IR": BIC-Roam (Bar Incoming Calls when Roaming outside the home country) • "AB": All Barring services (applicable only for <mode>=0) • "AG": All outGoing barring services (applicable only for <mode>=0) • "AC": All inComing barring services (applicable only for <mode>=0)
<mode>	Number	<ul style="list-style-type: none"> • 0: unlock • 1: lock • 2: query status
<status>	Number	<ul style="list-style-type: none"> • 0: not active • 1: active
<passwd>	String	Shall be the same as password specified for the facility from the MT user interface or with command +CPWD (for more details refer to Chapter 8.4)
<class>	Number	Sum of numbers each representing a class of information. Default value is 7 (voice + data + fax) <ul style="list-style-type: none"> • 1: voice • 2: data • 4: FAX • 8: short message service • 16: data circuit sync • 32: data circuit async • 64: dedicated packet access • 128: dedicated PAD access

8.4 Change password +CPWD

+CPWD						
Modules	LEON-G SARA-G					
	LISA-U SARA-U					
Attributes	Syntax	PIN required	Settings saved	Can be aborted	Response time	Error reference
	full	No	No	Yes	<i>Up to 3 min</i>	<i>+CME Error</i>

8.4.1 Description

Sets a new password for the facility lock function defined by command +CLCK. The command is abortable if a character is sent to DCE during the command execution.

8.4.2 Syntax

Type	Syntax	Response	Example
Set	AT+CPWD=<fac>,<oldpwd>, <newpwd>	OK	AT+CPWD="SC","0933","0934" OK
Test	AT+CPWD=?	+CPWD: list of available (<fac>,<pwdlength>s) OK	+CPWD: ("SC",8),("P2",8),("AO",4),("OI",4),("OX",4),("AI",4),("IR",4),("AB",4),("AG",4),("AC",4) OK

8.4.3 Defined values

Parameter	Type	Description
<fac>	String	"P2" SIM PIN2; refer to Facility Lock +CLCK (Chapter 8.3.3) for other values
<oldpwd>	String	Old password
<newpwd>	String	New password
<pwdlength>	Number	Length of password (digits)

8.4.4 Notes

- If the PIN is blocked, an error message will be provided when attempting to change the PIN code if the PIN check is disabled through AT+CLCK.

8.5 Custom SIM lock +USIMLCK

+USIMLCK						
Modules	LEON-G SARA-G					
	LISA-U SARA-U					
Attributes	Syntax	PIN required	Settings saved	Can be aborted	Response time	Error reference
	full	No	No	No	-	<i>+CME Error</i>

8.5.1 Description

Allows locking the module to work only with user-defined sets of SIM cards (e.g. a subset of networks, with a specified SIM card). According to the 3GPP TS 22.022 [31] there are different kinds of lock as follows:

- Network
- Network Subset
- SIM
- Service Provider (not supported)
- Corporate (not supported)

The module is locked according to user needs even if the SIM card is not inserted or the PIN code is not provided. At most 10 personalizations can be simultaneously configured.

8.5.2 Syntax

Type	Syntax	Response	Example
Set	AT+USIMLCK=<facility>,<pers_data>,<pwd>,<status>	OK	AT+USIMLCK="PN","222.01", "12345678",1 OK
Test	AT+USIMLCK=?	+USIMLCK: (list of supported <facility>s), ,(list of supported <status>) OK	+USIMLCK: ("PN","PU","PS"),,(0-1) OK

8.5.3 Defined values

Parameter	Type	Description
<facility>	String	Personalization type, which can be: <ul style="list-style-type: none"> "PN" Network personalization "PU" Networks subset personalization "PS" SIM/USIM personalization
<pers_data>	String	Data for device personalization. The contents depend on the selected <facility>. <ul style="list-style-type: none"> If <facility> is "PN": <pers_data> is in the format: "MCC1.MNC1min[-MNC2max][,MCC2.MNC2min[-MNC2max]... [,MCC10.MNC10min[-MNC10max]]" It contains a list of comma-separated pairs of MCCs and MNC ranges If <facility> is "PU": <pers_data> is in the format: "MCC1.MNC1min[-MNC2max][,MCC2.MNC2min[-MNC2max]... [,MCC10.MNC10min[-MNC10max]]:MSIN1[,MSIN2...[,MSIN10]]" It contains a list of comma-separated pairs of MCCs+MNC ranges as above; a list of comma-separated MSIN(s) or ranges of MSINs is appended after the MCC/MNC range using a ':' as separator. MSINs can be written with wildcards (*) with the syntax: [*[*]D1[D2[...]]] (one wildcard for each MSIN digit to skip) followed by one or more digits. It is possible to use ranges of MSIN digits; in this case the minimum and maximum values should have the same number of wildcard and the same number of digits. In addition it is possible to concatenate more MSIN ranges with the comma separator (example: "123.456:56,**70-**72"). In this case all ranges must create a non empty set since MSIN comma separator behavior is an AND operator: an empty set means that any SIM is accepted If <facility> is "PS": <pers_data> contains a list of at most 10 IMSIs; the format of the string is: "IMS1:IMS2:...:IMS1n" <div style="margin-left: 20px;">  LEON-G1 / SARA-G3 / LISA-U200-00S <ul style="list-style-type: none"> If <facility> is "PN": <pers_data> contains at most 10 pairs of MCC and MNC in the following format: "MCC.MNC" separated by colon: "MCC1.MNC1:MCC2.MNC2:...:MCCn.MNCn" If <facility> is "PU": <pers_data> contains MCC + MNC + a list of at most 10 pairs of the digits 6 and 7 of IMSI; the format of the string is: "MCC.MNC:DD1:DD2:...:DDn" where DDx represent the sixth and seventh digits of IMSI If <facility> is "PS": <pers_data> contains a list of at most 10 IMSIs; the format of the string is: "IMS1:IMS2:...:IMS1n" </div>
<pwd>	String	Password to enable/disable the personalization. The password length goes from 6 to 16 digits
<status>	Number	<ul style="list-style-type: none"> 0: feature set but disabled 1: feature set and enabled



8.5.4 Notes

- The current personalization status can be queried using the AT+CLCK command with the proper facilities <fac> and the query status mode <mode>=2.
- At the end of command execution, the module is deregistered from network, reset and rebooted.
- A maximum of 5 attempts are allowed in case a wrong password is inserted during an unlock operation with +CLCK command; after that, further unlock operations are blocked. The ME can still be used with the right SIM.
- The following error messages could be provided
 - o "+CME ERROR: invalid characters in text string" (error code: 25): an error is present in the <pers_data> format
 - o "+CME ERROR: operation not allowed" (error code: 3): the user attempted the module personalization with an already active facility. An unlock operation must be performed before. Alternatively, an internal driver error occurred.
 - o "+CME ERROR: incorrect password" (error code: 16): The password format or length is wrong
- If the SIM lock is disabled it is possible to enable the lock with AT+CLCK command providing needed parameters (<fac>, <mode>=1 and the password); otherwise the same personalization type can be modified at any time by means of AT+USIMLCK command.
- If the SIM lock is enabled the same personalization can be modified only if before it has been disabled through AT+CLCK command.

9. Phonebook

9.1 Select phonebook memory storage +CPBS

+CPBS						
Modules	LEON-G SARA-G340 SARA-G350					
	LISA-U SARA-U					
Attributes	Syntax	PIN required	Settings saved	Can be aborted	Response time	Error reference
	full	Yes	No	No	< 35 s	+CME Error

9.1.1 Description

Selects a phonebook memory storage for further use in phonebook related commands.



The response to the test command depends on SIM dependent parameters (e.g. "EC").

9.1.2 Syntax

Type	Syntax	Response	Example
Set	AT+CPBS=<storage>[,<password>]	OK	AT+CPBS="SM" OK
Read	AT+CPBS?	+CPBS: <storage>[,<used>,<total>] OK	+CPBS: "SM",25,150 OK
Test	AT+CPBS=?	+CPBS: (list of supported <storages>s) OK	+CPBS: ("SM","FD","LD","SN","EC", "ON","BL") OK

9.1.3 Defined values

Parameter	Type	Description
<storage>	String	Phonebook memory storage; the following values are allowed: <ul style="list-style-type: none"> "SM": SIM phonebook (depending on SIM card, it may not be available when FDN is enabled) "FD": SIM fixed dialling phonebook (only valid with PIN2) "LD": SIM last-dialling phonebook "BN": SIM barred-dialling-number phonebook (only valid with PIN2) "SN": SIM service-dialling-number phonebook (read only) "EC": SIM emergency-call-codes phonebook (read only) "ON": Own number phone-book (read/write); content is also shown by +CNUM "BL": Blacklist phonebook (delete only); only the position 0 is valid
<password>	String	PIN2-code required when selecting PIN2-code <storage>s above (e.g. "FD"), if PIN2 is applicable
<used>	Number	Indicates the number of used locations in selected memory
<total>	Number	Indicates the total number of locations in selected memory

9.2 Read phonebook entries +CPBR

+CPBR						
Modules	LEON-G SARA-G340 SARA-G350					
	LISA-U SARA-U					
Attributes	Syntax	PIN required	Settings saved	Can be aborted	Response time	Error reference
	partial	Yes	No	No	< 35 s	+CME Error

9.2.1 Description

Returns phonebook entries in location number range <index1> ... <index2> from the current phonebook memory storage selected with +CPBS. If <index2> is left out, only location <index1> is returned. Entry fields returned are:

- location number <indexn>
- phone number stored there <number> of format <type>
- text <text> associated with the number
- <group> indicating a group the entry may belong to (if the selected phonebook supports it)
- <adnumber> an additional number (of format <adtype>) (if the selected phonebook supports it)
- <secondtext> a second text field associated with the number (if the selected phonebook supports it)
- <email> an email field (if the selected phonebook supports it)

No text lines are returned for empty (but available) locations.

 The wildcard character (?) in the phone number of FDN is allowed.

9.2.2 Syntax

Type	Syntax	Response	Example
Set	AT+CPBR=<index1>[,<index2>]	[+CPBR: <index1>,<number>,<type>,<text>[,<group>[,<adnumber>[,<adtype>[,<secondtext>[,<email>]]]]]] [...] [+CPBR: <index2>,<number>,<type>,<text>[,<group>[,<adnumber>[,<adtype>[,<secondtext>[,<email>]]]]]]	AT+CPBR=1,4 +CPBR: 1,"040123456",129,"RossiCarlo" +CPBR: 2,"040123457",129,"RossiMario" +CPBR: 4,"040123458",129,"RossiGiuseppe"
Test	AT+CPBR=?	+CPBR: (list of supported <index>s),<nlength>,<tlength>[,<glength>[,<alength>[,<slength>[,<elength>]]]] OK	+CPBR: (1-100),20,18 OK

9.2.3 Defined values

Parameter	Type	Description
<index1>, <index2>,<index>	Number	Range of location numbers of phonebook memory
<number>	String	Phone number of format <type>
<type>	Number	Type of address octet (refer to 3GPP TS 24.008 [30] subclause 10.5.4.7)
<text>	String	Text associated with the phone number of maximum length <tlength>
<group>	String	Group the phonebook entry may belong to, of maximum length <glength>
<adnumber>	String	Additional phone number of format <adtype>
<adtype>	Number	Type of address octet (refer to 3GPP TS 24.008 [30] subclause 10.5.4.7)
<secondtext>	String	Second text associated with the number, of maximum length <slength>
<email>	String	Email of maximum length <elength>
<nlength>	Number	Maximum length of field <number>
<tlength>	Number	Maximum length of field <text>
<glength>	Number	Maximum length of field <group>
<alength>	Number	Maximum length of field <adnumber>
<slength>	Number	Maximum length of field <secondtext>
<elength>	Number	Maximum length of field <email>

9.2.4 Notes

LEON-G / SARA-G340 / SARA-G350

- <group>, <adnumber>, <adtype>, <secondtext>, <email>, <glength>, <alength>, <slength>, <elength> are not supported.

9.3 Find phonebook entries +CPBF

+CPBF						
Modules	LEON-G SARA-G340 SARA-G350 LISA-U SARA-U					
Attributes	Syntax	PIN required	Settings saved	Can be aborted	Response time	Error reference
	partial	Yes	No	No	< 35 s	+CME Error

9.3.1 Description

Returns the phonebook entries from the current phonebook memory storage (previously selected by +CPBS), whose alphanumeric field <text> starts with string <findtext>.

Entry fields returned are:

- location number <indexn>
- phone number stored there <number> of format <type>
- text <text> associated with the number
- <group> indicating a group the entry may belong to (if the selected phonebook supports it)
- <adnumber> an additional number (of format <adtype>) (if the selected phonebook supports it)
- <secondtext> a second text field associated with the number (if the selected phonebook supports it)
- <email> an email field (if the selected phonebook supports it)



The string <findtext> is case sensitive.

9.3.2 Syntax

Type	Syntax	Response	Example
Set	AT+CPBF=<findtext>	[+CPBF: <index1>,<number>,<type>,<text>[,<group>[,<adnumber>[,<adtype>[,<secondtext>[,<email>]]]]] [...] [+CPBF: <index2>,<number>,<type>,<text>[,<group>[,<adnumber>[,<adtype>[,<secondtext>[,<email>]]]]] OK	AT+CPBF="u-blox" OK
Test	AT+CPBF=?	+CPBF: [<nlength>],[<tlength>],[<glength>[,<alength>[,<slength>[,<elength>]]]] OK	+CPBF: 40,18 OK

9.3.3 Defined values

Parameter	Type	Description
<index1>, <index2>, <index>	Number	Location numbers of phonebook memory
<number>	String	Phone number of format <type>
<type>	Number	Type of address octet (refer to 3GPP TS 24.008 subclause 10.5.4.7)
<findtext>,<text>	String	Maximum length <tlength>
<group>	String	Group the phonebook entry may belong to, of maximum length <glength>
<adnumber>	String	Additional phone number of format <adtype>
<adtype>	Number	Type of address octet (refer to 3GPP TS 24.008 subclause 10.5.4.7)
<secondtext>	String	Second text associated with the number, of maximum length <slength>
<email>	String	Email of maximum length <elength>
<nlength>	Number	Maximum length of field <number>
<tlength>	Number	Maximum length of field <text>
<glength>	Number	Maximum length of field <group>
<alength>	Number	Maximum length of field <adnumber>
<slength>	Number	Maximum length of field <secondtext>

Parameter	Type	Description
<elength>	Number	Maximum length of field <email>

9.3.4 Notes

LEON-G / SARA-G340 / SARA-G350

- <group>, <adnumber>, <adtype>, <secondtext>, <email>, <glength>, <alength>, <slength>, <elength> are not supported.

9.4 Write phonebook entry +CPBW

+CPBW						
Modules	LEON-G SARA-G340 SARA-G350					
	LISA-U SARA-U					
Attributes	Syntax	PIN required	Settings saved	Can be aborted	Response time	Error reference
	partial	Yes	No	No	< 35 s	+CME Error

9.4.1 Description

Stores phonebook entry in the current phonebook memory storage (selectable with +CPBS) at the location specified by the <index> field. Other entry fields are:

- the phone number <number> (in the <type> format)
- <text> text associated with the number
- <group> indicating a group the entry may belong to
- <adnumber> an additional number (of format <adtype>)
- <secondtext> a second text field associated with the number
- <email> an email field

If all the fields are omitted, except for <index>, the corresponding phonebook entry is deleted. If the <index> field is left out, but the <number> is given, the entry is written in the first free location in the current phonebook memory storage.

If no phonebook entries are available the response to the test command will be +CPBW: 0 <CR><LF>OK



The (?) wildcard character in the phone number is allowed in the FD phonebook only.



<group>, <adnumber>, <adtype>, <secondtext>, <email> parameters are not supported by 2G SIM; but they could be supported by USIM. Not all the fields are always supported on the used USIM: to verify which fields are supported refer to the test command.



In case of previously selected BL blacklist phonebook, no parameters are needed; <index>=0 is also accepted.



The set command +CPBW is not applicable for the storages "SN", "EC" (read only storages), while it is applicable to "LD" storage only to delete an item.

9.4.2 Syntax

Type	Syntax	Response	Example
Set	AT+CPBW=[<index>][,<number> [,<type>[,<text>[,<group>[,<adnumber>[,<adtype>[,<secondtext>[,<email>]]]]]]]]	OK	AT+CPBW=5,"091137880",,"u-blox" OK
Test	AT+CPBW=?	+CPBW: (list of supported <index>s), <nlength>,(list of supported <type>s), <tlength>[,<glength>[,<alength>[,<slength>[,<elength>]]]]]]] OK or +CPBW: 0	+CPBW: (1-250),40,(129,145),18 OK



Type	Syntax	Response	Example
		OK	

9.4.3 Defined values

Parameter	Type	Description
<index>	Number	Location numbers of phonebook memory
<number>	String	Phone number of format <type>
<type>	Number	Type of address; default is 145 when dialling string includes '+', otherwise 129
<text>	String	Maximum length <tlength>
<group>	String	Group the phonebook entry may belong to, of maximum length <glength>
<adnumber>	String	Additional phone number of format <adtype>
<adtype>	Number	Type of address; default is 145 when dialling string includes '+', otherwise 129
<secondtext>	String	Second text associated with the number, of maximum length <slength>
<email>	String	Email of maximum length <elength>
<nlength>	Number	Maximum length of field <number>
<tlength>	Number	Maximum length of field <text>
<glength>	Number	Maximum length of field <group>
<alength>	Number	Maximum length of field <adnumber>
<slength>	Number	Maximum length of field <secondtext>
<elength>	Number	Maximum length of field <email>

9.4.4 Notes

LEON-G / SARA-G340 / SARA-G350

- <group>, <adnumber>, <adtype>, <secondtext>, <email> parameters are not supported.

10. Short Messages Service

10.1 Introduction

In case of errors all the SMS related AT commands return the result codes defined in [Appendix A.8](#) instead of the usual error result codes listed in [Appendix A.7](#).

Parameter <index> description for ME (ME message), SM ((U)SIM message) and MT (ME + SM) memory cases:

- 0: SMS class 0 stored in RAM (the last one received).
- Values between 1 and 300: SMS stored in the ME message storage.
- Values between 301 and (301 + (n-1)): SMS stored in the SIM (n depends on the SIM card used).



SARA-G300 / SARA-G310

The <index> parameter the range goes from 1 to n (n depends on the SIM Card used) and represents the index of SMS stored in the SIM.

Parameter <index> description for BM (Broadcast Message) memory case:

- LISA-U / SARA-U series - Values between 1 and 300: Cell Broadcast messages are stored only if there is at least an empty location available in the BM memory (that is located in the file system)
- LEON-G / SARA-G series - Values between 1 and 5: Cell Broadcast messages are stored using a circular buffer so they are always saved even if the BM memory (that is located in RAM) is full. Since the Cell Broadcast messages are stored in RAM, they will be lost after a power-off or reset of the module.

Parameter <index> description for SR (status Report) memory case:

- Values between 1 and 300 (LISA-U / SARA-U series): Status Report messages are stored only if there is at least an empty location available in the SR memory (that is located in the file system).

The following limitations apply related to the SMS usage:

Single SMS

- 160 characters if <dc> = "GSM 7 bit default alphabet data"
- 140 octets if <dc> = "8-bit data"
- 70 UCS2 characters (2 bytes for each one) if <dc>="16-bit uncompressed UCS2 data"

Concatenated SMS (where supported) - "8-bit reference number" type

- 153 characters if <dc> = "GSM 7 bit default alphabet data"
- 134 octets if <dc> = "8-bit data"
- 67 UCS2 characters (2 bytes for each one) if <dc>="16-bit uncompressed UCS2 data"

Concatenated SMS (where supported) - "16-bit reference number" type

- The limits are the same as the "8-bit reference number" type, but are decreased by one unit

A concatenated SMS can have as many as 255 parts.

For a complete overview of SMS, see the 3GPP TS 23.040 [\[8\]](#).

10.2 Select message service +CSMS

+CSMS						
Modules	LEON-G SARA-G					
	LISA-U SARA-U					
Attributes	Syntax	PIN required	Settings saved	Can be aborted	Response time	Error reference
	full	Yes	No	No	-	+CMS Error

10.2.1 Description

Selects message service <service>. It returns the types of messages supported by the MT.

10.2.2 Syntax

Type	Syntax	Response	Example
Set	AT+CSMS=<service>	+CSMS: <mt>,<mo>,<bm> OK	AT+CSMS=1 +CSMS: 1,1,1 OK
Read	AT+CSMS?	+CSMS: <service>,<mt>,<mo>,<bm> OK	+CSMS: 0,1,1,1 OK
Test	AT+CSMS=?	+CSMS: (list of supported <service>s) OK	+CSMS: (0-1) OK

10.2.3 Defined values

Parameter	Type	Description
<service>	Number	<ul style="list-style-type: none"> 0: Refer to 3GPP TS 23.040 [8] and 3GPP TS 23.041 [9]; syntax of AT commands is compatible with 3GPP TS 27.005 [16] phase 2; phase 2+ features may be supported if no new command syntax is required 1: Refer to 3GPP TS 23.040 [8] and 3GPP TS 23.041 [9]; syntax of AT commands is compatible with 3GPP TS 27.005 [16] phase 2+
<mt>	Number	Mobile terminated messages <ul style="list-style-type: none"> 0: not supported 1: supported
<mo>	Number	Mobile originated messages <ul style="list-style-type: none"> 0: not supported 1: supported
<bm>	Number	Broadcast messages <ul style="list-style-type: none"> 0: not supported 1: supported

10.2.4 Notes

- Set <service> to 1 to acknowledge an incoming message (either SMS or Status Report) with +CNMA command.
- If <service> is changed from 1 to 0 and one or more parameters of the +CNMI command are in phase 2+, switch the +CNMI parameters to phase 2 specific values before entering phase 2.

10.3 Preferred message storage +CPMS

+CPMS						
Modules	LEON-G SARA-G LISA-U SARA-U					
Attributes	Syntax	PIN required	Settings saved	Can be aborted	Response time	Error reference
	partial	Yes	<i>NVM</i>	No	<i>Up to 3 min</i>	<i>+CMS Error</i>

10.3.1 Description

Selects memory storages <mem1>, <mem2> and <mem3>. If the chosen storage is supported by the MT but not suitable, the final result code +CMS ERROR: <err> should be returned.



See the test command for the supported memory types for each memory storage.

10.3.2 Syntax

Type	Syntax	Response	Example
Set	AT+CPMS=<mem1>[,<mem2> [,<mem3>]]	AT+CPMS: <used1>,<total1>,<used2>,<total2>,<used3>,<total3> OK	AT+CPMS="BM","SM","SM" +CPMS: 0,5,0,50,0,50 OK

Type	Syntax	Response	Example
Read	AT+CPMS?	+CPMS: <mem1>,<used1>,<total1>,<mem2>,<used2>,<total2>,<mem3>,<used3>,<total3> OK	+CPMS: "MT",4,350,"MT",4,350,"MT",4,350 OK
Test	AT+CPMS=?	+CPMS: (list of supported <mem1>s), (list of supported <mem2>s),(list of supported <mem3>s) OK	+CPMS: ("MT","ME","SM","BM","SR"),("MT","ME","SM"),("MT","ME","SM") OK

10.3.3 Defined values

Parameter	Type	Description
<mem1>	String	Memory used to read and delete messages. The supported values may vary. <ul style="list-style-type: none"> "ME" ME message storage "SM" (U)SIM message storage "MT" = "ME"+"SM", "ME" preferred (factory-programmed value) "BM" Broadcast Message storage "SR" Status Report storage
<mem2>	String	Memory used to write and send SMS. The supported values may vary. <ul style="list-style-type: none"> "ME" ME message storage "SM" (U)SIM message storage "MT" = "ME"+"SM", "ME" preferred (factory-programmed value)
<mem3>	String	Memory preferred to store the received SMS. The supported values may vary. <ul style="list-style-type: none"> "ME" ME message storage "SM" (U)SIM message storage "MT" = "ME"+"SM", "ME" preferred (factory-programmed value)
<used1>	Number	Number of used message locations in <mem1>
<total1>	Number	Total number of message locations in <mem1>
<used2>	Number	Number of used message locations in <mem2>
<total2>	Number	Total number of message locations in <mem2>
<used3>	Number	Number of used message locations in <mem3>
<total3>	Number	Total number of message locations in <mem3>

10.3.4 Notes

LEON-G

- <mem1> = "SR" (Status Report storage) is not supported.

SARA-G

- <mem1> = "SR" (Status Report storage) is not supported.

SARA-G300 / SARA-G310

- "ME" and "MT" message storages are not supported.
- The factory-programmed value is "SM", "SM" and "SM" .

10.4 Preferred message format +CMGF

+CMGF						
Modules	LEON-G SARA-G					
	LISA-U SARA-U					
Attributes	Syntax	PIN required	Settings saved	Can be aborted	Response time	Error reference
	full	Yes	<i>Profile</i>	No	-	<i>+CMS Error</i>

10.4.1 Description

Indicates to MT which input and output format of messages shall be used.

10.4.2 Syntax

Type	Syntax	Response	Example
Set	AT+CMGF=[<mode>]	OK	AT+CMGF=1 OK
Read	AT+CMGF?	+CMGF: <mode> OK	+CMGF: 1 OK
Test	AT+CMGF=?	+CMGF: (list of supported <mode>s) OK	+CMGF: (0-1) OK

10.4.3 Defined values

Parameter	Type	Description
<mode>	Number	Indicates the format of messages used with send, list, read and write commands and URCS resulting from receiving SMSes messages: <ul style="list-style-type: none"> • 0: PDU mode (default and factory-programmed value) • 1: text mode

10.5 Save settings +CSAS

+CSAS						
Modules	LEON-G SARA-G					
	LISA-U SARA-U					
Attributes	Syntax	PIN required	Settings saved	Can be aborted	Response time	Error reference
	full	No	<i>NVM</i>	No	-	<i>+CMS Error</i>

10.5.1 Description

Saves active message service settings from the current active memory (RAM) to non-volatile memory (NVM). The settings related to the +CSCA (the current SMSC address stored in RAM), +CSMP and +CSCB commands are stored in a specific SMS profile (only one profile is available).

10.5.2 Syntax

Type	Syntax	Response	Example
Set	AT+CSAS[=<profile>]	OK	AT+CSAS OK
Test	AT+CSAS=?	+CSAS: (list of supported <profile>s) OK	+CSAS: (0) OK

10.5.3 Defined values

Parameter	Type	Description
<profile>	Number	Specific SMS profile index where to store the active message settings. The factory-programmed value is 0.

10.6 Restore settings +CRES

+CRES						
Modules	LEON-G SARA-G					
	LISA-U SARA-U					
Attributes	Syntax	PIN required	Settings saved	Can be aborted	Response time	Error reference
	full	Yes	No	No	< 10 s	<i>+CMS Error</i>

10.6.1 Description

Restores message service settings from a non-volatile memory (NVM) to the current active memory (RAM). The settings related to the +CSCA (the SMSC address in the SIM card is also updated), +CSMP and +CSCB commands are read from a specific SMS profile (only one profile is available).

10.6.2 Syntax

Type	Syntax	Response	Example
Set	AT+CRES[=<profile>]	OK	AT+CRES=0 OK
Test	AT+CRES=?	+CRES: (list of supported <profile>s) OK	+CRES: (0) OK

10.6.3 Defined values

Parameter	Type	Description
<profile>	Number	Specific SMS profile index from where to read the message service settings

10.7 Show text mode parameters +CSDH

+CSDH						
Modules	LEON-G SARA-G					
	LISA-U SARA-U					
Attributes	Syntax	PIN required	Settings saved	Can be aborted	Response time	Error reference
	full	Yes	No	No	-	+CMS Error

10.7.1 Description

Controls whether detailed SMS header information is shown in text mode (+CMGF=1).

This affects the responses of the +CMGR ([Chapter 10.9](#)), +CMGL ([Chapter 10.11](#)), +CSMP ([Chapter 10.15](#)), +CSCA ([Chapter 10.17](#)) AT commands and the +CMT, +CMTI, +CDS, +CDSI, +CBM, +CBMI ([Chapter 10.8](#)) URCS.

10.7.2 Syntax

Type	Syntax	Response	Example
Set	AT+CSDH=[<show>]	OK	AT+CSDH=1 OK
Read	AT+CSDH?	+CSDH: <show> OK	+CSDH: 0 OK
Test	AT+CSDH=?	+CSDH: (list of supported <show>s) OK	+CSDH: (0-1) OK

10.7.3 Defined values

Parameter	Type	Description
<show>	Number	<ul style="list-style-type: none"> 0 (default value and factory-programmed setting): do not show detailed SMS header information 1: show detailed SMS header information

10.8 New message indication +CNMI

+CNMI						
Modules	LEON-G SARA-G					
	LISA-U SARA-U					
Attributes	Syntax	PIN required	Settings saved	Can be aborted	Response time	Error reference
	full	Yes	<i>Profile</i>	No	-	+CMS Error

10.8.1 Description

Selects the procedure to indicate the reception of a new SMS in case of DTR-signal ON. If MT is inactive (DTR-signal OFF), message reception should be done as specified in 3GPP TS 23.038 [7]. All SMS classes are supported accordingly.



 The SMSes of class 0 (normally displayed via MMI) are indicated on DTE via URC **+CMTI: "SM",0**, wherein 0 represents an SMS without SIM-storage ("SM" indicates only that no other specific setting is needed in order to read the SMS via AT+CMGR=0).

 The <tooa>, <fo>, <pid>, <dc>, <sca>, <tosca>, <length> parameters in the text mode +CMT URC are displayed only if +CSDH=1 is set.

10.8.2 Syntax

Type	Syntax	Response	Example
Set	AT+CNMI=[<mode>[,<mt>[,<bm>[,<ds>[,<bfr>]]]]]	OK	AT+CNMI=1,1 OK
Read	AT+CNMI=?	+CNMI: <mode>,<mt>,<bm>,<ds>,<bfr> OK	+CNMI: 0,0,0,0,0 OK
Test	AT+CNMI=?	+CNMI: (list of supported <mode>s),(list of supported <mt>s),(list of supported <bm>s),(list of supported <ds>s),(list of supported <bfr>s) OK	+CNMI: (0-2),(0-3),(0-3),(0-2),(0-1) OK
URC		+CMTI: <mem>,<index>	
URC		(PDU mode) +CMT: ,<length><CR><LF><pdu> (text mode) +CMT: <oa>,[<alpha>],<scts>[,<tooa>,<fo>,<pid>,<dc>,<sca>,<tosca>,<length>]<CR><LF><data>	
URC		+CBMI: <mem>,<index>	
URC		(PDU mode) +CBM: <length><CR><LF><pdu> (text mode) +CBM: <sn>,<mid>,<dc>,<page>,<pages><CR><LF> <data>	
URC		(PDU mode) +CDS: <length><CR><LF><pdu> (text mode) +CDS: <fo>,<mr>,[<ra>],[<tora>],<scts>,<dt>,<st>	
URC		+CDSI: <mem>,<index>	

10.8.3 Defined values

Parameter	Type	Description
<mode>	Number	Controls the processing of URCs specified within this command: <ul style="list-style-type: none"> 0 (default value): buffer URCs in the MT; if the MT buffer is full, the oldest indication may be discarded and replaced with the new received indications (ring buffer) 1 (factory-programmed setting): discard indication and reject new received message URCs when MT-DTE link is reserved; otherwise forward them directly to the DTE 2: buffer URCs in the MT when the serial link is busy (e.g. data-transfer); otherwise forward them directly to the DTE
<mt>	Number	Specifies the rules for managing the received SMS according the message's DCS (Data Coding Scheme): <ul style="list-style-type: none"> 0 (default value and factory-programmed setting): No SMS-DELIVER indications are routed to the TE 1: if SMS-DELIVER is stored in MT, indication of the memory location is routed to the DTE using the +CMTI URC

Parameter	Type	Description
		<ul style="list-style-type: none"> 2: SMS-DELIVER (except class 2 SMS) are routed directly to the DTE (but not saved in the module file system or SIM memory) using the +CMT URC. If MT has its own display device then class 0 SMS and SMS in the message waiting indication group (discard message) may be copied to both MT display and to DTE. In this case MT shall send the acknowledgement to the network. Class 2 SMSs and messages in the message waiting indication group (storage message) result in indication as defined in <mt>=1 3: Class 3 SMS-DELIVERs are routed directly to DTE using URCs defined in <mt>=2. Messages of other data coding schemes result in indication as defined in <mt>=1 <p> When <mt> is not set to 0 the arrival of an SMS is notified by switching the ring line from OFF to ON for 1 s.</p>
<bm>	Number	Specifies the rules for managing the received Cell Broadcast messages: <ul style="list-style-type: none"> 0 (default value and factory-programmed setting): No CBM indications to the DTE 1 if CBM is stored in RAM/NVM by MT, an indication of the used memory location is routed to DTE using the +CBMI URC 2: new CBMs are routed directly to the DTE using the +CBM URC 3: Class 3 CBMs are routed directly to DTE using URCs defined in <bm>=2. If CBM storage is supported, messages of other classes result in indication as defined in <bm>=1
<ds>	Number	Specifies the rules for managing the Status Report messages: <ul style="list-style-type: none"> 0 (default value and factory-programmed setting): No SMS-STATUS-REPORTs are routed to the DTE 1: SMS-STATUS-REPORTs are routed to the DTE using the +CDS URC 2: if SMS-STATUS-REPORT is stored into MT, indication of the memory location is routed to the DTE using the +CDSI URC
<bfr>	Number	Controls the buffering of URCs: <ul style="list-style-type: none"> 0 (default value and factory-programmed setting): MT buffer of URCs defined within this command is flushed to the DTE when <mode> 1...3 is entered (OK response shall be given before flushing the codes). 1: MT buffer of URCs defined within this command is cleared when <mode> 1...3 is entered
<mem>	String	Same as defined in Chapter 10.3.3
<index>	Number	Storage position
<length>	Number	Two meanings: <ul style="list-style-type: none"> in text mode: number of characters in PDU mode: PDU's length in octets without the Service Center's address. In example: 039121430100038166F6000004E374F80D: this is a PDU with Service Center's number +1234, that generates the address 03912143 (4 octets). Thus in this case <length>=13.
<pdu>	String	Protocol data unit: each 8-bit octet is presented as two IRA character long hexadecimal numbers, e.g. octet with integer value 42 is presented to TE as two characters 2A (IRA 50 and 65)
<oa>	String	Originator address
<scts>	String	Service center time stamp in time-string format, refer to <dt>
<data>	String	In the case of SMS: 3GPP TS 23.040 [8] TP-User-Data in text mode responses; format: <ul style="list-style-type: none"> if <dc> indicates that 3GPP TS 23.038 [7] GSM 7 bit default alphabet is used and <fo> indicates that 3GPP TS 23.040 [8] TP-User-Data-Header-Indication is not set: <ul style="list-style-type: none"> if TE character set other than "HEX" (refer command Select TE Character Set +CSCS in 3GPP TS 27.007 [2]): ME/TA converts GSM alphabet into current TE character set according to rules of Annex A if TE character set is "HEX": ME/TA converts each 7-bit character of GSM 7 bit default alphabet into two IRA character long hexadecimal number (e.g. character TODO: what character should go here? (GSM 7 bit default alphabet 23) is presented as 17 (IRA 49 and 55)) if <dc> indicates that 8-bit or UCS2 data coding scheme is used, or <fo> indicates that 3GPP TS 23.040 [8] TP-User-Data-Header-Indication is set: ME/TA converts each 8-bit octet into two IRA character long hexadecimal number (e.g. octet with integer value 42 is presented to TE as two characters 2A (IRA 50 and 65)) In the case of CBS: 3GPP TS 23.041 [9] CBM Content of Message in text mode responses; format: <ul style="list-style-type: none"> if <dc> indicates that 3GPP TS 23.038 [7] GSM 7 bit default alphabet is used: <ul style="list-style-type: none"> if TE character set other than "HEX" (refer command +CSCS in 3GPP TS 27.007 [2]): ME/TA converts GSM alphabet into current TE character set according to rules of Annex A

Parameter	Type	Description
		<ul style="list-style-type: none"> o if TE character set is "HEX": ME/TA converts each 7-bit character of the GSM 7 bit default alphabet into two IRA character long hexadecimal number • if <dc> indicates that 8-bit or UCS2 data coding scheme is used: ME/TA converts each 8-bit octet into two IRA character long hexadecimal number
<sn>	Number	CBM serial number
<mid>	Number	CBM message identifier
<dc>	Number	Data Coding Scheme
<page>	Number	CBM Page Parameter bits 4-7 in integer format as described in 3GPP TS 23.041 [9]
<pages>	Number	CBM Page Parameter bits 0-3 in integer format as described in 3GPP TS 23.041 [9]
<fo>	Number	First octet of the SMS TPDU (see 3GPP TS 23.040 [8])
<mr>	Number	Message reference
<ra>	String	Recipient address field
<tora>	Number	Type of address of <ra> - octet
<dt>	String	Discharge time in format "yy/MM/dd,hh:mm:ss+zz"; the time zone is expressed in steps of 15 minutes. The range goes from -48 to +56
<st>	Number	Status of a SMS STATUS-REPORT

10.8.4 Notes

- The incoming SMS URC indications will be displayed only on the AT interface where the last +CNMI was set. As a general rule, the +CNMI command should be issued by the DTE:
 - o After start-up
 - o After using the Z and &F command (which reset the CNMI configuration)
 - o Whenever the incoming SMS URCs indications are requested on a different AT interface

10.9 Read message +CMGR

+CMGR						
Modules	LEON-G SARA-G LISA-U SARA-U					
Attributes	Syntax	PIN required	Settings saved	Can be aborted	Response time	Error reference
	full	Yes	No	No	Up to 3 min (<1 s for prompt ">" when present)	+CMS Error

10.9.1 Description

Returns the message with location value <index> from message storage <mem1> to the DTE.



The parameters <tooa>,<fo>,<pid>,<dc>,<sca>,<tosca>,<length>,<cdata> shall be displayed only if +CSDH=1 is set.



The syntax AT+CMGR=0 allows to display an SMS class 0 if it is signalized to MT, because no MMI is available in the MT (see also the note from command +CNMI).



If the <index> value is out of range (it depends on AT+CPMS command setting) or it refers to an empty position, then the error "+CMS ERROR: invalid memory index" is returned.

10.9.2 Syntax

Type	Syntax	Response	Example
Set	Text mode (+CMGF=1): AT+CMGR=<index>	(SMS-DELIVER) +CMGR: <stat>,<oa>,[<alpha>],<scts>[,<tooa>,<fo>,<pid>,<dc>,<sca>,<tosca>,<length>] <data> OK (SMS-SUBMIT)	AT+CMGR=303 +CMGR: "REC READ", "+393488535999",,"07/04/05,18:02:28+08",145,4,0,0,"+393492000466",145,93 You have a missed called. Free information provided by your operator. OK



Type	Syntax	Response	Example
		+CMGR: <stat>,<da>,[<alpha>][<toda>,<fo>,<pid>,<dcs>,[<vp>],<sca>,<tosca>,<length>] <data> OK (SMS-STATUS-report) +CMGR: <stat>,<fo>,<mr>,[<ra>],[<tora>]<scts><dt>,<st> OK (SMS-COMMAND) +CMGR: <stat>,<fo>,<ct>[,<pid>,[<mn>],[<da>],[<toda>],<length>] [<cdata>]] OK (CBM storage) +CMGR: <stat>,<sn>,<mid>,<dcs>,<page>,<pages> <data> OK	
	PDU mode (+CMGF=0): AT+CMGR=<index>	+CMGR: <stat>,[<alpha>],<length> <pdu> OK	AT+CMGR=1 +CMGR: 1,,40 0791934329002000040 C91932309826614000080 70328045218018D4F29CFE0 6B5CBF379F87C4EBF41E4340 82E7FDDBC3 OK
Test	AT+CMGR=?	OK	

10.9.3 Defined values

Parameter	Type	Description
<index>	Number	Storage position
<stat>	Number	<ul style="list-style-type: none"> 0: in PDU mode or "REC UNREAD" in text mode: received unread SMS 1: in PDU mode or "REC READ" in text mode: received read SMS 2: in PDU mode or "STO UNSENT" in text mode: stored unsent SMS 3: in PDU mode or "STO SENT" in text mode: stored sent SMS 4: in PDU mode or "ALL" in text mode: all SMS messages
<oa>	String	Originator address
<alpha>	String	Alphanumeric representation of <da> or <a> corresponding to the entry found in the phonebook 3GPP TS 24.008 [12]. The parameter is not managed.
<scts>	String	Service center time stamp in time-string format, refer to <dt>
<tooa>	Number	Type of address of <oa> - octet
<fo>	Number	First octet of the SMS TPDU (see 3GPP TS 23.040 [8])
<pid>	Number	TP-Protocol-Identifier (default 0); refer to 3GPP TS 23.040 [8]
<dcs>	Number	Data Coding Scheme
<sca>	String	Service center address field
<tosca>	Number	Type of address of <sca> - octet in Number format (for more details refer to 3GPP TS 24.008 [12]); default 145 when string includes '+', otherwise default 129
<length>	Number	Two meanings: <ul style="list-style-type: none"> in text mode: number of characters in PDU mode: PDU's length in octets without the Service Center's address. In example:03912143 0100038166F600004E374F80D : this is a PDU with Service Center's number +1234, that generates the address 03912143 (4 octets). Thus in this case <length> = 13.

Parameter	Type	Description										
<data>	String	<p>In the case of SMS: 3GPP TS 23.040 [8] TP-User-Data in text mode responses; format:</p> <ul style="list-style-type: none"> if <dc> indicates that 3GPP TS 23.038 [7] GSM 7 bit default alphabet is used and <fo> indicates that 3GPP TS 23.040 [8] TP-User-Data-Header-Indication is not set: <ul style="list-style-type: none"> if TE character set other than "HEX" (refer command Select TE Character Set +CSCS in 3GPP TS 27.007 [2]); ME/TA converts GSM alphabet into current TE character set according to rules of Annex A if TE character set is "HEX": ME/TA converts each 7-bit character of GSM 7 bit default alphabet into two IRA character long hexadecimal number (e.g. character TODO: what character should go here? (GSM 7 bit default alphabet 23) is presented as 17 (IRA 49 and 55)) if <dc> indicates that 8-bit or UCS2 data coding scheme is used, or <fo> indicates that 3GPP TS 23.040 [8] TP-User-Data-Header-Indication is set: ME/TA converts each 8-bit octet into two IRA character long hexadecimal number (e.g. octet with integer value 42 is presented to TE as two characters 2A (IRA 50 and 65)) <p>In the case of CBS: 3GPP TS 23.041 [9] CBM Content of Message in text mode responses; format:</p> <ul style="list-style-type: none"> if <dc> indicates that 3GPP TS 23.038 [7] GSM 7 bit default alphabet is used: <ul style="list-style-type: none"> if TE character set other than "HEX" (refer command +CSCS in 3GPP TS 27.007 [2]); ME/TA converts GSM alphabet into current TE character set according to rules of Annex A if TE character set is "HEX": ME/TA converts each 7-bit character of the GSM 7 bit default alphabet into two IRA character long hexadecimal number if <dc> indicates that 8-bit or UCS2 data coding scheme is used: ME/TA converts each 8-bit octet into two IRA character long hexadecimal number 										
<da>	String	Destination address										
<todo>	Number	Type of address of <da> - octet										
<vp>	Number	<p>Format depending of the <fo> setting:</p> <ul style="list-style-type: none"> Relative format: validity period starting from when the SMS is received by the SMSC, in range 0-255 (default value 167); for more details refer to 3GPP TS 23.040 [8] <table border="1"> <thead> <tr> <th><vp></th> <th>Validity period value</th> </tr> </thead> <tbody> <tr> <td>0 to 143</td> <td>(TP-VP + 1) x 5 minutes (i.e. 5 minutes intervals up to 12 hours)</td> </tr> <tr> <td>144 to 167</td> <td>12 hours + ((TP-VP -143) x 30 minutes)</td> </tr> <tr> <td>168 to 196</td> <td>(TP-VP - 166) x 1 day</td> </tr> <tr> <td>197 to 255</td> <td>(TP-VP - 192) x 1 week</td> </tr> </tbody> </table> <ul style="list-style-type: none"> Absolute format: absolute time of the validity period termination in string format ("yy/MM/dd, hh:mm:ss+zz") (refer to 3GPP TS 23.040 [8]); the time zone is expressed in steps of 15 minutes. The range goes from -48 to +56 	<vp>	Validity period value	0 to 143	(TP-VP + 1) x 5 minutes (i.e. 5 minutes intervals up to 12 hours)	144 to 167	12 hours + ((TP-VP -143) x 30 minutes)	168 to 196	(TP-VP - 166) x 1 day	197 to 255	(TP-VP - 192) x 1 week
<vp>	Validity period value											
0 to 143	(TP-VP + 1) x 5 minutes (i.e. 5 minutes intervals up to 12 hours)											
144 to 167	12 hours + ((TP-VP -143) x 30 minutes)											
168 to 196	(TP-VP - 166) x 1 day											
197 to 255	(TP-VP - 192) x 1 week											
<mr>	Number	Message reference										
<ra>	String	Recipient address field										
<tora>	Number	Type of address of <ra> - octet										
<dt>	String	Discharge time in format "yy/MM/dd, hh:mm:ss+zz"; the time zone is expressed in steps of 15 minutes. The range goes from -48 to +56										
<st>	Number	Status of an SMS STATUS-REPORT										
<ct>	Number	TP-Command-Type (default 0)										
<mn>	Number	Refer to 3GPP TS 23.040 [8] TP-Message-Number in integer format										
<cdata>	String	TP-Command-Data in text mode responses										
<sn>	Number	CBM serial number										
<mid>	Number	CBM message identifier										
<page>	Number	3GPP TS 23.041 [9] CBM Page Parameter bits 4-7 in integer format										
<pages>	Number	3GPP TS 23.041 [9] CBM Page Parameter bits 0-3 in integer format										
<pdu>	String	Protocol data unit: each 8-bit octet is presented as two IRA character long hexadecimal numbers, e.g. octet with integer value 42 is presented to TE as two characters 2A (IRA 50 and 65)										

10.10 New message acknowledgement to MT+CNMA

+CNMA						
Modules	LEON-G SARA-G LISA-U SARA-U					
Attributes	Syntax	PIN required	Settings saved	Can be aborted	Response time	Error reference
	full	Yes	No	No	<150 s	+CMS Error

10.10.1 Description

Confirms the reception of a new message (SMS-DELIVER or SMS-STATUS-REPORT) which is routed directly to the TE (see the +CNMI command). This acknowledgement command shall be used when +CSMS parameter <service> equals 1. The MT shall not send another +CMT or +CDS (see the +CNMI command) unsolicited result codes to the TE before the previous one is acknowledged. If the MT does not get acknowledgement within required time (network timeout), the MT should respond as specified in 3GPP TS 24.011 [13] to the network. The MT shall automatically disable routing to the TE by setting both <mt> and <ds> values of +CNMI to zero. If the command is executed, but no acknowledgement is expected, or some other MT related error occurs, the final result code +CMS ERROR: <err> is returned.

In PDU mode, it is possible to send either positive (RP-ACK) or negative (RP-ERROR) acknowledgement to the network. The <n> parameter defines which one will be sent. Optionally (when <length> is greater than zero) an acknowledgement TPDU (SMS-DELIVER-REPORT for RP-ACK or RP-ERROR) may be sent to the network. The entering of PDU is done similarly as specified in +CMGS command, except that the format of <ackpdu> is used instead of <pdu> (i.e. SMSC address field is not present). The PDU shall not be bounded by double quotes.

10.10.2 Syntax

Type	Syntax	Response	Example
Set	Text mode (+CMGF=1):	OK	AT+CNMA
	AT+CNMA	OK	OK
	PDU mode (+CMGF=0):	OK	AT+CNMA=1,6
	AT+CNMA[=<n>[,<length> [PDU is given<Ctrl-Z>/<ESC>]]]	OK	>40FF000001D4 <Ctrl-Z> OK
Test	AT+CNMA=?	Text mode (+CMGF=1):	OK
		OK	
		PDU mode (+CMGF=0):	+CNMA: (0-2)
		+CNMA: (list of supported <n>s)	OK
		OK	

10.10.3 Defined values

Parameter	Type	Description
<n>	Number	<ul style="list-style-type: none"> 0: the command operates similarly as defined for the text mode 1: sends RP-ACK (or buffered result code received correctly) 2: sends RP-ERROR (if PDU is not given, ME/TA shall send SMS-DELIVER-REPORT with 3GPP TS 23.040 [8] TP-FCS value set to 'FF' (unspecified error cause))
<length>	Number	PDU's length in octets without the Service Center's address



10.11 List message +CMGL

+CMGL						
Modules	LEON-G SARA-G LISA-U SARA-U					
Attributes	Syntax	PIN required	Settings saved	Can be aborted	Response time	Error reference
	full	Yes	No	No	Up to 3 min (<1 s for prompt ">" when present)	+CMS Error

10.11.1 Description

Returns SMS messages with status value <stat> from message storage <mem1> to the DTE. Some are displayed only when setting +CSDH=1 (see +CSDH, [Chapter 10.7](#)). If status of the received message is "received unread", status in the storage changes to "received read".

10.11.2 Syntax

Type	Syntax	Response	Example
Set	Text mode (+CMGF=1): AT+CMGL[=<stat>]	Command successful and SMS-DELIVERs: +CMGL: <index>,<stat>,<oa>,<[alpha]>,<[scts]>,<[tooa]>,<length> <data> [+CMGL: <index>,<stat>,<oa>,<[alpha]>,<[scts]>,<[tooa]>,<length>]<data>[...]]	AT+CMGL +CMGL: 303,"REC READ","+393401234999",,"08/08/06,10:01:38+08" You have a missed called. Free information provided by your operator. OK
		Command successful and SMS-SUBMITs: +CMGL: <index>,<stat>,<da>,<[alpha]>,<[toda]>,<length> <data> [+CMGL: <index>,<stat>,<da>,<[alpha]>,<[toda]>,<length>]<data>[...]]	OK
		Command successful and SMS-STATUS-REPORTs: +CMGL: <index>,<stat>,<fo>,<mr>,<[ra]>,<[tora]>,<scts>,<dt>,<st> [+CMGL: <index>,<stat>,<fo>,<mr>,<[ra]>,<[tora]>,<scts>,<dt>,<st> [...]]	OK
		Command successful and SMS-COMMANDs: +CMGL: <index>,<stat>,<fo>,<ct> [+CMGL: <index>,<stat>,<fo>,<ct>[...]]	OK
		Command successful and CBM storage: +CMGL: <index>,<stat>,<sn>,<mid>,<page>,<pages><data> [+CMGL: <index>,<stat>,<sn>,<mid>,<page>,<pages>,<data>[...]]	OK
	PDU mode (+CMGF=0): AT+CMGL[=<stat>]	Command successful: +CMGL: <index>,<stat>,<[alpha]>,<length>,<pdu>	

Type	Syntax	Response	Example
		[+CMGL: <index>,<stat>,<alpha>], <length><pdu> [...]]	
Test	AT+CMGL=?	+CMGL: (list of supported <stat>s) OK	+CMGL: ("RECUNREAD","REC READ", "STO UNSENT","STO SENT","ALL") OK

10.11.3 Defined values

Parameter	Type	Description
<stat>	Number or String	Number type in PDU mode (default value: 4), or string type in text mode (default value: "ALL"); indicates the status of message in memory <ul style="list-style-type: none"> • 0: in PDU mode or "REC UNREAD" in text mode: received unread SMS messages • 1: in PDU mode or "REC READ" in text mode: received read SMS messages • 2: in PDU mode or "STO UNSENT" in text mode: stored unsent SMS messages • 3: in PDU mode or "STO SENT" in text mode: stored sent SMS messages • 4: in PDU mode or "ALL" in text mode: all SMS messages
<index>	Number	Storage position
<oa>	String	Originator address
<alpha>	String	Alphanumeric representation of <da> or <a> corresponding to the entry found in the phonebook 3GPP TS 24.008 [12]. The parameter is not managed.
<scts>	String	Service center time stamp in time-string format; refer to <dt>
<tooa>	Number	Type of address of <oa> - octet
<length>	Number	Two meanings: <ul style="list-style-type: none"> • in text mode: number of characters • in PDU mode: PDU's length in octets without the Service Center's address. In example: 03912143 0100038166F6000004E374F80D : this is a PDU with Service Center's number +1234, that generates the address 03912143 (4 octets). Thus in this case <length> = 13.
<data>	String	This is the TP-User-Data in text mode; the decoding depends on the DCS (Data Coding Scheme) and the FO (First Octet) of the SMS header 3GPP TS 23.040 [8]; format: <ul style="list-style-type: none"> • if DCS indicates that 3GPP TS 23.038 [7] GSM 7 bit default alphabet is used and FO indicates that 3GPP TS 23.040 [8] TP-User-Data-Header-Indication is not set: <ul style="list-style-type: none"> o if TE character set other than "HEX" (refer command Select TE Character Set +CSCS in 3GPP TS 27.007 [2]): ME/TA converts GSM alphabet into current TE character set according to rules of Annex A o if TE character set is "HEX": ME/TA converts each 7-bit character of GSM 7 bit default alphabet into two IRA character long hexadecimal number (e.g. character TODO: what character should go here? (GSM 7 bit default alphabet 23) is presented as 17 (IRA 49 and 55)) • if DCS indicates that 8-bit or UCS2 data coding scheme is used, or FO indicates that 3GPP TS 23.040 [8] TP-User-Data-Header-Indication is set: ME/TA converts each 8-bit octet into two IRA character long hexadecimal number (e.g. octet with integer value 42 is presented to TE as two characters 2A (IRA 50 and 65)) In the case of CBS: 3GPP TS 23.041 [9] CBM Content of Message in text mode responses; format: <ul style="list-style-type: none"> • if DCS indicates that 3GPP TS 23.038 [7] GSM 7 bit default alphabet is used: <ul style="list-style-type: none"> o if TE character set other than "HEX" (refer command +CSCS in 3GPP TS 27.007 [2]): ME/TA converts GSM alphabet into current TE character set according to rules of Annex A o if TE character set is "HEX": ME/TA converts each 7-bit character of the GSM 7 bit default alphabet into two IRA character long hexadecimal number if DCS indicates that 8-bit or UCS2 data coding scheme is used: ME/TA converts each 8-bit octet into two IRA character long hexadecimal number
<da>	String	Destination address
<toda>	Number	Type of address of <da> - octet
<fo>	Number	First octet of the SMS TPDU (see 3GPP TS 23.040 [8])
<mr>	Number	Message reference
<ra>	String	Recipient address field
<tora>	Number	Type of address of <ra> - octet
<dt>	String	Discharge time in format "yy/MM/dd,hh:mm:ss+zz"; the time zone is expressed in steps of 15 minutes. The range goes from -48 to +56

Parameter	Type	Description
<st>	Number	Status of an SMS STATUS-REPORT
<ct>	Number	TP-Command-Type (default 0)
<sn>	Number	CBM serial number
<mid>	Number	CBM message identifier
<page>	Number	3GPP TS 23.041 [9] CBM Page Parameter bits 4-7 in integer format
<pages>	Number	3GPP TS 23.041 [9] CBM Page Parameter bits 0-3 in integer format
<pdu>	String	Protocol data unit: each 8-bit octet is presented as two IRA character long hexadecimal numbers, e.g. octet with integer value 42 is presented to TE as two characters 2A (IRA 50 and 65)
<dcs>	Number	Data Coding Scheme

10.12 Send message +CMGS

+CMGS						
Modules	LEON-G SARA-G					
	LISA-U SARA-U					
Attributes	Syntax	PIN required	Settings saved	Can be aborted	Response time	Error reference
	full	Yes	No	No	Up to 3 min (<1 s for prompt ">" when present)	+CMS Error

10.12.1 Description

Sends a message from a DTE to the network (SMS-SUBMIT). The message reference value <mr> is returned to the DTE for a successful message delivery. <Ctrl-Z> indicates that the SMS shall be sent, while <ESC> indicates aborting of the edited SMS.



The entered text/PDU is preceded by a ">" (Greater-Than sign) character, and this indicates that the interface is in "text/PDU enter" mode. The DCD signal shall be in ON state while the text/PDU is entered.

10.12.2 Syntax

Type	Syntax	Response	Example
Set	Text mode (+CMGF=1):	+CMGS: <mr>	AT+CMGS="0171112233"<CR>
	AT+CMGS=<da>[,< toda>]-<CR>	OK	> This is the text<Ctrl-Z>
	text is entered<Ctrl-Z/ESC>		+CMGS:2 OK
PDU mode (+CMGF=0):		+CMGS: <mr>	AT+CMGS=13<CR>
	AT+CMGS=<length><CR>	OK	> 039121430100038166F6000004E374F80D<Ctrl-Z>
	PDU is given<Ctrl-Z/ESC>		+CMGS:2 OK
Test	AT+CMGS=?	OK	

10.12.3 Defined values

Parameter	Type	Description
<da>	String	Destination address
<toda>	Number	Type of address of <da> - octet
<text>	String	SMS String
<mr>	Number	Message reference
<length>	Number	Two meanings: <ul style="list-style-type: none"> in text mode: number of characters in PDU mode: PDU's length in octets without the Service Center's address. In example: 03912143 0100038166F6000004E374F80D is a PDU with Service Center's number +1234, that generates the address 03912143 (4 octets). Thus in this case <length>=13.

Parameter	Type	Description
<PDU>	String	Protocol Data Unit: each 8-bit octet of the PDU must be written as two IRA character long hexadecimal numbers, e.g. octet with integer value 42 must be written as two characters 2A (IRA 50 and 65)

10.13 Write message to memory +CMGW

+CMGW						
Modules	LEON-G SARA-G					
	LISA-U SARA-U					
Attributes	Syntax	PIN required	Settings saved	Can be aborted	Response time	Error reference
	full	Yes	No	No	<10 s	+CMS Error

10.13.1 Description

Stores a message (SMS-DELIVER or SMS-SUBMIT) to memory storage <mem2> and returns the memory location <index> of the stored message. <Ctrl-Z> indicates that the SMS shall be stored, while <ESC> indicates aborting of the edited SMS.

 The entered text/PDU is preceded by a ">" (Greater-Than sign) character, and this indicates that the interface is in "text/PDU enter" mode. The DCD signal shall be in ON state while the text/PDU is entered.

10.13.2 Syntax

Type	Syntax	Response	Example
Set	Text mode (+CMGF=1): AT+CMGW[=<oa/da>[,<tooa/toda>[,<stat>]]]<CR> text is entered<Ctrl-Z/ESC>	+CMGW: <index> OK	AT+CMGW="091137880"<CR> > This is the text<Ctrl-Z> +CMGW:303 OK
	PDU mode (+CMGF=0): AT+CMGW=<length>[,<stat>]<CR> PDU is given<Ctrl-Z/ESC>	+CMGW: <index> OK	AT+CMGW=13<CR> > 039121430100038166F600000 4E374F80D<Ctrl-Z> +CMGW:303 OK
Test	AT+CMGW=?	OK	

10.13.3 Defined values

Parameter	Type	Description
<da>	String	3GPP TS 23.040 [3] TP-Destination-Address Address-Value field in string format; BCD numbers (or GSM 7 bit default alphabet characters) are converted to characters of the currently selected TE character set (refer command +CSCS in 3GPP TS 27.007 [9]); type of address given by <toda>
<oa>	String	3GPP TS 23.040 [8] TP-Originating-Address Address-Value field in string format; BCD numbers (or GSM 7 bit default alphabet characters) are converted to characters of the currently selected TE character set (refer command +CSCS in 3GPP TS 27.007 [2]); type of address given by <tooa>
<tooa>	Number	3GPP TS 24.011 [13] TP-Originating-Address Type-of-Address octet in integer format (default value: refer to <toda>)
<toda>	Number	3GPP TS 24.011 [13] TP-Destination-Address Type-of-Address octet in integer format (when first character of <da> is + (IRA 43) default is 145, otherwise default is 129)
<stat>	Number or String	Number type in PDU mode (default value: 4), or string type in text mode (default value: "ALL"); indicates the status of message in memory <ul style="list-style-type: none"> • 0: in PDU mode or "REC UNREAD" in text mode: received unread SMS messages • 1: in PDU mode or "REC READ" in text mode: received read SMS messages • 2: in PDU mode or "STO UNSENT" in text mode: stored unsent SMS messages • 3: in PDU mode or "STO SENT" in text mode: stored sent SMS messages • 4: in PDU mode or "ALL" in text mode: all SMS messages
<text>	String	SMS String



Parameter	Type	Description
<index>	Number	Storage position
<length>	Number	Two meanings: <ul style="list-style-type: none"> in text mode: number of characters in PDU mode: PDU's length in octets without the Service Center's address. In example: 03912143 0100038166F6000004E374F80D is a PDU with Service Center's number +1234, that generates the address 03912143 (4 octets). Thus in this case <length>=13.
<PDU>	String	Protocol Data Unit: each 8-bit octet of the PDU must be written as two IRA character long hexadecimal numbers, e.g. octet with integer value 42 must be written as two characters 2A (IRA 50 and 65)

10.14 Send message from storage +CMSS

+CMSS						
Modules	LEON-G SARA-G					
	LISA-U SARA-U					
Attributes	Syntax	PIN required	Settings saved	Can be aborted	Response time	Error reference
	full	Yes	No	No	Up to 3 min (<1 s for prompt ">" when present)	+CMS Error

10.14.1 Description

Sends message with location value <index> from the preferred message storage <mem2> to the network (SMS-SUBMIT or SMS-COMMAND). If a new recipient address <da> is given for SMS-SUBMIT, it will be used instead of the one stored with the message. Reference value <mr> is returned to the DTE on successful message delivery.

10.14.2 Syntax

Type	Syntax	Response	Example
Set	Text mode (+CMGF=1):	+CMSS: <mr>	AT+CMSS=302
	AT+CMSS=<index>[,<da>[,< toda>]]	OK	+CMSS: 3 OK
	PDU mode (+CMGF=0):	+CMSS: <mr>	AT+CMSS=302
	AT+CMSS=<index>	OK	+CMSS: 4 OK
Test	AT+CMSS=?	OK	

10.14.3 Defined values

Parameter	Type	Description
<index>	Number	Storage position
<da>	String	Destination address
< toda>	Number	Type of address of <da> - octet
<mr>	Number	Message reference

10.15 Set text mode parameters +CSMP

+CSMP						
Modules	LEON-G SARA-G					
	LISA-U SARA-U					
Attributes	Syntax	PIN required	Settings saved	Can be aborted	Response time	Error reference
	full	Yes	No	No	< 10 s	+CMS Error

10.15.1 Description

Selects values for additional parameters needed when SMS is sent to the network or placed in a storage when text format message mode is selected. For more details refer to 3GPP TS 23.038 [7] and 3GPP TS 23.040 [8].

10.15.2 Syntax

Type	Syntax	Response	Example
Set	AT+CSMP=<fo>,<vp>[,<pid>[,<dcs>]]	OK	AT+CSMP=17,167,0,0 OK
Read	AT+CSMP?	+CSMP: <fo>,<vp>,<pid>,<dcs> OK	+CSMP: 17,167,0,0 OK
Test	AT+CSMP=?	OK	

10.15.3 Defined values

Parameter	Type	Description	
<fo>	Number	First octet of the SMS TPDU (see 3GPP TS 23.040 [8])	
<vp>	Number	Format depending on the values of the bit3/bit4 of the <fo> (SMS-SUBMIT case):	
	bit 3	bit 4	
	0	0	Format Validity period not present
	0	1	Validity period present, relative format
	1	0	Reserved
	1	1	Validity period present, absolute format
			<ul style="list-style-type: none"> Relative format: validity period, counted from when the SMS-SUBMIT is received by the SMSC, in range 0-255 (default value 167); for more details refer to 3GPP TS 23.040 [8]
	<vp>	Validity period value	
	0 to 143	(TP-VP + 1) x 5 minutes (i.e. 5 minutes intervals up to 12 hours)	
	144 to 167	12 hours + ((TP-VP - 143) x 30 minutes)	
	168 to 196	(TP-VP - 166) x 1 day	
	197 to 255	(TP-VP - 192) x 1 week	
		<ul style="list-style-type: none"> Absolute format: absolute time of the validity period termination in string format ("yy/MM/dd,hh:mm:ss+zz") (refer to 3GPP TS 23.040 [8]); the time zone is expressed in steps of 15 minutes. The range goes from -48 to +56 	
<pid>	Number	TP-Protocol-Identifier (default 0); refer to 3GPP TS 23.040 [8]	
<dcs>	Number	Data Coding Scheme. Default value is 0	

10.16 Delete message +CMGD

+CMGD						
Modules	LEON-G SARA-G					
	LISA-U SARA-U					
Attributes	Syntax	PIN required	Settings saved	Can be aborted	Response time	Error reference
	partial	Yes	No	No	<55 s	+CMS Error

10.16.1 Description

Deletes the message from the preferred message storage <mem1>, if <flag> = 0 or not present, in location <index>. Otherwise the messages are deleted following the rules specified by <flag>.



When deleting a message from an empty location, the module returns "OK".



If the <index> value is out of range (it depends on AT+CPMS command setting), then the error "+CMS ERROR: invalid memory index" is returned.

10.16.2 Syntax

Type	Syntax	Response	Example
Set	AT+CMGD=<index>[,<flag>]	OK	AT+CMGD=3

Type	Syntax	Response	Example
Test	AT+CMGD=?	+CMGD: (list of supported <index>s),(list of supported <flag>s) OK	OK +CMGD: (1-350),(0-4) OK

10.16.3 Defined values

Parameter	Type	Description
<index>	Number	Storage position
<flag>	Number	Deletion flag. If present, and different from 0, <index> is ignored: <ul style="list-style-type: none"> • 0 (default value): delete the message specified in <index> • 1: delete all the read messages from the preferred message storage, leaving unread messages and stored mobile originated messages (whether sent or not) untouched • 2: delete all the read messages from the preferred message storage and sent mobile originated messages, leaving unread messages and unsent mobile originated messages untouched • 3: delete all the read messages from the preferred message storage, sent and unsent mobile originated messages leaving unread messages untouched • 4: delete all the messages from the preferred message storage including unread messages

10.16.4 Notes

LEON-G / SARA-G

- The "BM" memory entries cannot be deleted.

10.17 Service center address +CSCA

+CSCA						
Modules	LEON-G SARA-G LISA-U SARA-U					
Attributes	Syntax	PIN required	Settings saved	Can be aborted	Response time	Error reference
	full	Yes	No	No	< 10 s	+CMS Error

10.17.1 Description

Updates the SMSC address, through which mobile originated SMSes are transmitted. In text mode the setting is used by send and write commands. In PDU mode the setting is used by the same commands, but only when the length of SMSC address coded into <pdu> parameter equals zero.



This command sets the service center value both in the RAM (this value is actually the SMSC address used) and in the SIM card. Through the read command the value of current service center stored in the RAM is displayed. At the power on, the MT reads the SMSC address in the SIM card and the same value is set in RAM.

10.17.2 Syntax

Type	Syntax	Response	Example
Set	AT+CSCA=<sca>[,<tosca>]	OK	AT+CSCA="0170111000",129 OK
Read	AT+CSCA?	+CSCA: <sca>,<tosca> OK	+CSCA: "",129 OK
Test	AT+CSCA=?	OK	

10.17.3 Defined values

Parameter	Type	Description
<sca>	String	Service center address

Parameter	Type	Description
<tosca>	String	Type of address of <sca> (for more details refer to 3GPP TS 24.008 [12]); default 145 when string includes '+', otherwise default 129

10.18 Select cell broadcast message types +CSCB

+CSCB						
Modules	LEON-G SARA-G LISA-U SARA-U					
Attributes	Syntax	PIN required	Settings saved	Can be aborted	Response time	Error reference
	full	Yes	No	No	< 10 s	+CMS Error

10.18.1 Description

This set command selects which types of CBM's are to be received by the MT.

10.18.2 Syntax

Type	Syntax	Response	Example
Set	AT+CSCB=[<mode>[,<mids>[,<dcss>]]]	OK	AT+CSCB=0,"1,5,10-11,40", "" OK
Read	AT+CSCB=?	+CSCB: <mode>,<mids>,<dcss> OK	+CSCB: 0,"", "" OK
Test	AT+CSCB=?	+CSCB: (list of supported <mode>s) OK	+CSCB: (0-1) OK

10.18.3 Defined values

Parameter	Type	Description
<mode>	Number	<ul style="list-style-type: none"> 0: message types specified in <mids> and <dcss> are accepted 1: message types specified in <mids> and <dcss> are not accepted
<mids>	String	Contains all possible combinations of CBM message identifiers (<mid>). Refer to 3GPP TS 23.041 [9], chapter 9.4. When RAT is UMTS up to 2048 message identifiers can be set; defining an exceeding combination will not cause an error response and exceeding values will be ignored.
<dcss>	String	Contains all possible combinations of CBM data coding schemes (<dcs>). Refer to 3GPP TS 23.038 [7], chapter 5

10.18.4 Notes

- If <mode>=0 and <mids> is an empty string, receiving of CB SMS is stopped.

LISA-U1

- When RAT is UMTS up to 1024 message identifiers can be set.

10.19 Read concatenated message +UCMGR







+UCMGR						
Modules	LEON-G SARA-G					
Attributes	Syntax	PIN required	Settings saved	Can be aborted	Response time	Error reference
	full	Yes	No	No	Up to 3 min (<1 s for prompt ">" when present)	+CMS Error

10.19.1 Description

Returns the message with location value <index> from message storage <mem1> to the DTE and shows additional information when the message is a segment of a concatenated one.

-  For SMS-DELIVER the parameters <toa>, <fo>, <pid>, <dcs>, <sca>, <tosca>, <length> shall be displayed only if +CSDH=1 is set.



-  For SMS-SUBMIT the parameters <todo>, <fo>, <pid>, <dcsc>, <vp>, <sca>, <tosca>, <length> shall be displayed only if +CSDH=1 is set.
-  For SMS-COMMAND <pid>, <mn>, <da>, <todo>, <length> <cdata> shall be displayed only if +CSDH=1 is set.
-  The syntax AT+UCMGR=0 allows to display an SMS class 0 if it is signalized to MT, because no MMI is available in the MT (see also the note from command +CNMI, [Chapter 10.8](#)).
-  If status of the received message is "received unread", status in the storage changes to "received read".
-  The command is supported only for text mode (+CMGF=1).
-  If the <index> value is out of range (it depends on the preferred message storage, +CPMS command, settings) or it refers to an empty position, then the error "+CMS ERROR: invalid memory index" is returned.

10.19.2 Syntax

Type	Syntax	Response	Example
Set	AT+UCMGR=<index>	(SMS-DELIVER) +UCMGR: <stat>,<oa>,[<alpha>], <scts>[,<tooa>, <fo>,<pid>,<dcsc>, <sca>,<tosca>,<length>][,<seq>,<max>, <iei>,<ref>] <data> OK (SMS-SUBMIT) +UCMGR: <stat>,<da>,[<alpha>] [<todo>,<fo>,<pid>,<dcsc>,[<vp>],<sca>, <tosca>,<length>][,<seq>,<max>,<iei>, <ref>] <data> OK (SMS-STATUS-report) +UCMGR:<stat>,<fo>,<mr>,[<ra>], [<tora>]<scts><dt>,<st> OK (SMS-COMMAND) +UCMGR: <stat>,<fo>,<ct>[,<pid>, [<mn>],[<da>],[<todo>],<length> [<cdata>]] OK (CBM storage) +UCMGR: <stat>,<sn>,<mid>,<dcsc>, <page>,<pages> <data> OK	AT+UCMGR=1 +UCMGR:"REC READ", "+393488535999" ,"07/04/05,18:0 2:28+08",145,4,0,0,"+393492000466", 145,153,1,2,0,127 u-blox reserves all rights to this document and the information contained herein. Reproduction, use or disclosure to third parties without express permis OK
Test	AT+UCMGR=?	OK	

10.19.3 Defined values

Parameter	Type	Description
<index>	Number	Storage position
<stat>	String	Indicates the status of message in memory:



Parameter	Type	Description
		<ul style="list-style-type: none"> "REC UNREAD": received unread SMS "REC READ": received read SMS "STO UNSENT": stored unsent SMS "STO SENT": stored sent SMS "ALL": all SMS messages
<oa>	String	Originator address
<alpha>	String	Alphanumeric representation of <da> or <oa> corresponding to the entry found in the phonebook 3GPP TS 24.008 [12]. The parameter is not managed.
<scts>	String	Service center time stamp in time-string format, refer to <dt>
<tooa>	Number	Type of address of <oa> - octet
<fo>	Number	First octet of the SMS TPDU (see 3GPP TS 23.040 [8])
<pid>	Number	TP-Protocol-Identifier (default 0); refer to 3GPP TS 23.040 [8]
<dcs>	Number	Data Coding Scheme
<sca>	String	Service center address field
<tosca>	Number	Type of address of <sca> - octet in Number format (for more details refer to 3GPP TS 24.008 [12]); default 145 when string includes '+', otherwise default 129
<length>	Number	Number of characters
<seq>	Number	Sequence number of the current short message (1-255)
<max>	Number	Maximum number of short messages in the concatenated short message (1-255)
<iei>	Number	Information Element Identifier, the possible values are the following: <ul style="list-style-type: none"> 0: Concatenated short messages, 8-bit reference number 8: Concatenated short messages, 16-bit reference number
<ref>	Number	Concatenated short message reference number: <ul style="list-style-type: none"> 0-255: Concatenated short messages, 8-bit reference number case 0-65535: Concatenated short messages, 16-bit reference number case
<data>	String	<p>In the case of SMS: 3GPP TS 23.040 [8] TP-User-Data in text mode responses; format:</p> <ul style="list-style-type: none"> if <dcs> indicates that 3GPP TS 23.038 [7] GSM 7 bit default alphabet is used and <fo> indicates that 3GPP TS 23.040 [8] TP-User-Data-Header-Indication is not set: <ul style="list-style-type: none"> if TE character set other than "HEX" (refer command Select TE Character Set +CSCS Chapter 4.10): ME/TA converts GSM alphabet into current TE character set according to rules of 3GPP TS 27.005 [16] Annex A if TE character set is "HEX": ME/TA converts each 7-bit character of GSM 7 bit default alphabet into two IRA character long hexadecimal number (e.g. character TODO: what character should go here? (GSM 7 bit default alphabet 23) is presented as 17 (IRA 49 and 55)) if <dcs> indicates that 8-bit or UCS2 data coding scheme is used, or <fo> indicates that 3GPP TS 23.040 [8] TP-User-Data-Header-Indication is set: ME/TA converts each 8-bit octet into two IRA character long hexadecimal number (e.g. octet with integer value 42 is presented to TE as two characters 2A (IRA 50 and 65)) <p>In the case of CBS: 3GPP TS 23.041 [9] CBM Content of Message in text mode responses; format:</p> <ul style="list-style-type: none"> if <dcs> indicates that 3GPP TS 23.038 [7] GSM 7 bit default alphabet is used: <ul style="list-style-type: none"> if TE character set other than "HEX" (refer command +CSCS chapter 26.15): ME/TA converts GSM alphabet into current TE character set according to rules of 3GPP TS 27.005 [16] Annex A if TE character set is "HEX": ME/TA converts each 7-bit character of the GSM 7 bit default alphabet into two IRA character long hexadecimal number if <dcs> indicates that 8-bit or UCS2 data coding scheme is used: ME/TA converts each 8-bit octet into two IRA character long hexadecimal number
<da>	String	Destination address
<today>	Number	Type of address of <da> - octet
<vp>	Number	<p>Format depending of the <fo> setting:</p> <ul style="list-style-type: none"> Relative format: validityperiod starting from when the SMS is received by the SMSC, in range 0-255 (default value 167); for more details refer to 3GPP TS 23.040 [8]
	<vp>	Validity period value
	0 to 143	(TP-VP + 1) x 5 minutes (i.e. 5 minutes intervals up to 12 hours)
	144 to 167	12 hours + ((TP-VP -143) x 30 minutes)





Parameter	Type	Description
		168 to 196 (TP-VP - 166) x 1 day
		197 to 255 (TP-VP - 192) x 1 week
		Absolute format: absolute time of the validity period termination in string format ("yy/MM/dd, hh:mm:ss+zz") (refer to 3GPP TS 23.040 [8]); the time zone is expressed in steps of 15 minutes. The range goes from -48 to +56
<mr>	Number	Message reference
<ra>	String	Recipient address field
<tora>	Number	Type of address of <ra> - octet
<scts>	String	Service center time stamp in time-string format, refer to <dt>
<dt>	String	Discharge time in format "yy/MM/dd, hh:mm:ss+zz"; the time zone is expressed in steps of 15 minutes. The range goes from -48 to +56
<st>	Number	Status of an SMS STATUS-REPORT
<ct>	Number	TP-Command-Type (default 0)
<mn>	Number	3GPP TS 23.040 [8] TP-Message-Number in integer format
<mid>	Number	CBM message identifier
<cdata>	String	TP-Command-Data in text mode responses
<sn>	Number	CBM serial number
<page>	Number	3GPP TS 23.041 [9] CBM Page Parameter bits 4-7 in integer format
<pages>	Number	3GPP TS 23.041 [9] CBM Page Parameter bits 0-3 in integer format

10.20 List concatenated message +UCMGL

+UCMGL						
Modules	LEON-G SARA-G					
Attributes	Syntax	PIN required	Settings saved	Can be aborted	Response time	Error reference
	full	Yes	No	No	Up to 3 min (<1 s for prompt ">" when present)	+CMS Error

10.20.1 Description

Returns SMS messages with status value <stat> from message storage <mem1> to the DTE and shows additional information when the message is a segment of a concatenated one.

-  For SMS-DELIVER the parameters <toa>, <length> shall be displayed only if +CSDH=1 is set.
-  For SMS-SUBMIT the parameters <toda>, <length> shall be displayed only if +CSDH=1 is set.
-  If status of the received message is "received unread", status in the storage changes to "received read".
-  The command is supported only for text mode (+CMGF=1).

10.20.2 Syntax

Type	Syntax	Response	Example
Set	AT+UCMGL[=<stat>]	SMS-DELIVERs: +UCMGL: <index>,<stat>,<oa>, [<alpha>],[<scts>],[<toa>,<length>][, <seq>,<max>,<iei>,<ref>] <data> [+UCMGL: <index>,<stat>,<oa>, [<alpha>],[<scts>],[<toa>,<length>][, <seq>,<max>,<iei>,<ref>]<data>[...]] OK	AT+UCMGL +UCMGL: 304,"REC READ","+39340 1234999",,"08/08/06,10:01:38+08", 145,152,1,2,8,32767 u-blox reserves all rights to this document and the information contained herein. Reproduction, use or disclosure to third parties without express permi +UCMGL: 305,"REC READ","+39340 1234999",,"08/08/06,10:01:40+08", 145,29,2,2,8,32767

Type	Syntax	Response	Example
			ssion is strictly prohibited. OK
		SMS-SUBMITs: +UCMGL: <index>,<stat>,<da>, [<alpha>],[<toa>,<length>][,<seq>, <max>,<iei>,<ref>] <data> [+UCMGL: <index>,<stat>,<da>, [<alpha>],[<toa>,<length>][,<seq>, <max>,<iei>,<ref>]<data>[...]] OK	
		SMS-STATUS-REPORTs: +UCMGL: <index>,<stat>,<fo>,<mr>, [<ra>],[<tora>],<scts>,<dt>,<st> [+UCMGL: <index>,<stat>,<fo>,<mr>, [<ra>],[<tora>],<scts>,<dt>,<st> [...]] OK	
		SMS-COMMANDs: +UCMGL: <index>,<stat>,<fo>,<ct> [+UCMGL: <index>,<stat>,<fo>,<ct>[...]] OK	
		CBM storage: +UCMGL: <index>,<stat>,<sn>,<mid>, <page>,<pages><data> [+UCMGL: <index>,<stat>,<sn>,<mid>, <page>,<pages>,<data>[...]] OK	
Test	AT+UCMGL=?	+UCMGL: (list of supported <stat>s) OK	+UCMGL: ("REC UNREAD","REC READ", "STO UNSENT","STO SENT","ALL ") OK

10.20.3 Defined values

Parameter	Type	Description
<stat>	String	Indicates the status of message in memory: <ul style="list-style-type: none"> "REC UNREAD": received unread SMS messages "REC READ": received read SMS messages "STO UNSENT": stored unsent SMS messages "STO SENT": stored sent SMS messages "ALL": all SMS messages (default value)
<index>	Number	Storage position
<oa>	String	Originator address
<alpha>	String	Alphanumeric representation of <da> or <oa> corresponding to the entry found in the phonebook 3GPP TS 24.008 [12]. The parameter is not managed.
<scts>	String	Service center time stamp in time-string format; refer to <dt>
<toa>	Number	Type of address of <oa> - octet
<length>	Number	Number of characters
<seq>	Number	Sequence number of the current short message (1-255)
<max>	Number	Maximum number of short messages in the concatenated short message (1-255)
<iei>	Number	Information Element Identifier, the possible values are the following: <ul style="list-style-type: none"> 0: Concatenated short messages, 8-bit reference number 8: Concatenated short messages, 16-bit reference number
<ref>	Number	Concatenated short message reference number:

Parameter	Type	Description
		<ul style="list-style-type: none"> 0-255: Concatenated short messages, 8-bit reference number case 0-65535: Concatenated short messages, 16-bit reference number case
<data>	String	<p>In the case of SMS: 3GPP TS 23.040 [8] TP-User-Data in text mode responses; format:</p> <ul style="list-style-type: none"> if <dc> indicates that 3GPP TS 23.038 [7] GSM 7 bit default alphabet is used and <fo> indicates that 3GPP TS 23.040 [8] TP-User-Data-Header-Indication is not set: <ul style="list-style-type: none"> if TE character set other than "HEX" (refer command Select TE Character Set +CSCS chapter 26.15): ME/TA converts GSM alphabet into current TE character set according to rules of 3GPP TS 27.005 Annex A [16] if TE character set is "HEX": ME/TA converts each 7-bit character of GSM 7 bit default alphabet into two IRA character long hexadecimal number (e.g. character TODO: what character should go here? (GSM 7 bit default alphabet 23) is presented as 17 (IRA 49 and 55)) if <dc> indicates that 8-bit or UCS2 data coding scheme is used, or <fo> indicates that 3GPP TS 23.040 [8] TP-User-Data-Header-Indication is set: ME/TA converts each 8-bit octet into two IRA character long hexadecimal number (e.g. octet with integer value 42 is presented to TE as two characters 2A (IRA 50 and 65)) <p>In the case of CBS: 3GPP TS 23.041 [9] CBM Content of Message in text mode responses; format:</p> <ul style="list-style-type: none"> if <dc> indicates that 3GPP TS 23.038 [7] GSM 7 bit default alphabet is used: <ul style="list-style-type: none"> if TE character set other than "HEX" (refer command +CSCS chapter 26.15): ME/TA converts GSM alphabet into current TE character set according to rules of 3GPP TS 27.005 [16] Annex A if TE character set is "HEX": ME/TA converts each 7-bit character of the GSM 7 bit default alphabet into two IRA character long hexadecimal number if <dc> indicates that 8-bit or UCS2 data coding scheme is used: ME/TA converts each 8-bit octet into two IRA character long hexadecimal number
<da>	String	Destination address
<tda>	Number	Type of address of <da> - octet
<fo>	Number	First octet of the SMS TPDU (see 3GPP TS 23.040 [8])
<mr>	Number	Message reference
<ra>	String	Recipient address field
<tora>	Number	Type of address of <ra> - octet
<dt>	String	Discharge time in format "yy/MM/dd,hh:mm:ss+zz"; the time zone is expressed in steps of 15 minutes. The range goes from -48 to +56
<st>	Number	Status of an SMS STATUS-REPORT
<ct>	Number	TP-Command-Type (default 0)
<sn>	Number	CBM serial number
<mid>	Number	CBM message identifier
<page>	Number	3GPP TS 23.041 [9] CBM Page Parameter bits 4-7 in integer format
<pages>	Number	3GPP TS 23.041 [9] CBM Page Parameter bits 0-3 in integer format
<dc>	Number	Data Coding Scheme

10.21 Send concatenated message +UCMGS

+UCMGS						
Modules	LEON-G SARA-G					
Attributes	Syntax	PIN required	Settings saved	Can be aborted	Response time	Error reference
	full	Yes	No	No	Up to 3 min (<1 s for prompt ">" when present)	+CMS Error

10.21.1 Description

Sends one segment of a concatenated message from a DTE to the network (SMS-SUBMIT). The message reference value <mr> is returned to the DTE for a successful message delivery. <Ctrl-Z> indicates that the SMS shall be sent, while <ESC> indicates aborting of the edited SMS.

 The command is supported only for text mode (+CMGF=1).



 The entered text is preceded by a ">" (Greater-Than sign) character, and this indicates that the interface is in "text enter" mode. The DCD signal shall be in ON state while the text is entered.

10.21.2 Syntax

Type	Syntax	Response	Example
Set	AT+UCMGS=<da>,<[< toda>],<seq>,<max>,<iei>,<ref><CR> text is entered<Ctrl-Z/ESC>	+UCMGS: <mr> OK	AT+UCMGS="0171112233" „1,2,0,127<CR> > u-blox reserves all rights to this document and the information contained herein. Reproduction, use or disclosure to third parties without express permis<Ctrl-Z> +UCMGS:2 OK AT+UCMGS="0171112233" „2,2,0,127<CR> > sion is strictly prohibited.<Ctrl-Z> +UCMGS:3 OK
Test	AT+UCMGS=?	OK	

10.21.3 Defined values

Parameter	Type	Description
<da>	String	Destination address
<toda>	Number	Type of address of <da> - octet
<seq>	Number	Sequence number of the current short message (1-255)
<max>	Number	Maximum number of short messages in the concatenated short message (1-255)
<iei>	Number	Information Element Identifier, the possible values are the following: <ul style="list-style-type: none"> • 0: Concatenated short messages, 8-bit reference number • 8: Concatenated short messages, 16-bit reference number
<ref>	Number	Concatenated short message reference number: <ul style="list-style-type: none"> • 0-255: Concatenated short messages, 8-bit reference number case • 0-65535: Concatenated short messages, 16-bit reference number case
<text>	String	SMS String
<mr>	Number	Message reference

10.22 Write concatenated message to memory +UCMGW

+UCMGW						
Modules	LEON-G SARA-G					
Attributes	Syntax	PIN required	Settings saved	Can be aborted	Response time	Error reference
	full	Yes	No	No	< 10 s	+CMS Error

10.22.1 Description

Stores one segment of a concatenated message (SMS-DELIVER or SMS-SUBMIT) to memory storage <mem2> and returns the memory location <index> of the stored message. <Ctrl-Z> indicates that the SMS shall be stored, while <ESC> indicates aborting of the edited SMS.

 The command is supported only for text mode (+CMGF=1)

 The entered text is preceded by a ">" (Greater-Than sign) character, and this indicates that the interface is in "text enter" mode. The DCD signal shall be in ON state while the text is entered.

10.22.2 Syntax

Type	Syntax	Response	Example
Set	AT+UCMGW=[<oa/da>],[<tooa/toda>],[<stat>],[<seq>,<max>,<iei>,<ref><CR> text is entered<Ctrl-Z/ESC>	+UCMGW: <index> OK	AT+UCMGW="091137880" ,,,1,2,8, 32767<CR> > u-blox reserves all rights to this document and the information contained herein. Reproduction, use or disclosure to third parties without express permi<Ctrl-Z> +UCMGW:302 OK AT+UCMGW="091137880" ,,,2,2,8, 32767<CR> > sson is strictly prohibited.<Ctrl-Z> +UCMGW:303 OK
Test	AT+UCMGW=?	OK	

10.22.3 Defined values

Parameter	Type	Description
<da>	String	3GPP TS 23.040 [8] TP-Destination-Address Address-Value field in string format; BCD numbers (or GSM 7 bit default alphabet characters) are converted to characters of the currently selected TE character set (refer command +CSCS in 3GPP TS 27.007 [2]); type of address given by <toda>
<oa>	String	3GPP TS 23.040 [8] TP-Originating-Address Address-Value field in string format; BCD numbers (or GSM 7 bit default alphabet characters) are converted to characters of the currently selected TE character set (refer command +CSCS chapter Chapter 4.10); type of address given by <tooa>
<tooa>	Number	3GPP TS 24.011 [13] TP-Originating-Address Type-of-Address octet in integer format (default refer <toda>)
<toda>	Number	3GPP TS 24.011 [13] TP-Destination-Address Type-of-Address octet in integer format (when first character of <da> is + (IRA 43) default is 145, otherwise default is 129)
<stat>	String	Indicates the status of message in memory: <ul style="list-style-type: none"> • "REC UNREAD": received unread SMS messages • "REC READ": received read SMS messages • "STO UNSENT": stored unsent SMS messages • "STO SENT": stored sent SMS messages (default value)
<seq>	Number	Sequence number of the current short message (1-255)
<max>	Number	Maximum number of short messages in the concatenated short message (1-255)
<iei>	Number	Information Element Identifier, the possible values are the following: <ul style="list-style-type: none"> • 0: Concatenated short messages, 8-bit reference number • 8: Concatenated short messages, 16-bit reference number
<ref>	Number	Concatenated short message reference number: <ul style="list-style-type: none"> • 0-255: Concatenated short messages, 8-bit reference number case • 0-65535: Concatenated short messages, 16-bit reference number case
<text>	String	SMS String
<index>	Number	Storage position

10.23 More Messages to Send +CMMS

+CMMS						
Modules	LISA-U SARA-U					
Attributes	Syntax	PIN required	Settings saved	Can be aborted	Response time	Error reference
	full	Yes	No	No	-	+CMS Error

10.23.1 Description

Controls the continuity of SMS relay protocol link. When enabled, multiple SMS messages can be sent much faster as link is kept open.

10.23.2 Syntax

Type	Syntax	Response	Example
Set	AT+CMMS=[<mode>]	OK	AT+CMMS=2 OK
Read	AT+CMMS?	+CMMS: <mode> OK	+CMMS: 2 OK
Test	AT+CMMS=?	+CMMS: (list of supported <mode>s) OK	+CMMS: (0-2) OK

10.23.3 Defined values

Parameter	Type	Description
<mode>	Number	<ul style="list-style-type: none"> 0: disable (default) 1: keep enabled until the time between the response of the latest message send command (such as +CMGS) and the next send command exceeds 5 seconds, then close the link and switch <mode> automatically back to 0 2: keep permanently enabled. The link is closed after each send sequence, but <mode> is not switched back to 0

10.24 Peek message +UCMGP

+UCMGP						
Modules	LISA-U200-01S LISA-U200-02S LISA-U200-52S LISA-U200-62S LISA-U200-82S LISA-U230 LISA-U260 LISA-U270 SARA-U					
Attributes	Syntax	PIN required	Settings saved	Can be aborted	Response time	Error reference
	full	Yes	No	No	Up to 3 min (<1 s for prompt ">" when present)	+CMS Error

10.24.1 Description

Returns the message with location value <index> from message storage <mem1> to the DTE, the same as +CMGR does.

The SMS message is only 'peeked', i.e. its status is not forced to "received read SMS mode" after reading.

The syntax, defined values and remarks are the same as described for +CMGR.

 The PIN verification is not required when the preferred memory storage is "ME".

10.24.2 Syntax

Type	Syntax	Response	Example
Set	Text mode (+CMGF=1): AT+UCMGP=<index>	(SMS-DELIVER) +UCMGP: <stat>,<oa>,[<alpha>], <scts>[,<tooa>,<fo>,<pid>,<dc>,<sc>], <tosca>,<length> <data>	AT+UCMGP=303 +UCMGP: "REC UNREAD", "+393488535999",,"07/04/05,18:0 2:28+08",145,4,0,0,"+393492000466", 145,93



Type	Syntax	Response	Example
		OK	You have a missed called. Free information provided by your operator.
		(SMS-SUBMIT)	
		+UCMGP: <stat>,<da>,[<alpha>] [<toda>,<fo>,<pid>,<dcs>,[<vp>],<sca>,<tosca>,<length>] <data>	OK
		OK	
		(SMS-STATUS-report)	
		+UCMGP: <stat>,<fo>,<mr>,[<ra>],<tora> >]<sects><dt>,<st>	
		OK	
		(SMS-COMMAND)	
		+UCMGP: <stat>,<fo>,<ct>[,<pid>,<mn>],[<da>],[<toda>],<length> [<cdata>]]	
		OK	
		(CBM storage)	
		+UCMGP: <stat>,<sn>,<mid>,<dcs>,<page>,<pages> <data>	
		OK	
PDU mode (+CMGF=0):		+UCMGP: <stat>,[<alpha>],<length>	AT+UCMGP=1
AT+UCMGP=<index>		<pdu>	+CMGR: 0,,40 0791934329002000040C9193230982 661400008070328045218018D4F29CF E06B5CBF379F87C4EBF41E434082E7F DBC3 OK
Test	AT+UCMGP=?	OK	

10.24.3 Defined values

Parameter	Type	Description
<index>	Number	Storage position

10.25 Message Waiting Indication +UMWI

+UMWI									
Modules	LISA-U200-01S	LISA-U200-02S	LISA-U200-52S	LISA-U200-62S	LISA-U200-82S	LISA-U230	LISA-U260	LISA-U270	SARA-U
Attributes	Syntax	PIN required	Settings saved	Can be aborted	Response time	Error reference			
	full	No	No	No	-	-			

10.25.1 Description

Provides information regarding MWI third level method (3GPP defined in 3GPP TS 23.040 [8]) and CPHS method [66] following AT&T Device Requirements [61].

The set command enables / disables the URCs presentation. The URCs are enabled by factory default.

MWI is based on specific EFs not present in all SIM cards. In case these EFs are not present, the set command response is an error message ("CME ERROR: operation not allowed" if +CMEE is set to 2) and no URCs will be displayed.

 The URCs are displayed in groups of variable number which depends on the EFs present in the SIM card 3GPP TS 31.102 [19] and Common PCN Handset Specification [66].

10.25.2 Syntax

Type	Syntax	Response	Example
Set	AT+UMWI=<mode>	OK	AT+UMWI=1 OK
Read	AT+UMWI?	+UMWI: <mode>,<status>,<type>[,<count>] [+UMWI: <mode>,<status>,<type>[,<count>][...]] OK	+UMWI: 1,0,1 +UMWI: 1,0,2 +UMWI: 1,1,3,255 +UMWI: 1,0,4 OK
Test	AT+UMWI=?	+UMWI: (list of supported <mode>'s), OK	+UMWI: (0-1) OK
URC		+UMWI: <status>,<type>[,<count>] [+UMWI: <status>,<type>[,<count>][...]]	+UMWI: 1,1,3 +UMWI: 1,2,5 +UMWI: 1,3,255 +UMWI: 0,4

10.25.3 Defined values

Parameter	Type	Description
<mode>	Number	Indicates whether the MWI URC is enabled or not: <ul style="list-style-type: none"> • 0: disable Message Waiting Indication URC • 1 (factory-programmed setting): enable Message Waiting Indication URC
<status>	Number	Indicator status for the respective <type>: <ul style="list-style-type: none"> • 0: clear; no messages waiting • 1: set; messages waiting
<type>	Number	Indicates the basic message indication type: <ul style="list-style-type: none"> • 1: Voice Message Waiting (third level method) or Voice Message Waiting on Line 1 (CPHS method) • 2: Fax Message Waiting • 3: Electronic Mail Message Waiting • 4: Extended Message Type Waiting (i.e. refer to 3GPP TS 23.038 [7]) • 5: Video Message Waiting • 6: Voice Message Waiting on Line 2 (CPHS method) • 7: Reserved for future use
<count>	Number	Number of messages waiting for the respective <type>, range 1-255. 255 means that the number of waiting messages is unknown.

10.25.4 Notes

- If <status>=0, <count> is omitted.

11. Supplementary services

11.1 Call forwarding +CCFC

+CCFC						
Modules	LEON-G SARA-G					
	LISA-U SARA-U					
Attributes	Syntax	PIN required	Settings saved	Can be aborted	Response time	Error reference
	full	Yes	No	Yes	<i>Up to 3 min</i>	<i>+CME Error</i>

11.1.1 Description

Controls the call forwarding supplementary service. Registration, erasure, activation, deactivation and status query are supported. This command can be aborted.

11.1.2 Syntax

Type	Syntax	Response	Example
Set	AT+CCFC=<reason>,<mode>[,<number>[,<type>[,<class>[,<subaddr>[,<satype>[,<time>]]]]]]	OK or when <mode>=2	Registration: AT+CCFC=0,3,"01711234" OK
		+CCFC: <status>,<class1>[,<number>,<type> [,<subaddr>, <satype>[,<time>]]]	Query status: AT+CCFC=2,2
		[+CCFC: <status>,<class2> [,<number>,<type>[,<subaddr>,<satype>[,<time>]]]	+CCFC: 1,1,"+3945112",145,"",,60 OK
Test	AT+CCFC=?	+CCFC: (list of supported <reason>s) OK	+CCFC: (0-5) OK

11.1.3 Defined values

Parameter	Type	Description
<reason>	Number	<ul style="list-style-type: none"> 0: unconditional 1: mobile busy 2: no reply 3: not reachable 4: all call forwarding 5: all conditional call forwarding
<mode>	Number	<ul style="list-style-type: none"> 0: disable 1: enable 2: query status 3: registration 4: erasure
<number>	String	Phone number of forwarding address in <type> format
<type>	Number	Type of address; default 145 when dialling string includes '+', otherwise 129
<subaddr>	String	Subaddress; parameter currently ignored after syntax check
<satype>	Number	Type of subaddress; default 128 (TON/NPI unknown); parameter currently ignored after syntax check
<classx>	Number	Sum of Numbers each representing a class of information (default 7 - voice (1), data (2) and FAX (4) - or interpreted by network if not explicitly entered) <ul style="list-style-type: none"> 1: voice 2: data 4: FAX 8: SMS 16: data circuit sync 32: data circuit async

Parameter	Type	Description
		<ul style="list-style-type: none"> 64: dedicated packet access 128: dedicated PAD access
<time>	Number	Time in seconds to wait before call is forwarded (default 60), but only when <reason>=2 (no reply) is enabled; the range goes from 5 to 30 s
<status>	Number	<ul style="list-style-type: none"> 0: not active 1: active

11.2 Call waiting +CCWA

+CCWA						
Modules	LEON-G SARA-G					
	LISA-U SARA-U					
Attributes	Syntax	PIN required	Settings saved	Can be aborted	Response time	Error reference
	partial	Yes	No	Yes	Up to 3 min	+CME Error

11.2.1 Description

Controls the Call Waiting supplementary service according to 3GPP TS 22.083 [33]. The activation, deactivation and status query are supported. When querying the status of a network service (<mode>=2) the response line for 'not active' case (<status>=0) should be returned only if service is not active for any <class>. It is possible to abort the status query sending a character to the DCE during the command execution. If enabled by <n> a URC is presented on TE when a call is signaled.

11.2.2 Syntax

Type	Syntax	Response	Example
Set	Set Command	Set Command	Set command
	AT+CCWA=[<n>[,<mode>[,<class>]]]	OK	AT+CCWA=1,1,32
	Query Command	Query Command	OK
	AT+CCWA=[<n>[,<mode>]]	+CCWA: <status>,<class1> [+CCWA: <status>,<class2> [...]] OK	Query Command AT+CCWA=1,2 +CCWA: 1,1 +CCWA: 1,4 +CCWA: 1,16 +CCWA: 1,32 OK
Read	AT+CCWA?	+CCWA: <n> OK	+CCWA: 0 OK
Test	AT+CCWA=?	+CCWA: (list of supported <n>s) OK	+CCWA: (0-1) OK
URC		+CCWA: <number>,<type>,<class>, [<alpha>][,<CLI validity>[,<subaddr>, <satype>[,<priority>]]]	

11.2.3 Defined values

Parameter	Type	Description
<n>	Number	Enable/disable the URC +CCWA <ul style="list-style-type: none"> 0: disable 1: enable
<mode>	Number	If <mode> is not set, none request is sent to the network <ul style="list-style-type: none"> 0: disable 1: enable 2: query status
<classx>	Number	Sum of numbers each representing an information class:

Parameter	Type	Description
		<ul style="list-style-type: none"> If <classx> is not set and <mode> is 0 or 1 the default value is 3 The default value is 255 if <classx> is not set and <mode> is 2 e.g. it reports all active classes if any. If no class is active only classes 1 and 2 are reported as inactive: +CCWA: 0,1 +CCWA: 0,2 1: voice 2: data; it comprises all those <classx> values between 16 and 128, that are supported both by the network and the MS. This means, a setting made for <classx> to 2 applies to all remaining data classes (if supported). In addition, it is possible to assign a different setting to a specific class. For example, call waiting can be deactivated only for a specific data class. To understand which classes were actually activated AT+CCWA=1,2 command should be executed 4: FAX 8: SMS 16: data circuit sync 32: data circuit async 64: dedicated packet access 128: dedicated PAD access
<status>	Number	<ul style="list-style-type: none"> 0: not active 1: active
<number>	String	Phone number of calling address in format specified by <type>
<type>	Number	Type of address
<alpha>	String	Optional string type alphanumeric representation of <number> corresponding to the entry found in phonebook; this parameter is not managed
<CLI validity>	Number	<ul style="list-style-type: none"> 0: CLI valid 1: CLI has been withheld by the originator 2: CLI is not available
<cause of no cli>	Number	<ul style="list-style-type: none"> 0: unavailable 1: reject by user 2: interaction with other service 3: coin line/payphone
<subaddr>	String	Subaddress of format specified by <satype>
<satype>	Number	Subaddress octet (refer to 3GPP TS 24.008 subclause 10.5.4.8 [30])
<priority>	Number	Optional digit type parameter indicating that the eMLPP priority level of the incoming call. The priority level values are as defined in eMLPP specification 3GPP TS 22.067 [59].

11.2.4 Notes

- The call waiting is not handled in uniform mode among all the networks, even if the GSM 02.04 [3] describes all needed specification: "The applicability of call waiting refers to the telecommunication service of the active call and not of the waiting call. The incoming, waiting, call may be of any kind." Nevertheless, the actual implementation of the service on the networks is different.
- If a sum class is provided in the <classx> parameter the classes will be activated or deactivated in cardinal order (minimum to maximum). If a class is not supported then the procedure ends and any remaining class is not processed. To check which classes were actually activated AT+CCWA=1,2 command should be done.

LEON-G / SARA-G

- If <classx> is not set and <mode> is 0 or 1 the default value is 1.
- if no class is active only class 1 is reported as inactive.

11.3 Calling line identification restriction +CLIR

+CLIR						
Modules	LEON-G SARA-G LISA-U SARA-U					
Attributes	Syntax	PIN required	Settings saved	Can be aborted	Response time	Error reference
	full	Yes	No	Yes	Up to 3 min (<1 s for prompt ">" when present)	+CME Error

11.3.1 Description

Controls calling line identification restriction supplementary service (3GPP 22.081 [34]).

11.3.2 Syntax

Type	Syntax	Response	Example
Set	AT+CLIR=[<n>]	OK	AT+CLIR=2 OK
Read	AT+CLIR?	+CLIR: <n>,<m> OK	+CLIR: 0,2 OK
Test	AT+CLIR=?	+CLIR: (list of supported <n>s) OK	+CLIR: (0-2) OK

11.3.3 Defined values

Parameter	Type	Description
<n>	Number	Sets the adjustment for outgoing calls <ul style="list-style-type: none"> 0: presentation indicator is used according to the subscription of the CLIR service 1: CLIR invocation 2: CLIR suppression
<m>	Number	Shows the subscriber CLIR status in the network <ul style="list-style-type: none"> 0: CLIR not provisioned 1: CLIR provisioned in permanent mode 2: unknown 3: CLIR temporary mode presentation restricted 4: CLIR temporary mode presentation allowed

11.4 Calling line identification presentation +CLIP

+CLIP						
Modules	LEON-G SARA-G LISA-U SARA-U					
Attributes	Syntax	PIN required	Settings saved	Can be aborted	Response time	Error reference
	full	Yes	No	Yes	Up to 3 min (<1 s for prompt ">" when present)	+CME Error

11.4.1 Description

Controls the calling line identification presentation supplementary service. When CLI (Calling Line Identification) is enabled, +CLIP response is returned after every RING result code. The URC is displayed after RING if the CLI presentation at the TE is enabled.

11.4.2 Syntax

Type	Syntax	Response	Example
Set	AT+CLIP=[<n>]	OK	AT+CLIP=1 OK

Type	Syntax	Response	Example
Read	AT+CLIP?	+CLIP: <n>,<m> OK	+CLIP: 0,2 OK
Test	AT+CLIP=?	+CLIP: (list of supported <n>s) OK	+CLIP: (0-1) OK
URC		+CLIP: <number>,<type>[,<subaddr>,<satype>[,<alpha>[,<CLI validity>]]]	

11.4.3 Defined values

Parameter	Type	Description
<n>	Number	Optional parameter sets/shows the result code presentation in the TA <ul style="list-style-type: none"> 0: disable (default value) 1: enable
<m>	Number	Shows the subscriber CLIP service status in the network <ul style="list-style-type: none"> 0: CLIP not provisioned 1: CLIP provisioned 2: unknown
<number>	String	Phone number of calling address in format specified by <type>
<type>	Number	Type of address octet
<subaddr>	String	Subaddress of format specified by <satype>
<satype>	Number	Type of subaddress octet
<alpha>	String	Optional string type alphanumeric representation of <number> corresponding to the entry found in phonebook; parameter is not managed
<CLI validity>	Number	<ul style="list-style-type: none"> 0: CLI valid 1: CLI has been withheld by the originator 2: CLI is not available

11.4.4 Notes

- When CLI is not available (<CLI validity>=2), <number> shall be an empty string ("") and <type> value will not be significant. Nevertheless, TA may return the recommended value 128 for <type> ((TON/NPI unknown). When CLI has been withheld by the originator, (<CLI validity>=1) and the CLIP is provisioned with the "override category" option (refer to 3GPP TS 22.081 [34] and 3GPP TS 23.081 [35]), <number> and <type> is provided. Otherwise, TA shall return the same setting for <number> and <type> as if the CLI was not available.

11.5 Connected line identification presentation +COLP

+COLP						
Modules	LEON-G SARA-G					
	LISA-U SARA-U					
Attributes	Syntax	PIN required	Settings saved	Can be aborted	Response time	Error reference
	full	Yes	No	Yes	< 20 s	+CME Error

11.5.1 Description

Controls the connected line identification presentation supplementary service (refer to 3GPP TS 22.081 [34]), useful in case of call forwarding of the connected line. It enables a calling subscriber to get the connected line identity (COL) of the called party, after setting up a mobile originated call. The command enables or disables the presentation of the COL at the TE. It has no effect on the execution of the supplementary service COLR in the network.

When enabled (and called subscriber allows), the intermediate result code is sent from TA to TE before any +CR or V.25ter responses.

Read command provides the status of <n>, and also triggers an interrogation of the provision status of the COLP service according 3GPP TS 22.081 [34] (given in <m>).

11.5.2 Syntax

Type	Syntax	Response	Example
Set	AT+COLP=[<n>]	OK	AT+COLP=1 OK
Read	AT+COLP?	+COLP: <n>,<m> OK	+COLP: 0,2 OK
Test	AT+COLP=?	+COLP: (list of supported <n>s) OK	+COLP: (0-1) OK
IRC		+COLP: <number>,<type>[,<subaddr>,<satype>[,<alpha>]]	

11.5.3 Defined values

Parameter	Type	Description
<n>	Number	Optional parameter sets/shows the result code presentation status to the TE <ul style="list-style-type: none"> 0: disable (default value) 1: enable
<m>	Number	Shows the subscriber COLP status in the network <ul style="list-style-type: none"> 0: COLP not provisioned 1: COLP provisioned 2: unknown (e.g. no network, etc.)
<number>, <type>,<subaddr>,<satype>,<alpha>		See +CLIP (Chapter 11.4)

11.6 Connected line identification restriction +COLR

+COLR						
Modules	LEON-G SARA-G LISA-U SARA-U					
Attributes	Syntax	PIN required	Settings saved	Can be aborted	Response time	Error reference
	full	Yes	No	Yes	< 20 s	+CME Error

11.6.1 Description

Enables the connected party to prevent presentation of its line identity to the calling party. According to GSM0 2.81 [34] the activation and deactivation of COLR is only a result of provision / withdrawal. The command +COLR allows only the interrogation of the current state of COLR service in the network. The set syntax is not allowed (+CME ERROR: operation not supported).

11.6.2 Syntax

Type	Syntax	Response	Example
Read	AT+COLR?	+COLR: <status> OK	+COLR: 2 OK
Test	AT+COLR=?	OK	

11.6.3 Defined values

Parameter	Type	Description
<status>	Number	Shows the subscriber COLR service status in the network <ul style="list-style-type: none"> 0: COLR not provisioned 1: COLR provisioned 2: unknown

11.7 Advice of charge +CAOC

+CAOC						
Modules	LEON-G SARA-G					
	LISA-U SARA-U					
Attributes	Syntax	PIN required	Settings saved	Can be aborted	Response time	Error reference
	partial	Yes	No	No	< 10 s	+CME Error

11.7.1 Description

Allows the subscriber to get the information about the call costs in home units using the advice of charge supplementary service (3GPP TS 22.024 [37] and 3GPP TS 22.086 [36]). If it is enabled, the TE periodically receives the URC containing the corresponding information.

11.7.2 Syntax

Type	Syntax	Response	Example
Set	AT+CAOC[=<mode>]	[+CAOC: <ccm>] OK	AT+CAOC=0 OK
Read	AT+CAOC?	+CAOC: <mode> OK	+CAOC: 1 OK
Test	AT+CAOC=?	+CAOC: (list of supported <mode>s) OK	+CAOC: (0-2) OK
URC		+CCCM: <ccm>	

11.7.3 Defined values

Parameter	Type	Description
<mode>	Number	<ul style="list-style-type: none"> 0: queries the CCM value 1: deactivates the unsolicited reporting of CCM value 2: activates the unsolicited reporting of CCM value
<ccm>	Number	Current call meter indicated as a string in hexadecimal format

11.7.4 Notes

LEON-G100-06S / LISA-U1 / LISA-U2x0-x1S

- If the SIM card does not support the AoC, the CCM value is not updated and no URC is displayed.

11.8 Accumulated call meter +CACM

+CACM						
Modules	LEON-G SARA-G					
	LISA-U SARA-U					
Attributes	Syntax	PIN required	Settings saved	Can be aborted	Response time	Error reference
	full	No	No	No	< 10 s	+CME Error

11.8.1 Description

Resets the advice of charge related accumulated call meter value in the SIM file EF_{ACM}. The ACM contains the total number of home units for both the current and preceding calls. The SIM PIN2 is required to reset the value.



If the EF is not available, the read command returns +CME ERROR: SIM failure (verbose result code).

11.8.2 Syntax

Type	Syntax	Response	Example
Set	AT+CACM=[<passwd>]	OK	AT+CACM="0933" OK

Type	Syntax	Response	Example
Read	AT+CACM?	+CACM: <acm> OK	+CACM: "000000" OK
Test	AT+CACM=?	OK	

11.8.3 Defined values

Parameter	Type	Description
<passwd>	String	SIM PIN2 as string type
<acm>	String	Accumulated call meter value similarly coded as <ccm> under <i>+CAOC</i>

11.8.4 Notes

- The command needs the SIM module to work correctly

11.9 Accumulated call meter maximum +CAMM

+CAMM						
Modules	LEON-G SARA-G					
	LISA-U SARA-U					
Attributes	Syntax	PIN required	Settings saved	Can be aborted	Response time	Error reference
	full	No	No	No	< 10 s	+CME Error

11.9.1 Description

Sets the advice of charge related accumulated call meter maximum value in the SIM file EF_{ACMmax}. The ACMmax contains the maximum number of home units allowed to be consumed by the subscriber. When the ACM reaches ACMmax, the calls are prohibited. The SIM PIN2 is required to set the value.



If the EF is not available, the read command returns +CME ERROR: SIM failure (verbose result code).

11.9.2 Syntax

Type	Syntax	Response	Example
Set	AT+CAMM=[<acmmax>[,<passwd>]]	OK	AT+CAMM="000300","0933" OK
Read	AT+CAMM?	+CAMM: <acmmax> OK	+CAMM: "000300" OK
Test	AT+CAMM=?	OK	

11.9.3 Defined values

Parameter	Type	Description
<acmmax>	String	Contains the accumulated call meter maximum value similarly coded as <ccm> under <i>+CAOC</i> ; value zero disables the ACMmax feature
<passwd>	String	Contains SIM PIN2

11.9.4 Notes

- The command needs the SIM module to work correctly

11.10 Price per unit and currency table +CPUC

+CPUC						
Modules	LEON-G SARA-G					
	LISA-U SARA-U					
Attributes	Syntax	PIN required	Settings saved	Can be aborted	Response time	Error reference
	full	No	No	No	< 10 s	+CME Error

11.10.1 Description

Sets the parameters of advice of charge related price per unit and the currency table in the SIM file EF_{PUCT}. The PUCT information can be used to convert the home units into the currency units. The PIN2 is required to set the parameters.



If the EF is not available, the read command returns +CME ERROR: SIM failure (verbose result code).

11.10.2 Syntax

Type	Syntax	Response	Example
Set	AT+CPUC=<currency>,<ppu>[,<passwd>]	OK	AT+CPUC="USD","0.20","0933" OK
Read	AT+CPUC?	+CPUC: <currency>,<ppu> OK	+CPUC: "USD","0.20" OK
Test	AT+CPUC=?	OK	

11.10.3 Defined values

Parameter	Type	Description
<currency>	String	Contains the three-character currency code (e.g. "GBP", "EUR")
<ppu>	String	Contains the price per unit; the dot is used as a decimal separator
<passwd>	String	Contains SIM PIN2

11.11 Call related supplementary services +CHLD

+CHLD						
Modules	LEON-G SARA-G					
	LISA-U SARA-U					
Attributes	Syntax	PIN required	Settings saved	Can be aborted	Response time	Error reference
	partial	Yes	No	No	< 20 s	+CME Error

11.11.1 Description

Call hold and multiparty conversation (conference call). The calls can be put on hold, recovered, released or added to the conversation.

11.11.2 Syntax

Type	Syntax	Response	Example
Set	AT+CHLD=[<n>]	OK	AT+CHLD=2 OK
Test	AT+CHLD=?	+CHLD: (list of supported <n>s) OK	+CHLD: (0,1,1x,2,2x,3,4,4*,6,7,8) OK

11.11.3 Defined values

Parameter	Type	Description
<n>	Number	<ul style="list-style-type: none"> 0: release all the held calls or set User Determined User Busy for a waiting call; if both exists then only the waiting call will be rejected 1: release all the active calls and accepts the other (held or waiting)

Parameter	Type	Description
		<ul style="list-style-type: none"> 1x: release a specific call (x specific call number as indicated by +CLCC - Chapter 11.13) 2: place all the active calls (if exist) on hold and accepts the other call (held or waiting, if exist) 2x: place all the active calls on hold except the call x with which communication is supported 3: adds a held call to the conversation 4: connects the two calls and disconnects the subscriber from both calls (Explicit Call Transfer) 4*: call deflection (proprietary feature) 5: call completion of busy subscriber; this command syntax will be interpreted as an activation request, if the network has previously offered the possibility to activate this function 6: puts an active call on hold or an held call to active, while another call is waiting 7: disconnect the users in multiparty without accepting incoming call 8: release all the calls (active and held)

11.11.4 Notes

LEON-G100-06S

- In the set command the '=' character is not mandatory.

11.12 Call deflection +CTFR

+CTFR						
Modules	LEON-G SARA-G					
	LISA-U SARA-U					
Attributes	Syntax	PIN required	Settings saved	Can be aborted	Response time	Error reference
	full	Yes	No	No	Up to 3 min	+CME Error

11.12.1 Description

Allows the MT user to respond to an incoming call offered by the network by requesting call deflection, i.e. redirection of this call to another number specified in the response. The call deflection is a supplementary service applicable only to voice calls (teleservice 11).

11.12.2 Syntax

Type	Syntax	Response	Example
Set	AT+CTFR=<number>	OK	AT+CTFR="09113788" OK
Test	AT+CTFR=?	OK	

11.12.3 Defined values

Parameter	Type	Description
<number>	String	Phone number

11.13 List current calls +CLCC

+CLCC						
Modules	LEON-G SARA-G					
	LISA-U SARA-U					
Attributes	Syntax	PIN required	Settings saved	Can be aborted	Response time	Error reference
	full	Yes	No	No	-	+CME Error

11.13.1 Description

Returns the list of current calls of MT. If no calls are available, no information text response is sent.

11.13.2 Syntax

Type	Syntax	Response	Example
Action	AT+CLCC	[+CLCC: <id1>,<dir>,<stat>,<mode>,<mpty>[,<number>,<type>[,<alpha>]] [+CLCC: <id2>,<dir>,<stat>,<mode>,<mpty>[,<number>,<type>[,<alpha>]] [...]] OK or OK (if no calls)	+CLCC: 1,0,0,0,0,"0913137880",129 OK
Test	AT+CLCC=?	OK	

11.13.3 Defined values

Parameter	Type	Description
<idx>	Number	Indicates the call identification (see +CHLD x)
<dir>	Number	Direction <ul style="list-style-type: none"> • 0: mobile originated (MO) call • 1: mobile terminated (MT) call
<stat>	Number	State of the call <ul style="list-style-type: none"> • 0: active • 1: held • 2: dialling (Mobile Originated call) • 3: alerting (Mobile Originated call) • 4: incoming (Mobile Terminated call) • 5: waiting (Mobile Terminated call)
<mode>	Number	Teleservice <ul style="list-style-type: none"> • 0: voice • 1: data • 2: FAX • 9: unknown
<mpty>	Number	<ul style="list-style-type: none"> • 0: call is not one of multiparty (conference) call parties • 1: call is one of multiparty call parties
<number>	String	Indicates the phone number in format specified by <type>
<type>	Number	Type of address octet (phone number)
<alpha>	String	Optional string alphanumeric representation of <number> corresponding to the entry found in phonebook; this parameter is not managed

11.14 Supplementary service notifications +CSSN

+CSSN						
Modules	LEON-G SARA-G LISA-U SARA-U					
Attributes	Syntax	PIN required	Settings saved	Can be aborted	Response time	Error reference
	full	No	No	No	-	+CME Error

11.14.1 Description

Refers to supplementary service related network initiated notifications. When <n>=1 and a supplementary service notification is received after a mobile originated call setup, the IRC is sent before any other Mobile Originated call setup result codes. When <m>=1 and a supplementary service notification is received during a call, the URC is sent.

11.14.2 Syntax

Type	Syntax	Response	Example
Set	AT+CSSN=[<n>[,<m>]]	OK	AT+CSSN=0,0 OK
Read	AT+CSSN?	+CSSN: <n>,<m> OK	+CSSN: 0,0 OK
Test	AT+CSSN=?	+CSSN: (list of supported <n>s),(list of supported <m>s) OK	+CSSN: (0-1),(0-1) OK
IRC		+CSSI: <code1>[,<index>]	+CSSI: 4,1
URC		+CSSU: <code2>[,<index>[,<number>,<type>[,<subaddr>,<satype>]]]	+CSSU: 0

11.14.3 Defined values

Parameter	Type	Description
<n>	Number	Sets/shows the +CSSI result code presentation status <ul style="list-style-type: none"> • 0: disabled (default value) • 1: enabled
<m>	Number	Sets/shows the +CSSU result code presentation status <ul style="list-style-type: none"> • 0: disabled (default value) • 1: enabled
<code1>	Number	<ul style="list-style-type: none"> • 0: unconditional call forwarding is active • 1: some of the conditional call forwardings are active • 2: call has been forwarded • 3: call is waiting • 4: this is a CUG call (<index> parameter is provided) • 5: outgoing calls are barred • 6: incoming calls are barred • 7: CLIR suppression rejected • 8: calls has been deflected
<index>	Number	Refer +CCUG (Chapter 11.17)
<code2>	Number	<ul style="list-style-type: none"> • 0: this is a forwarded call (MT call setup) • 1: this is a CUG call (<index> parameter is provided) (MT call setup) • 2: call has been put on hold (during a voice call) • 3: call has been retrieved (during a voice call) • 4: multiparty call entered (during a voice call) • 5: call on hold has been released - this is not an SS notification - (during a voice call) • 6: forward check SS message received (can be received whenever) • 7: call is being connected (alerting) with the remote party in alerting state in explicit call transfer operation (during a voice call) • 8: call has been connected with the other remote party in explicit call transfer operation (during a voice call or MT call setup) • 9: this is a deflected call (MT call setup) • 10: additional incoming call forwarded
<number>	String	Phone number, format specified by <type>
<type>	Number	Type of address octet
<subaddr>, <satype>	String	Not used

11.15 User to user signalling service 1 +CUUS1

+CUUS1						
Modules	LEON-G SARA-G					
Attributes	Syntax	PIN required	Settings saved	Can be aborted	Response time	Error reference
	full	Yes	No	No	-	+CME Error

11.15.1 Description

Allows the control of the User-to-User Signalling Supplementary Service 1 (UUS1) according to 3GPP TS 22.087 [29]. Parameters <message> and <UUIE> are used to activate/deactivate the implicit request of the User-to-User Signalling Supplementary Service 1. When <message> and <UUIE> are both present the string specified in <UUIE> is included as the value part of the User-to-User Information Element (as defined in 3GPP TS 24.008 [30]) into all subsequent messages of type <message>. If parameter <message> is present but parameter <UUIE> is not present then the User-to-User Information Element shall not be present in subsequent messages of type <message>.

<n> and <m> parameters are used to enable/disable the presentation of incoming User-to-User Information Elements. When <n>=1 and a User-to-User Information is received after a mobile originated call setup or after hanging up a call, IRC +CUUS1I: <message>,<UUIE> is sent to the DTE.

When <m>=1 and a User-to-User Information is received during a mobile terminated call setup or during a remote party call hangup, URC +CUUS1U: <messageU>,<UUIE> is sent to the DTE.

11.15.2 Syntax

Type	Syntax	Response	Example
Set	AT+CUUS1=[<n>[,<m>[,<message>[,<UUIE>[,<message>[,<UUIE>[...]]]]]]]	OK	AT+CUUS1=1,1,1,"7E0005123456" OK
Read	AT+CUUS1?	+CUUS1: <n>,<m>[,<message>,<UUIE>[,<message>,<UUIE>[...]]] OK	+CUUS1: 0,0 OK
Test	AT+CUUS1=?	+CUUS1: (list of supported <n>s), (list of supported <m>s), (list of supported <message>s), (list of supported <messageI>s), (list of supported <messageU>s) OK	+CUUS1: (0,1),(0,1),(0-6),(0-4),(0-3) OK
IRC		+CUUS1I: <messageI>,<UUIE>	
URC		+CUUS1U: <messageU>,<UUIE>	

11.15.3 Defined values

Parameter	Type	Description
<n>	Number	Sets/shows the +CUUS1I result code presentation status in the MT <ul style="list-style-type: none"> • 0: disable • 1: enable
<m>	Number	Sets/shows the +CUUS1U result code presentation status in MT <ul style="list-style-type: none"> • 0: disable • 1: enable
<message>	Number	Type of message containing the outgoing User-to-User Information Element <ul style="list-style-type: none"> • 0: ANY • 1: SETUP • 2: ALERT • 3: CONNECT • 4: DISCONNECT • 5: RELEASE • 6: RELEASE_COMPLETE

Parameter	Type	Description
<messageI>	Number	Type of message containing the intermediate User-to-User Information Element <ul style="list-style-type: none"> 0: ANY 1: ALERT 2: PROGRESS 3: CONNECT (sent after +COLP if enabled) 4: RELEASE
<messageU>	Number	Type of message containing the unsolicited User-to-User Information Element <ul style="list-style-type: none"> 0: ANY 1: SETUP (returned after +CLIP if presented, otherwise after every RING or +CRING (refer to +CRC)) 2: DISCONNECT 3: RELEASE_COMPLETE
<UUIE>	Number	The User-to-User Information Element (as defined in 3GPP TS 24.008 [12]) in hexadecimal character format (for hexadecimal format, refer to +CSCS).

11.15.4 Notes

- If the MT does not distinguish the type of message containing the User-to-User Information Element, it can use the value for ANY message.

11.16 Unstructured supplementary service data +CUSD

+CUSD						
Modules	LEON-G SARA-G LISA-U SARA-U					
Attributes	Syntax	PIN required	Settings saved	Can be aborted	Response time	Error reference
	full	Yes	No	Yes	Up to 3 min	+CME Error

11.16.1 Description

Control of Unstructured Supplementary Service Data (USSD) is according to 3GPP TS 22.090 [6]. Both network and mobile initiated operations are supported. The parameter <n> is used to disable/enable the URC presentation. Value <n>=2 is used to cancel an ongoing USSD session. This command can be aborted. When <str> is given, a mobile initiated USSD-string or a response USSD-string to a network initiated operation is sent to the network. The response USSD-string from the network is returned in the URC +CUSD indicated above.



The command to abort is equivalent to send AT+CUSD=2, that ends the current USSD session.



After having sent a +CUSD request it is not possible to send another one until the URC of the first one is not received.



Do not send new +CUSD requests when the URC, result of the previous request, has not been received yet.

11.16.2 Syntax

Type	Syntax	Response	Example
Set	AT+CUSD=[<n>,<str>,<dcs>]]	[+CUSD: <m>,<str>,<dcs>]] OK	AT+CUSD=1,"*100#",15 +CUSD: 2,"Residual credit: 7,87 Euro", 15 OK
Read	AT+CUSD?	+CUSD: <n> OK	+CUSD: 0 OK
Test	AT+CUSD=?	+CUSD: (list of supported <n>s) OK	+CUSD: (0-2) OK
URC		+CUSD: <m>,<str>,<dcs>]	

11.16.3 Defined values

Parameter	Type	Description
<n>	Number	<ul style="list-style-type: none"> 0: disable the result code presentation 1: enable the result code presentation 2: cancel session (not applicable to read command response)
<str>	String	USSD-string converted in the current character set in use (refer to +CSCS command)
<dcs>	Number	Data coding scheme (see 3GPP TS 23.038 [7]) used for sending the USSD string. 1 byte in decimal format; valid values are 0-255. The default value is 15.
<m>	Number	<ul style="list-style-type: none"> 0: no further user action required 1: further user action required 2: USSD termination by network 4: operation not supported 5: network time out

11.17 Closed user group +CCUG

+CCUG						
Modules	LEON-G SARA-G LISA-U SARA-U					
Attributes	Syntax	PIN required	Settings saved	Can be aborted	Response time	Error reference
	full	Yes	No	No	-	+CME Error

11.17.1 Description

Enables subscribers to form closed user groups to and from which access is restricted (refer to 3GPP TS 22.085 [38]). The command can be used to:

- Activate/deactivate the control of the CUG information for all following calls
- Select a CUG index
- Suppress the outgoing access (OA). The OA allows a member of a CUG to place calls outside the CUG
- Suppress the preferential CUG

11.17.2 Syntax

Type	Syntax	Response	Example
Set	AT+CCUG=[<n>[,<index>[,<info>]]]	OK	AT+CCUG=1,2,1 OK
Read	AT+CCUG?	+CCUG: <n>,<index>,<info> OK	+CCUG: 0,0,0 OK
Test	AT+CCUG=?	+CCUG: (list of supported <n>s),(list of supported <index>s),(list of supported <info>s) OK	+CCUG: (0-1),(0-10),(0-3) OK

11.17.3 Defined values

Parameter	Type	Description
<n>	Number	<ul style="list-style-type: none"> 0: CUG temporary disabled (default value) 1: CUG temporary enabled
<index>	Number	<ul style="list-style-type: none"> 0..9: CUG index, (0 default value) 10: no index (preferred CUG taken from subscriber data)
<info>	Number	<ul style="list-style-type: none"> 0: no information (default value) 1: suppress OA 2: suppress preferential CUG 3: suppress OA and preferential CUG

11.18 Calling name presentation +CNAP

+CNAP						
Modules	LEON-G SARA-G LISA-U SARA-U					
Attributes	Syntax	PIN required	Settings saved	Can be aborted	Response time	Error reference
	full	Yes	No	Yes	< 20 s	+CME Error

11.18.1 Description

This command refers to the GSM/UMTS supplementary service CNAP (Calling Name Presentation, refer to 3GPP TS 22.096 [39]) that enables a called subscriber to get a calling name indication (CNI) of the calling party when receiving a mobile terminated call. The set command enables or disables the CNI presentation. It has no effect on the execution of the supplementary service CNAP in the network. When the presentation of the CNI is enabled (and CNI is provided), the URC +CNAP: <name>,<CNI_validity> response is returned.

11.18.2 Syntax

Type	Syntax	Response	Example
Set	AT+CNAP=[<n>]	OK	AT+CNAP=0 OK
Read	AT+CNAP?	+CNAP: <n>,<m> OK	+CNAP: 0,2 OK
Test	AT+CNAP=?	+CNAP: (list of supported <n>s) OK	+CNAP: (0-1) OK
URC		+CNAP: <calling_name>[,<CNI_validity>]	+CNAP: "SubscriberName",0

11.18.3 Defined values

Parameter	Type	Description
<n>	Number	Sets the result code presentation <ul style="list-style-type: none"> 0: disabled (default value) 1: enabled
<m>	Number	Subscriber CNAP service status in the network <ul style="list-style-type: none"> 0: CNAP not provisioned 1: CNAP provisioned 2: unknown
<calling_name>	String	Calling party name
<CNI_validity>	Number	<ul style="list-style-type: none"> 0: name presentation allowed 1: presentation restricted 2: name unavailable 3: name presentation restricted

12. Circuit switched data services

12.1 Introduction

For CSD services, it is advised to enable the XID negotiation using the configuration +CRLP=61,61,48,7.

12.2 Select bearer service type +CBST

+CBST						
Modules	LEON-G SARA-G LISA-U SARA-U					
Attributes	Syntax	PIN required	Settings saved	Can be aborted	Response time	Error reference
	partial	No	<i>Profile</i>	No	-	<i>+CME Error</i>

12.2.1 Description

Selects the bearer service <name> with data rate <speed> and the connection element <ce> to use for data calls.

12.2.2 Syntax

Type	Syntax	Response	Example
Set	AT+CBST=[<speed>[,<name>[,<ce>]]]	OK	AT+CBST=5,0,1 OK
Read	AT+CBST?	+CBST: <speed>,<name>,<ce> OK	+CBST: 14,0,1 OK
Test	AT+CBST=?	+CBST: (list of supported <speed>s),(list of supported <name>s),(list of supported <ce>s) OK	+CBST: (0,4-7,12,14-16,68,70-71,75,79-81,83-84,115-116,130-131,133-134),(0,1),(0-3) OK

12.2.3 Defined values

Parameter	Type	Description
<speed>	Number	<ul style="list-style-type: none"> 0: autobaoding 4: 2400 b/s (V.22bis) (RAT GSM only) 5: 2400 b/s (V.26ter) (RAT GSM only) 6: 4800 b/s (V.32) 7: 9600 b/s (V.32) 12: 9600 b/s (V.34) (Only for UMTS RAT) 14: 14400 b/s (V.34) (Only for UMTS RAT) 15: 19200 b/s (V.34) (Only for UMTS RAT) 16: 28800 b/s (V.34) (Only for UMTS RAT) 68: 2400 b/s (V110 or X.31 flag stuffing) (RAT GSM only) 70: 4800 b/s (V110 or X.31 flag stuffing) 71: 9600 b/s (V110 or X.31 flag stuffing) (default and factory-programmed value) 75: 14400 b/s (V110 or X.31 flag stuffing) (only for UMTS RAT) 79: 19200 b/s (V110 or X.31 flag stuffing) (only for UMTS RAT) 80: 28800 b/s (V110 or X.31 flag stuffing) (only for UMTS RAT) 81: 38400 b/s (V110 or X.31 flag stuffing) (only for UMTS RAT) 83: 56000 b/s (V110 or X.31 flag stuffing) (only for UMTS RAT) 84: 64000 b/s (X.31 flag stuffing) (only for UMTS RAT) 115: 56000 b/s (bit transparent) (only for UMTS RAT) 116: 64000 b/s (bit transparent) (only for UMTS RAT) 130: 28800 b/s (multimedia) (only for UMTS RAT) 131: 32000 b/s (multimedia) (only for UMTS RAT) 133: 56000 b/s (multimedia) (only for UMTS RAT)



Parameter	Type	Description
		<ul style="list-style-type: none"> 134: 64000 b/s (multimedia) (only for UMTS RAT)
<name>	Number	Bearer service name <ul style="list-style-type: none"> 0: data circuit asynchronous (UDI or 3.1 kHz modem) (default and factory-programmed value) 1: data circuit synchronous (UDI or 3.1 kHz modem)
<ce>	Number	Connection element <ul style="list-style-type: none"> 0: transparent 1: non-transparent (default and factory-programmed value) 2: both, transparent preferred (RAT GSM only) 3: both, non-transparent preferred (RAT GSM only)

12.2.4 Notes

- Several <speed> values are allowed in GSM or UMTS RAT only: see the parameter's description for correct settings.
- The modules do not support all the parameter combinations listed in 3GPP TS 22.002 [58].

LISA-U / SARA-U

- See [Table 5](#) (in the `+UDCONF=32` command description) for a more detailed list of the parameter combinations supported.

SARA-G

- The default and factory-programmed value of <speed> is 7.
- These values of <speed> are not supported: 12, 14, 15, 16, 75, 79, 80, 81, 83, 84, 115, 116, 130, 131, 133 and 134.
- See [Table 3](#) for a more detailed list of the parameter combinations supported.

LEON-G

- The default and factory-programmed value of <speed> is 7.
- These values of <speed> are not supported: 12, 14, 15, 16, 75, 79, 80, 81, 83, 84, 115, 116, 130, 131, 133 and 134.
- See [Table 3](#) for a more detailed list of the parameter combinations supported.

LEON-G / SARA-G

Connection type	Transfer capability type	AT+CBST	Rate (bit/s)	Type
Async transparent	Audio 3.1 kHz	4,0,0	2400	V22 bis
		5,0,0	2400	V26 ter
		6,0,0	4800	V32
	UDI Data	7,0,0	9600	V32
		68,0,0	2400	V110
		70,0,0	4800	V110
Async non transparent	Audio 3.1 kHz	71,0,0	9600	V110
		0,0,1	Autobauding	Autobauding
		6,0,1	4800	V32
	UDI Data	7,0,1	9600	V32
		70,0,1	4800	V110
		71,0,1	9600	V110
Async transparent preferred	Audio 3.1 kHz	0,0,2	Autobauding	Autobauding
		6,0,2	4800	V32
		7,0,2	9600	V32
	UDI Data	70,0,2	4800	V110
		71,0,2	9600	V110
		0,0,3	Autobauding	Autobauding
Async non transparent preferred	Audio 3.1 kHz	6,0,3	4800	V32
		7,0,3	9600	V32
	UDI Data	70,0,3	4800	V110

Connection type	Transfer capability type	AT+CBST	Rate (bit/s)	Type
		71,0,3	9600	V110

Table 3: AT+CBST parameter combinations

12.3 Connection type groups configuration +UDCONF=32

+UDCONF=32						
Modules	LISA-U200-01S LISA-U200-02S LISA-U200-52S LISA-U200-62S LISA-U200-82S LISA-U230 LISA-U260 LISA-U270 SARA-U					
Attributes	Syntax	PIN required	Settings saved	Can be aborted	Response time	Error reference
	partial	No	<i>NVM</i>	No	-	<i>+CME Error</i>

12.3.1 Description

Enables/disables the connection type groups.



The new setting is saved in NVM and will be effective at the next power on.

12.3.2 Syntax

Type	Syntax	Response	Example
Set	AT+UDCONF=32,<conn_type_groups_bitmap>	OK	AT+UDCONF=32,1 OK
Read	AT+UDCONF=32	+UDCONF: 32,<active_conn_type_groups_bitmap>,<configured_conn_type_groups_bitmap> OK	AT+UDCONF=32 +UDCONF: 32,1,1 OK

12.3.3 Defined values

Parameter	Type	Description
<conn_type_groups_bitmap>	Number	Bitmask representing the list of "connection type groups" supported after the reboot. Valid range is 0-127 (equivalent to bits 0000000-1111111). The factory-programmed bitmask is 127 (all the groups are supported). See the Table 4 for the meaning of each bit. See the note below for the meaning of each group.
<active_conn_type_groups_bitmap>	Number	The currently active connection type groups, in the format described for <conn_type_groups_bitmap>
<configured_conn_type_groups_bitmap>	Number	The list of the connection type groups that is supported after reboot, in the format described for <conn_type_groups_bitmap>

12.3.4 Notes

Bit	Connection type group
0	UDI multimedia
1	UDI data
2	RDI
3	Audio 3.1 kHz
4	All sync transparent
5	All async transparent
6	All async non transparent

Table 4: Connection type group bit description

The connection type groups 4, 5 and 6 partially include the groups 1, 2 and 3. Enabling a super-group forces all sub-groups to be enabled; enabling a sub-group is possible even if the super-group is disabled.

The meaning of each data connection super-group is defined as follows:

Group	Transfer capability group	AT+CBST	Rate (bit/s)	Type	2G	3G
Async transparent	Audio 3.1 kHz	4,0,0	2400	V22 bis	•	
		5,0,0	2400	V26 ter	•	
		6,0,0	4800	V32	•	
		7,0,0	9600	V32	•	
		16,0,0	28800	V34		•
	UDI Data	68,0,0	2400	V110	•	
		70,0,0	4800	V110	•	
		71,0,0	9600	V110	•	
		0,0,1	Autobauding	Autobauding	•	•
		4,0,1	2400	V22 bis	•	
Async non transparent	Audio 3.1 kHz	5,0,1	2400	V26 ter	•	
		6,0,1	4800	V32	•	•
		7,0,1	9600	V32	•	•
		12,0,1	9600	V34		•
		14,0,1	14400	V34		•
		15,0,1	19200	V34		•
		16,0,1	28800	V34		•
	UDI Data	68,0,1	2400	V110	•	
		70,0,1	4800	V110	•	•
		71,0,1	9600	V110	•	•
		75,0,1	14400	V110		•
		79,0,1	19200	V110		•
		80,0,1	28800	V110		•
		81,0,1	38400	V110		•
RDI Data	83,0,1	56000	V110		•	
UDI Data	84,0,1	64000	FTM		•	
Sync transparent	Audio 3.1 kHz	16,1,0	28800	V34		•
	UDI Data	83,1,0	56000	V110		•
	RDI Data	115,1,0	56000	bit transparent		•
	UDI Data	116,1,0	64000	bit transparent		•
	UDI Multimedia	130,1,0	64000	multimedia		•
		131,1,0	64000	multimedia		•
		133,1,0	64000	multimedia		•
		134,1,0	64000	multimedia		•

Table 5: Data connection groups: meaning, availability and relationship with AT+CBST parameters

If a call class is disabled then:

- The outgoing calls are rejected when the ATD command is invoked (NO CARRIER is printed)
- The incoming calls are rejected by the stack and the user will receive no notification (e.g. no RING)

12.4 Circuit switched data configuration+UCSD

+UCSD						
Modules	LEON-G					
Attributes	Syntax	PIN required	Settings saved	Can be aborted	Response time	Error reference
	full	No	<i>NVM</i>	No	-	<i>+CME Error</i>



12.4.1 Description

Sets or gets the value of the specified parameter in a specific GSM circuit switched data (CSD) profile, or reads the current values of all parameters of the given PSD profile, listing them in separated lines.



The parameter values set with this command are volatile, but the whole profile may be stored in NVM with the AT+UCSDA command.



-  In the set command, if only the first two parameters are issued, the module returns the current setting of the corresponding remaining parameter. Otherwise only the "OK" result code is returned.
-  In the set command, if only the first parameter is issued, the module returns all the parameters of the given PSD profile, and lists them in separated lines.

12.4.2 Syntax

Type	Syntax	Response	Example
Set	Set command	OK	AT+UCSD=2,1,0
	AT+UCSD=<profile_id>,<param_tag>,<param_val>	OK	OK
Get	CSD Get command	+UCSD: <profile_id>,<param_tag>,<param_val>	AT+UCSD=2,1
	AT+UCSD=<profile_id>,<param_tag>	OK	+UCSD: 2,1,0
	CSD Get All command	+UCSD: <profile_id>,0,<param_val0>	OK
	AT+UCSD=<profile_id>	AT+UCSD=0
		OK	+UCSD: 0,0,"8001234564"
			+UCSD: 0,1,0
			+UCSD: 0,2,"username"
		+UCSD: 0,4,"0.0.0.0"	
		+UCSD: 0,5,"0.0.0.0"	
		+UCSD: 0,6,0	
		OK	

12.4.3 Defined values

Parameter	Type	Description
<profile_id>	Number	CSD profile identifier, in range 0-6
<param_tag>	Number	<ul style="list-style-type: none"> • 0: Phone number - <param_val> is defined by a text string, such as "36912345678". The factory-programmed value is an empty string. • 1: Call type - <param_val> may be: <ul style="list-style-type: none"> o 0 (factory-programmed value): analog o 1: ISDN • 2: Username - <param_val> is the user name text string for the authentication phase. The factory-programmed value is an empty string. • 3: Password - <param_val> is the password text string for the authentication phase. Note: the AT+UCSD Get command with <param_tag> = 3 is not allowed • 4: DNS1 - <param_val> is the text string of the primary DNS address in dotted decimal notation form (i.e. four numbers in range 0-255 separated by periods, like "xxx.yyy.zzz.www"). The factory-programmed value is "0.0.0.0". • 5: DNS2 - <param_val> is the text string of the secondary DNS address in dotted decimal notation form (i.e. four numbers in range 0-255 separated by periods, like "xxx.yyy.zzz.www"). The factory-programmed value is "0.0.0.0". • 6: Timeout (RFU) - <param_val> represents the linger time: if there is no data transfer for the given time-out, the call is hang-up). Note: currently not implemented. Parameter 6 can be neither set nor retrieved. The factory-programmed value is 0.

12.5 Circuit switched data action +UCSDA

+UCSDA						
Modules	LEON-G					
Attributes	Syntax	PIN required	Settings saved	Can be aborted	Response time	Error reference
	full	No	No	No	Up to 3 min	+CME Error

12.5.1 Description

Performs the requested action for the specified CSD profile.

12.5.2 Syntax

Type	Syntax	Response	Example
Set	AT+UCSDA=<profile_id>,<action>	OK	AT+UCSDA=3,0 OK
URC		+UUCSDD: <profile_id>	

12.5.3 Defined values

Parameter	Type	Description
<profile_id>	Number	CSD profile identifier, in range 0-6
<action>	Number	<ul style="list-style-type: none"> 0: Reset: clears the specified profile, resetting all parameters to their factory-programmed values 1: Store: saves all parameters of the specified profile in NVM for future retrieval 2: Load: reads all parameters of the specified profile from NVM 3: Activate: performs end-to-end connection establishment for the specified CSD profile, using its pre-defined parameters (i.e. service provider number) 4: Deactivate: releases the GSM data call associated with the specified CSD profile

12.5.4 Notes

- Only one profile at a time can be associated with an active GSM call.
- in case of remote disconnection of a GSM call associated to a CSD profile, the URC is sent to the TE to inform the user, otherwise the user is in charge of connection release after usage.

12.6 Circuit switched network-assigned data +UCSND

+UCSND						
Modules	LEON-G					
Attributes	Syntax	PIN required	Settings saved	Can be aborted	Response time	Error reference
	full	No	No	No	-	+CME Error

12.6.1 Description

Returns the current (dynamic) network-assigned value of the specified parameter of the active GSM data call associated with the specified CSD profile.

12.6.2 Syntax

Type	Syntax	Response	Example
Set	AT+UCSND=<profile_id>,<param_tag>	+UCSND: <profile_id>,<param_tag>,<dynamic_param_val> OK	AT+UCSND=2,0 +UCSND: 2,0,"151.9.78.170" OK

12.6.3 Defined values

Parameter	Type	Description
<profile_id>	Number	CSD profile identifier, in range 0-6
<param_tag>	Number	<ul style="list-style-type: none"> 0: IP address: dynamic IP address assigned during context activation 1: DNS1: dynamic primary DNS address 2: DNS2: dynamic secondary DNS address
<dynamic_param_val>	String	Value of the specified <param_tag>

12.7 Service class selection and identification +FCLASS

+FCLASS						
Modules	LEON-G SARA-G					
	LISA-U SARA-U					
Attributes	Syntax	PIN required	Settings saved	Can be aborted	Response time	Error reference
	partial	No	No	No	-	+CME Error

12.7.1 Description

Puts the MT into an operation mode (voice, data or FAX).

12.7.2 Syntax

Type	Syntax	Response	Example
Set	AT+FCLASS=<class>	OK	AT+FCLASS=2.0 OK
Read	AT+FCLASS?	<n> OK	0 OK
Test	AT+FCLASS=?	(List of supported <class>s) OK	(0,8) OK

12.7.3 Defined values

Parameter	Type	Description
<class>	Number	Operation mode <ul style="list-style-type: none"> • 0: data (default value) • 2.0: reserved • 8: voice

12.7.4 Notes

LISA-U / SARA-U

- The selected mode is only set for the following CS call.

LISA-U100 / LISA-110 / LISA-U200-00S

- <class>=8 is not supported.

SARA-G340 / SARA-G350

- <class>=2.0 is dedicated to FAX (service class 2).

SARA-G300 / SARA-G310

- <class>=8 is not supported.

LEON-G

- <class>=2.0 is dedicated to FAX (service class 2).

12.8 Service reporting control +CR

+CR						
Modules	LEON-G SARA-G					
	LISA-U SARA-U					
Attributes	Syntax	PIN required	Settings saved	Can be aborted	Response time	Error reference
	full	No	Profile	No	< 10 s	+CME Error

12.8.1 Description

Controls whether the intermediate result code is returned or not. If enabled, the intermediate result code is transmitted when, during the connection negotiation, the MT has determined which speed and quality of



service will be used, before any error control or data compression reports are transmitted, and before the intermediate result code CONNECT is transmitted.

12.8.2 Syntax

Type	Syntax	Response	Example
Set	AT+CR=[<mode>]	OK	AT+CR=0 OK
Read	AT+CR?	+CR: <mode> OK	+CR: 0 OK
Test	AT+CR=?	+CR: (list of supported <mode>s) OK	+CR: (0-1) OK
IRC		+CR: <serv>	

12.8.3 Defined values

Parameter	Type	Description
<mode>	Number	<ul style="list-style-type: none"> 0 (default value and factory-programmed value): disables reporting 1: enables reporting
<serv>	String	Service name <ul style="list-style-type: none"> ASYNC: asynchronous transparent REL ASYNC: asynchronous non-transparent (reliable) REL SYNC: synchronous non-transparent (reliable) SYNC: synchronous transparent

12.8.4 Notes

- <serv>=REL ASYNC applies only for incoming or outgoing data calls.

12.9 Cellular result codes +CRC

+CRC						
Modules	LEON-G SARA-G LISA-U SARA-U					
Attributes	Syntax	PIN required	Settings saved	Can be aborted	Response time	Error reference
	partial	No	<i>Profile</i>	No	-	<i>+CME Error</i>

12.9.1 Description

Enables the detailed ring indication for the incoming calls. Instead of RING, the +CRING: <type> URC is displayed.

12.9.2 Syntax

Type	Syntax	Response	Example
Set	AT+CRC=[<mode>]	OK	AT+CRC=0 OK
Read	AT+CRC?	+CRC: <mode> OK	+CRC: <mode> OK
Test	AT+CRC=?	+CRC: (list of supported <mode>s) OK	+CRC: (0-1) OK
URC		+CRING: <type>	

12.9.3 Defined values

Parameter	Type	Description
<mode>	Number	<ul style="list-style-type: none"> 0 (default value and factory-programmed setting): extended format disabled 1: extended format enabled

Parameter	Type	Description
<type>	String	Ring indication description: <ul style="list-style-type: none"> • ASYNC: asynchronous transparent • REL ASYNC: asynchronous non-transparent (reliable) • SYNC: synchronous transparent • REL SYNC: synchronous non-transparent (reliable) • FAX: facsimile (TS62) • VOICE: normal voice (TS11) • ALT VOICE / FAX: alternating voice/FAX, voice first (TS61) • ALT FAX / VOICE: alternating voice/FAX, FAX first (TS61) • GPRS <PDP_type>,<PDP_addr>,<L2P>,<APN>: GPRS network request for the PDP context activation

12.9.4 Notes

LISA-U / SARA-U

- <type>="FAX", "ALT VOICE / FAX", "ALT FAX / VOICE", "GPRS" are not supported.

LISA-U200-62S

- <type>=GPRS is supported. <PDP_type>,<PDP_addr>,<L2P>,<APN> are described in [Chapter 17.1](#).

SARA-G

- The <mode> parameter is mandatory.

SARA-G300 / SARA-G310

- <type>="FAX", "ALT VOICE / FAX", "ALT FAX / VOICE", "GPRS" are not supported.

LEON-G

- The <mode> parameter is mandatory.
- <type>=GPRS is not supported.

12.10 Radio link protocol +CRLP

+CRLP						
Modules	LEON-G SARA-G					
	LISA-U SARA-U					
Attributes	Syntax	PIN required	Settings saved	Can be aborted	Response time	Error reference
	full	No	<i>Profile</i>	No	-	<i>+CME Error</i>

12.10.1 Description

Sets the radio link protocol (RLP) parameters used when non-transparent data-calls are originated.



The advised configuration for an optimal IOT performance is AT+CRLP=61,61,48,7.

12.10.2 Syntax

Type	Syntax	Response	Example
Set	AT+CRLP=[<iws>[,<mws>[,<T1>[,<N2>]]]]	OK	AT+CRLP=61,61,48,6 OK
Read	AT+CRLP?	+CRLP: <iws>,<mws>,<T1>,<N2> OK	+CRLP: 61,61,48,6 OK
Test	AT+CRLP=?	+CRLP: (lists of supported <iws>),(lists of supported <mws>),(lists of supported <T1>),(lists of supported <N2>) OK	+CRLP: (0-61),(0-61),(39-255),(1-255) OK

12.10.3 Defined values

Parameter	Type	Description
<iws>	Number	IWF (Interworking Function) to MT window size, range 0 - 61 (default and factory-programmed value: 61)
<mws>	Number	MT to IWF (Interworking Function) window size, range 0 - 61 (default and factory-programmed value: 61)
<T1>	Number	Acknowledgement timer T1, expressed in dozen of msec, range 39 - 255 (default and factory-programmed value: 48)
<N2>	Number	Retransmission attempts, range 1 - 255 (default and factory-programmed value: 7)

12.10.4 Notes

LISA-U / LEON-G100-06S / SARA-G300-00S / SARA-G310-00S / SARA-G340-00S / SARA-G350-00S / SARA-G350-00X

- The default and factory-programmed value of <N2> is 6.

12.11 Extended error report +CEER

+CEER						
Modules	LEON-G SARA-G					
	LISA-U SARA-U					
Attributes	Syntax	PIN required	Settings saved	Can be aborted	Response time	Error reference
	partial	No	No	No	-	+CME Error

12.11.1 Description

Causes the MT to return one or more lines of information text which offer an extended report of the reason for:

- the failure in the last unsuccessful call setup or in-call modification,
- the last call release,
- the last unsuccessful GPRS attach or unsuccessful PDP context activation,
- the last GPRS detach or PDP context deactivation.

The total number of characters, including line terminators, in the information text shall not exceed 2041 characters. The textual report is the failure cause from 3GPP TS 24.008 [12]

12.11.2 Syntax

Type	Syntax	Response	Example
Action	AT+CEER	+CEER: <type>[,<cause>,<error_description>] OK	+CEER: "CC setup error",277,"SIM status failure" OK
Test	AT+CEER=?	OK	

12.11.3 Defined values

Parameter	Type	Description
<type>	String	<ul style="list-style-type: none"> CC setup error: <cause> and <error_description> parameters are provided CC modification error: <cause> and <error_description> parameters are provided CC release: <cause> and <error_description> parameters are provided SM attach error: <cause> and <error_description> parameters are provided SM detach: <cause> and <error_description> parameters are provided SM activation error: <cause> and <error_description> parameters are provided SM deactivation: <cause> and <error_description> parameters are provided SSnetwork GSM cause: <SS_cause_errors> parameters are provided SSnetwork reject cause: <tag> and <SS_cause> parameters are provided No report available: no more parameters are provided
<cause>	Number	Code number of the received error (internal or network originated); more details in Appendix A.9



Parameter	Type	Description
<error_description>	String	Code description of the received error; more details in Appendix A.9

12.11.4 Notes

SARA-G

- If no mapping for <cause> is available, the <error_description> response is "Unknown".

LEON-G

- <type> parameter is not supported while <cause> and <error_description> parameters are mandatory in the response to the action command.
- If no mapping for <cause> is available, the <error_description> response is "Unknown".

12.12 Proprietary extended error report +UCEER

+UCEER						
Modules	LISA-U1 LISA-U200-00S					
Attributes	Syntax	PIN required	Settings saved	Can be aborted	Response time	Error reference
	partial	No	No	No	-	+CEER Error

12.12.1 Description

Causes the MT to return one or more lines of information text (<report>,<cause>) determined by the MT providing an extended report of the reason of:

- The failure in the last unsuccessful call setup or in-call modification
- The last call release
- The last unsuccessful GPRS attach or unsuccessful PDP context activation
- The last GPRS detach or PDP context deactivation

12.12.2 Syntax

Type	Syntax	Response	Example
Action	AT+UCEER	+UCEER: <report>,<cause> OK	+UCEER: 1,1 OK
Test	AT+UCEER=?	OK	

12.12.3 Defined values

Parameter	Type	Description
<report>	Number	Numeric error code
<cause>	Number	Indicates the error code as previously displayed with the response CME ERROR on DTE corresponding to the <report>

13. FAX class 2

13.1 Introduction

FAX commands are compliant with ITU_T recommendation V250 and V.25ter.

FAX service is carried out in five separate and consecutive phases:

- Phase A: Call set-up
- Phase B: Pre-message procedure for identifying and selecting the required facilities
- Phase C: Message transmission
- Phase D: Post-message procedure including end-of-message, confirmation and multi-document procedures
- Phase E: Call release

13.2 Adaptive answer +FAA

+FAA						
Modules	LEON-G SARA-G340 SARA-G350					
Attributes	Syntax	PIN required	Settings saved	Can be aborted	Response time	Error reference
	full	Yes	No	No	-	+CME Error

13.2.1 Description

Allows an adaptive answer of DCE depending on the parameter <value>.

13.2.2 Syntax

Type	Syntax	Response	Example
Set	AT+FAA=<value>	OK	
Read	AT+FAA?	<value>	
		OK	
Test	AT+FAA=?	(range of <value>s)	(0-1)
		OK	OK

13.2.3 Defined values

Parameter	Type	Description
<value>	Number	<ul style="list-style-type: none"> • 0: the DCE shall answer only as a Class 2 facsimile device • 1: the DCE can automatically determine whether to answer as a facsimile DCE (in case of FAX call or alternate speech/fax call is detected) or as a data modem. If a data modem is detected, the DCE shall operate as described in ITU-T Recommendation T.32 par. 8.3.2.4.

13.3 Address & polling capabilities +FAP

+FAP						
Modules	LEON-G SARA-G340 SARA-G350					
Attributes	Syntax	PIN required	Settings saved	Can be aborted	Response time	Error reference
	full	Yes	No	No	-	+CME Error

13.3.1 Description

Enables sending and receiving of SUB, SEP, and PWD frames.

13.3.2 Syntax

Type	Syntax	Response	Example
Set	AT+FAP=<sub>,<sep>,<pwd>	OK	
Read	AT+FAP?	<sub>,<sep>,<pwd>	

Type	Syntax	Response	Example
		OK	
Test	AT+FAP=?	(range of <sub>s), (range of <sep>s), (range of <pwd>s)	(0-1),(0-1),(0-1)
		OK	

13.3.3 Defined values

Parameter	Type	Description
<sub>	Number	Subaddressing; default value: 0
<sep>	Number	Selective polling; default value: 0
<pwd>	Number	Password; default value: 0

13.4 Buffer size +FBS

+FBS						
Modules	LEON-G SARA-G340 SARA-G350					
Attributes	Syntax	PIN required	Settings saved	Can be aborted	Response time	Error reference
	full	Yes	No	No	-	+CME Error

13.4.1 Description

Allows the DCE to report the size of its data buffers for FAX services.

13.4.2 Syntax

Type	Syntax	Response	Example
Read	AT+FBS?	<tbs>,<rbs>	
		OK	

13.4.3 Defined values

Parameter	Type	Description
<tbs>	Number	Transmit buffer size, i.e. 2048 bytes
<rbs>	Number	Receive buffer size, i.e. 2048 bytes

13.5 Data bit order +FBO

+FBO						
Modules	LEON-G SARA-G340 SARA-G350					
Attributes	Syntax	PIN required	Settings saved	Can be aborted	Response time	Error reference
	full	Yes	No	No	-	+CME Error

13.5.1 Description

Controls the mapping between PSTN facsimile data and the DTE-DCE link. There are two options:

- Direct order: the first bit of each octet transferred on the DTE-DCE link is the first bit transferred on the GSTN (General Switched Telephone Network) data carrier
- Reversed order: the last bit of each octet transferred on the DTE-DCE link is the first bit transferred on the GSTN data carrier

13.5.2 Syntax

Type	Syntax	Response	Example
Set	AT+FBO=<value>	OK	
Read	AT+FBO?	<value>	
		OK	
Test	AT+FBO=?	(range of <value>s)	(0-3)

Type	Syntax	Response	Example
Test	AT+FCC=?	OK (range of <vr>s),(range of s),(range of <wd>s),(range of <ln>s),(range of <df>s),(range of <ec>s),(range of <bf>s),(range of <st>s),(range of <jp>s) OK OK	(0-1),(0-3),(0),(0-2),(0),(0),(0),(0-7),(0)

13.7.3 Defined values

Parameter	Type	Description
<vr>	Number	Resolution in range 0-1
 	Number	Bit rate in range 0-3
<wd>	Number	Page width in pixels; only 0 value allowed
<ln>	Number	Page length in range 0-2
<df>	Number	Data compression format; only 0 value allowed
<ec>	Number	Error correction; only 0 value allowed
<bf>	Number	File transfer; only 0 value allowed
<st>	Number	Scan time/line; in range 0-7
<jp>	Number	JPEG for colour and B&W; only 0 value allowed

13.8 Copy quality checking +FCQ

+FCQ						
Modules	LEON-G.SARA-G340 SARA-G350					
Attributes	Syntax	PIN required	Settings saved	Can be aborted	Response time	Error reference
	full	Yes	No	No	-	+CME Error

13.8.1 Description

Allows the control of copy quality checking and correction by a facsimile DCE.

13.8.2 Syntax

Type	Syntax	Response	Example
Set	AT+FCQ=<rq>,<tq>	OK	
Read	AT+FCQ?	<rq>,<tq> OK	
Test	AT+FCQ=?	(range of <rq>s),(range of <tq>s) OK	(0),(0) OK

13.8.3 Defined values

Parameter	Type	Description
<rq>	Number	Controls copy quality checking and correction of data received from the remote station and delivered to DTE
<tq>	Number	Controls copy quality checking and correction of image data received from the DTE and sent to the remote station

13.9 Capability to receive data +FCR

+FCR						
Modules	LEON-G.SARA-G340 SARA-G350					
Attributes	Syntax	PIN required	Settings saved	Can be aborted	Response time	Error reference
	full	Yes	No	No	-	+CME Error

13.9.1 Description

Sets the capability to receive message data.

13.9.2 Syntax

Type	Syntax	Response	Example
Set	AT+FCR=<value>	OK	
Read	AT+FCR?	<value>	
Test	AT+FCR=?	OK (supported <value>)	(1) OK

13.9.3 Defined values

Parameter	Type	Description
<value>	Number	Only value 1 allowed; DCE can receive message data. Bit 10 in the DIS or DTC frame will be set

13.10 Current session results +FCS

+FCS						
Modules	LEON-G SARA-G340 SARA-G350					
Attributes	Syntax	PIN required	Settings saved	Can be aborted	Response time	Error reference
	full	Yes	No	No	-	+CME Error

13.10.1 Description

Allows displaying the current session results, either as a response to the read syntax or as an intermediate result code during the execution of +FDT.

13.10.2 Syntax

Type	Syntax	Response	Example
Read	AT+FCS?	<vr>, ,<wd>,<ln>,<df>,<ec>,<bf>,<st>,<jp> OK	
IRC		+FCS=<vr>, ,<wd>,<ln>,<df>,<ec>,<bf>,<st>,<jp>	
IRC		+FDCS=<vr>, ,<wd>,<ln>,<df>,<ec>,<bf>,<st>,<jp>	

13.10.3 Defined values

See +FCC.

13.11 DTE phase C response timeout +FCT

+FCT						
Modules	LEON-G SARA-G340 SARA-G350					
Attributes	Syntax	PIN required	Settings saved	Can be aborted	Response time	Error reference
	full	Yes	No	No	-	+CME Error

13.11.1 Description

Determines how long the DCE will wait for a command after having transmitted all available phase C data.

13.11.2 Syntax

Type	Syntax	Response	Example
Set	AT+FCT=<value>	OK	
Read	AT+FCT?	<value>	
Test	AT+FCT=?	OK (range of <value>s)	(1-FF) OK

13.11.3 Defined values

Parameter	Type	Description
<value>	Number	Range 0x0-0xFF, in 1 second units. Default value: 0x1E (30) s

13.12 Receive data +FDR

+FDR						
Modules	LEON-G SARA-G340 SARA-G350					
Attributes	Syntax	PIN required	Settings saved	Can be aborted	Response time	Error reference
	full	Yes	No	No	-	+CME Error

13.12.1 Description

Initiates data reception.

13.12.2 Syntax

Type	Syntax	Response	Example
Action	AT+FDR	OK	

13.13 Transmit Data +FDT

+FDT						
Modules	LEON-G SARA-G340 SARA-G350					
Attributes	Syntax	PIN required	Settings saved	Can be aborted	Response time	Error reference
	full	Yes	No	No	-	+CME Error

13.13.1 Description

Prefixes data transmission. It requests the DCE to transmit a phase C page. It is issued at the beginning of each page in phase B or D.

13.13.2 Syntax

Type	Syntax	Response	Example
Action	AT+FDT	OK	

13.14 Phase C received EOL alignment +FEA

+FEA						
Modules	LEON-G SARA-G340 SARA-G350					
Attributes	Syntax	PIN required	Settings saved	Can be aborted	Response time	Error reference
	full	Yes	No	No	-	+CME Error

13.14.1 Description

Controls optional octet-alignment of EOL markers in received T.4 data stream. It does not apply to T.6 data, or to any form of data.

13.14.2 Syntax

Type	Syntax	Response	Example
Set	AT+FEA=<value>	OK	
Read	AT+FEA?	<value>	
		OK	
Test	AT+FEA=?	(supported <value>s)	(0)
		OK	OK

13.14.3 Defined values

Parameter	Type	Description
<value>	Number	<ul style="list-style-type: none"> 0: determines that T.4 EOL patterns are bit aligned (as received) 1: determines that the last received bits of T.4 EOL patterns are octet aligned by the DCE, with necessary zero fill bits inserted (RFU)

13.15 Format conversion +FFC

+FFC						
Modules	LEON-G SARA-G340 SARA-G350					
Attributes	Syntax	PIN required	Settings saved	Can be aborted	Response time	Error reference
	full	Yes	No	No	-	+CME Error

13.15.1 Description

Determines the DCE response to mismatches between the phase C data delivered after the +FDT command and the data format parameters negotiated for the facsimile session. Currently no check or conversion is supported.

13.15.2 Syntax

Type	Syntax	Response	Example
Set	AT+FFC=<vrc>,<dfv>,<inc>,<wdc>	OK	
Read	AT+FFC?	<vrc>,<dfv>,<inc>,<wdc>	
Test	AT+FFC=?	OK (list of supported <vrc>s),(list of supported <dfv>s),(list of supported <inc>s),(list of supported <wdc>s) OK	(0),(0),(0),(0) OK

13.15.3 Defined values

Parameter	Type	Description
<vrc>	Number	vertical resolution format codes <ul style="list-style-type: none"> 0: ignored 1: enabled (RFU) 2: enabled for 1-D data (RFU) 3: enabled for 2-D data (RFU)
<dfc>	Number	data format codes <ul style="list-style-type: none"> 0: ignored 1: checking enabled (RFU) 2: conversion (RFU)
<inc>	Number	page length format codes <ul style="list-style-type: none"> 0: ignored 1: checking enabled (RFU) 2: conversion for 1-D data (RFU) 3: conversion enabled for 2-D data (RFU)
<wdc>	Number	page with format codes <ul style="list-style-type: none"> 0: ignored 1: checking enabled (RFU) 2: conversion enabled (RFU)

13.16 Report file transfer diagnostic frame +FFD

+FFD						
Modules	LEON-G SARA-G340 SARA-G350					
Attributes	Syntax	PIN required	Settings saved	Can be aborted	Response time	Error reference
	full	Yes	No	No	-	+CME Error

13.16.1 Description

This command has no parameters.

13.16.2 Syntax

Type	Syntax	Response	Example
Action	AT+FFD	OK	

13.17 Call termination status +FHS

+FHS						
Modules	LEON-G SARA-G340 SARA-G350					
Attributes	Syntax	PIN required	Settings saved	Can be aborted	Response time	Error reference
	full	Yes	No	No	-	+CME Error

13.17.1 Description

indicates the cause of a hang-up; the cause is set by the DCE at the conclusion of a FAX session and reset to 0 at the beginning of phase A.

13.17.2 Syntax

Type	Syntax	Response	Example
Read	AT+FHS?	<value>	
		OK	

13.17.3 Defined values

Parameter	Type	Description
<value>	Number	<ul style="list-style-type: none"> • 0x00: undefined • 0x02: fax call cleared by the remote modem or the DTE • 0x 11: Fax modem timed out in phase B • 0x20: Unspecified transmitting phase B error • 0x23: Invalid command received in transmitting phase B • 0x40: Unspecified transmitting phase C error • 0x43: Send fax data underflow • 0x70: Unspecified receiving phase B error • 0x50: Unspecified transmitting phase D error • 0xA0: Unspecified receiving phase D error

13.18 Procedure interrupt enable +FIE

+FIE						
Modules	LEON-G SARA-G340 SARA-G350					
Attributes	Syntax	PIN required	Settings saved	Can be aborted	Response time	Error reference
	full	Yes	No	No	-	+CME Error

13.18.1 Description

Controls the procedure of interrupt handling.

13.18.2 Syntax

Type	Syntax	Response	Example
Set	AT+FIE=<value>	OK	
Read	AT+FIE?	<value>	
		OK	
Test	AT+FIE=?	(range of <value>s)	(0-1)
		OK	OK
IRC		+FET:<pmc>	

13.18.3 Defined values

Parameter	Type	Description
<value>	Number	<ul style="list-style-type: none"> 0: procedure interrupt requests from the remote station are ignored and not reported to DTE 1: procedure interrupt requests from the remote station are reported to DTE (allowed only on alternate speech/fax calls) as intermediate result code +FET
<pmc>	Number	Post message command <ul style="list-style-type: none"> 0: MultiPage Signal - to indicate the end of a complete page of facsimile information and the return to phase C upon receipt of a confirmation 1: End Of Message - to indicate the end of a complete page of facsimile information and return to phase B 2: End Of Procedure - to indicate the end of a complete page of facsimile information and proceeding to phase E upon receipt of a confirmation 3: same as 0, with return to phase B if operator intervention is accomplished 4: same as 1, with return to phase B if operator intervention is accomplished 5: same as 2, with return to phase B if operator intervention is accomplished

13.19 Initialize facsimile parameters +FIP

+FIP						
Modules	LEON-G SARA-G340 SARA-G350					
Attributes	Syntax	PIN required	Settings saved	Can be aborted	Response time	Error reference
	full	Yes	No	No	-	+CME Error

13.19.1 Description

Causes the DCE to initialize all Service Class Facsimile Parameters to the factory-programmed settings. It does not change the +FCLASS setting. It should not be used when FAX connections are active.

13.19.2 Syntax

Type	Syntax	Response	Example
Set	AT+FIP=[<value>]	OK	
Read	AT+FIP?	0	
		OK	
Test	AT+FIP=?	(list of supported <value>s)	(0)
		OK	OK

13.19.3 Defined values

Parameter	Type	Description
<value>	Number	indicates the profile; only one profile is possible for <value>=0

Type	Syntax	Response	Example
Test	AT+FIT=?	(range of <time>s),(supported <action>)	(0-255),(0)
		OK	OK

13.21.3 Defined values

Parameter	Type	Description
<time>	Number	Timer duration in seconds, range 0-255
<action>	Number	Only value 0 possible, which means: when timer expire, the DCE shall clear the call.

13.22 Session termination +FKS, +FK

+FK						
Modules	LEON-G SARA-G340 SARA-G350					
Attributes	Syntax	PIN required	Settings saved	Can be aborted	Response time	Error reference
	full	Yes	No	No	-	+CME Error

13.22.1 Description

Causes the DCE to terminate the session in an orderly manner: if the DCE has an active, non-transmitting FAX call, it will send a DCN message and hang up.

13.22.2 Syntax

Type	Syntax	Response	Example
Set	AT+FK<S>	OK	

13.23 Local ID string +FLI

+FLI						
Modules	LEON-G SARA-G340 SARA-G350					
Attributes	Syntax	PIN required	Settings saved	Can be aborted	Response time	Error reference
	full	Yes	No	No	-	+CME Error

13.23.1 Description

Determines that DCE sends the ID frame if +FLI is not a zero-string.

13.23.2 Syntax

Type	Syntax	Response	Example
Set	AT+FLI=<local ID string>	OK	
Read	AT+FLI?	<local ID string>	
		OK	
Test	AT+FLI=?	(range of char values)	(20-7E)
		OK	OK

13.23.3 Defined values

Parameter	Type	Description
<local ID string>	String	20 digit string; valid codes for characters are in the range 0x20-0x7E

13.24 Set flow control +FLO

+FLO						
Modules	LEON-G SARA-G340 SARA-G350					
Attributes	Syntax	PIN required	Settings saved	Can be aborted	Response time	Error reference
	full	Yes	No	No	-	+CME Error

13.24.1 Description

Allows setting the flow control for communication via V.24 interface.

13.24.2 Syntax

Type	Syntax	Response	Example
Set	AT+FLO=<value>	OK	
Read	AT+FLO?	<value>	
		OK	
Test	AT+FLO=?	(range of <value>s)	(0-2)
		OK	OK

13.24.3 Defined values

Parameter	Type	Description
<value>	Number	indicates the kind of flow control <ul style="list-style-type: none"> • 0: DTE-DCE flow control is disabled • 1: DTE-DCE flow control is DC1/DC3 (SW flow control) • 2: DTE-DCE flow control is RTC/CTS (HW flow control)

13.25 Indicate document to poll +FLP

+FLP						
Modules	LEON-G SARA-G340 SARA-G350					
Attributes	Syntax	PIN required	Settings saved	Can be aborted	Response time	Error reference
	full	Yes	No	No	-	+CME Error

13.25.1 Description

Indicates that a document is available for retrieval. By default the DTE has no document to poll.

13.25.2 Syntax

Type	Syntax	Response	Example
Set	AT+FLP=<value>	OK	
Read	AT+FLP?	<value>	
		OK	
Test	AT+FLP=?	(range of <value>s)	(0)
		OK	OK

13.25.3 Defined values

Parameter	Type	Description
<value>	Number	only value 0 is allowed

13.26 Request manufacturer identification +FMI

+FMI						
Modules	LEON-G SARA-G340 SARA-G350					
Attributes	Syntax	PIN required	Settings saved	Can be aborted	Response time	Error reference
	full	No	No	No	-	+CME Error

13.26.1 Description

Text string identifying the manufacturer.

13.26.2 Syntax

Type	Syntax	Response	Example
Action	AT+FMI	<manufacturer> OK	u-blox OK
Test	AT+FMI=?	OK	

13.26.3 Defined values

Parameter	Type	Description
<manufacturer>	String	manufacturer name

13.27 Request model identification +FMM

+FMM						
Modules	LEON-G SARA-G340 SARA-G350					
Attributes	Syntax	PIN required	Settings saved	Can be aborted	Response time	Error reference
	full	No	No	No	-	+CME Error

13.27.1 Description

Text string identifying the model identification.

13.27.2 Syntax

Type	Syntax	Response	Example
Action	AT+FMM	<model> OK	SARA-G350 OK
Test	AT+FMM=?	OK	

13.27.3 Defined values

Parameter	Type	Description
<model>	String	Name of model

13.28 Request revision identification +FMR

+FMR						
Modules	LEON-G SARA-G340 SARA-G350					
Attributes	Syntax	PIN required	Settings saved	Can be aborted	Response time	Error reference
	full	No	No	No	-	+CME Error

13.28.1 Description

Gives the firmware version of the module.

13.28.2 Syntax

Type	Syntax	Response	Example
Action	AT+FMR	<version>	07.11.00

Type	Syntax	Response	Example
		OK	OK
Test	AT+FMR=?	OK	

13.28.3 Defined values

Parameter	Type	Description
<version>	String	Firmware version

13.29 Minimum phase C speed +FMS

+FMS						
Modules	LEON-G SARA-G340 SARA-G350					
Attributes	Syntax	PIN required	Settings saved	Can be aborted	Response time	Error reference
	full	Yes	No	No	-	+CME Error

13.29.1 Description

Limits the lowest negotiable speed for a fax session.

13.29.2 Syntax

Type	Syntax	Response	Example
Set	AT+FMS=<value>	OK	
Read	AT+FMS?	<value>	
		OK	
Test	AT+FMS=?	(range of <value>s)	(0-3)
		OK	OK

13.29.3 Defined values

Parameter	Type	Description
<value>	Number	<ul style="list-style-type: none"> 0: 2400 b/s (default) 1: 4800 b/s 2: 7200 b/s 3: 9600 b/s

13.30 Negotiation reporting +FNR

+FNR						
Modules	LEON-G SARA-G340 SARA-G350					
Attributes	Syntax	PIN required	Settings saved	Can be aborted	Response time	Error reference
	full	Yes	No	No	-	+CME Error

13.30.1 Description

Controls the reporting of messages generated during T.30 phase B negotiations.

13.30.2 Syntax

Type	Syntax	Response	Example
Set	AT+FNR=[<rpr>[,<tpr>[,<idr>[,<nrs>]]]]	OK	
Read	AT+FNR?	<rpr>,<tpr>,<idr>,<nrs>	
		OK	
Test	AT+FNR=?	(range of <rpr>s), (range of <tpr>), (range of <idr>s), (range of <nrs>s)	(0-1),(0-1),(0-1),(0-1) OK
		OK	

13.30.3 Defined values

Parameter	Type	Description
<rpr>	Number	Receiver parameters reporting: 0-1 (no-yes)
<tp>	Number	Transmitter parameters reporting: 0-1 (no-yes)
<idr>	String	ID strings reporting: 0-1 (no-yes)
<nsr>	String	Non-standard frame FIF octet string +FNS

13.31 Non-standard frame FIF octet string +FNS

+FNS						
Modules	LEON-G SARA-G340 SARA-G350					
Attributes	Syntax	PIN required	Settings saved	Can be aborted	Response time	Error reference
	full	Yes	No	No	-	+CME Error

13.31.1 Description

Allows configuring the corresponding non-standard facilities frame. The command is not currently used.

13.31.2 Syntax

Type	Syntax	Response	Example
Set	AT+FNS=<string>	OK	
Read	AT+FNS?	<string>	
		OK	
Test	AT+FNS=?	(range of character codes)	(20-7E)
		OK	OK

13.31.3 Defined values

Parameter	Type	Description
<string>	String	Characters in range 0x20-0x7E

13.32 NSF message data indication +FND

+FND						
Modules	LEON-G SARA-G340 SARA-G350					
Attributes	Syntax	PIN required	Settings saved	Can be aborted	Response time	Error reference
	full	Yes	No	No	-	+CME Error

13.32.1 Description

Controls indication of non-standard facilities frames. The command is not currently used.

13.32.2 Syntax

Type	Syntax	Response	Example
Set	AT+FND=<value>	OK	
Read	AT+FND?	<value>	
		OK	
Test	AT+FND=?	(range of <value>s)	(0-1)
		OK	OK

13.32.3 Defined values

Parameter	Type	Description
<value>	Number	range 0-1 (enabled/disabled).

13.33 Selective polling address +FPA

+FPA						
Modules	LEON-G SARA-G340 SARA-G350					
Attributes	Syntax	PIN required	Settings saved	Can be aborted	Response time	Error reference
	full	Yes	No	No	-	+CME Error

13.33.1 Description

Sets the selective polling address. The DCE should send the numeric string contained in the +FPA at the times specified in T.30, if the corresponding parameter is not a zero string. The command is not currently used.

13.33.2 Syntax

Type	Syntax	Response	Example
Set	AT+FPA=<selective polling address string>	OK	AT+FPA="1234" OK
Read	AT+FPA?	<selective polling address string> OK	"1234" OK
Test	AT+FPA=?	(range of character codes) OK	(20-7E) OK

13.33.3 Defined values

Parameter	Type	Description
<selective polling address string>	String	20 digit string; values are in range 0x20-0x7E

13.34 Local polling ID string +FPI

+FPI						
Modules	LEON-G SARA-G340 SARA-G350					
Attributes	Syntax	PIN required	Settings saved	Can be aborted	Response time	Error reference
	full	Yes	No	No	-	+CME Error

13.34.1 Description

Allows the DCE to send the ID frame if +FPI is not a null string. The command is not currently used.

13.34.2 Syntax

Type	Syntax	Response	Example
Set	AT+FPI=<local polling ID string>	OK	
Read	AT+FPI?	<local polling ID string> OK	"1234" OK
Test	AT+FPI=?	(range of character codes) OK	(20-7E) OK

13.34.3 Defined values

Parameter	Type	Description
<local polling ID string>	String	only null string "" is allowed

13.35 Packet protocol control +FPP

+FPP						
Modules	LEON-G SARA-G340 SARA-G350					
Attributes	Syntax	PIN required	Settings saved	Can be aborted	Response time	Error reference
	full	Yes	No	No	-	+CME Error

13.35.1 Description

Allows controlling the packet protocol. The packet protocol is not currently supported.

13.35.2 Syntax

Type	Syntax	Response	Example
Set	AT+FPP=[<value>]	OK	
Read	AT+FPP?	<value>	
		OK	
Test	AT+FPP=?	(supported <value>)	(0)
		OK	OK

13.35.3 Defined values

Parameter	Type	Description
<value>	Number	only value 0 allowed

13.36 Page status +FPS

+FPS						
Modules	LEON-G SARA-G340 SARA-G350					
Attributes	Syntax	PIN required	Settings saved	Can be aborted	Response time	Error reference
	full	Yes	No	No	-	+CME Error

13.36.1 Description

Sets the post page response, in particular end-of-page status, to be sent to the remote part. During fax transmission, post page response of the remote part is indicated to the DTE with an intermediate result code +FPS.

13.36.2 Syntax

Type	Syntax	Response	Example
Set	AT+FPS=[<value>]	OK	
Read	AT+FPS?	<value>	
		OK	
Test	AT+FPS=?	(range of <value>)	(1-5)
		OK	OK

13.36.3 Defined values

Parameter	Type	Description
<value>	Number	<ul style="list-style-type: none"> • 1: MCF, page good (default value) • 2: RTN, page bad; retrain requested • 3: RTP, page good; retrain requested • 4: PIN, page bad; interrupt requested • 5: PIP, page good; interrupt requested

13.37 Password parameter +FPW

+FPW						
Modules	LEON-G SARA-G340 SARA-G350					
Attributes	Syntax	PIN required	Settings saved	Can be aborted	Response time	Error reference
	full	Yes	No	No	-	+CME Error

13.37.1 Description

Sets the password. The DCE sends the numeric string contained in +FPW at the times specified in T.30, if the corresponding parameter is not a null string.

13.37.2 Syntax

Type	Syntax	Response	Example
Set	AT+FPW=<password string>	OK	AT+FPW="1234" OK
Read	AT+FPW?	"<password string>" OK	
Test	AT+FPW=?	(range of <value>) OK	"1234" OK

13.37.3 Defined values

Parameter	Type	Description
<password string>	String	Valid characters: 0-9, *, #, space

13.38 Receive quality thresholds +FRQ

+FRQ						
Modules	LEON-G SARA-G340 SARA-G350					
Attributes	Syntax	PIN required	Settings saved	Can be aborted	Response time	Error reference
	full	Yes	No	No	-	+CME Error

13.38.1 Description

Allows making the "Copy Quality OK" decision using the command parameters. The command is not currently used.

13.38.2 Syntax

Type	Syntax	Response	Example
Set	AT+FRQ=<pgl>,<cbl>	OK	
Read	AT+FRQ?	<pgl>,<cbl> OK	
Test	AT+FRQ=?	(supported <pgl>),(supported <cbl>) OK	(0),(0) OK

13.38.3 Defined values

Parameter	Type	Description
<pgl>	Number	Percentage of good lines: only value 0 accepted
<cbl>	Number	Consecutive bad lines: only value 0 accepted

13.39 Error correction mode retry count +FRY

+FRY						
Modules	LEON-G SARA-G340 SARA-G350					
Attributes	Syntax	PIN required	Settings saved	Can be aborted	Response time	Error reference
	full	Yes	No	No	-	+CME Error

13.39.1 Description

Controls the retry counter in Error Correcting Mode. The command is not currently used.

13.39.2 Syntax

Type	Syntax	Response	Example
Set	AT+FRY=[<value>]	OK	
Read	AT+FRY?	<count>	
		OK	
Test	AT+FRY=?	(range of <count>)	(0-FF)
		OK	OK

13.39.3 Defined values

Parameter	Type	Description
<value>	Number	In range 0-0xFF (0 if blank)

13.40 SubAddress parameter +FSA

+FSA						
Modules	LEON-G SARA-G340 SARA-G350					
Attributes	Syntax	PIN required	Settings saved	Can be aborted	Response time	Error reference
	full	Yes	No	No	-	+CME Error

13.40.1 Description

Sets the subaddress. The DCE sends the numeric string configured via AT+FSA at the times specified in T.30, if the corresponding parameter is not a null string.

13.40.2 Syntax

Type	Syntax	Response	Example
Set	AT+FSA=<destination SubAddress string>	OK	AT+FSA="1234"
		OK	
Read	AT+FSA?	"<destination SubAddress string>"	"1234"
		OK	OK
Test	AT+FSA=?	(range of character codes)	(20-7E)
		OK	OK

13.40.3 Defined values

Parameter	Type	Description
<destination SubAddress string>	String	20 digit string; allowed values: 0-9, *, #, space



13.41 Request to poll +FSP

+FSP						
Modules	LEON-G SARA-G340 SARA-G350					
Attributes	Syntax	PIN required	Settings saved	Can be aborted	Response time	Error reference
	full	Yes	No	No	-	+CME Error

13.41.1 Description

This command indicates whether or not the DTE wants to poll. The command is not currently used.

13.41.2 Syntax

Type	Syntax	Response	Example
Set	AT+FSP=[<value>]	OK	
Read	AT+FSP?	<value>	
		OK	
Test	AT+FSP=?	(supported <value>) OK	(0) OK

13.42 Fax intermediate result codes

13.42.1 Description

According to Recommendation T.32, Tab. 6, the following intermediate result codes are provided to the DTE during fax calls.

IRC	Meaning
+FCO	Indicates connection with a fax terminal
+FVO	Indicates transition to voice
+FHS	Call terminated with status
+FCS	Report the DCS frame information
+FDCS	Report the DCS frame information for speech/fax alternate calls
+FIS	Report the DIS frame information
+FTI	Report the remote (transmitting) ID, from TSI (Transmitting Subscriber Identification) frame
+FTSI	Report the remote (transmitting) ID, from TSI (Transmitting Subscriber Identification) frame for speech/fax alternate calls
+FCI	Report the remote (called) ID, from CSI (Called Subscriber Identification)
+FCSI	Report the remote (called) ID, from CSI (Called Subscriber Identification for speech/fax alternate calls)
+FET	Report post page message
+FPS	Report received page status
+FPTS	Report received page status for speech/fax alternate calls
+FHT	Report transmitted HDLC frames
+FHR	Debug report received HDLC frames

14. V24 control and V25ter

14.1 Introduction

These commands, unless specifically stated, do not implement set syntax using "=", read ("?"), or test ("=?"). If such commands are used, the error message "+CME ERROR: unknown" is displayed.



LEON-G / SARA-G

If the set, read or test syntax is used the error message "+CME ERROR: operation not supported" is displayed.

14.2 Circuit 109 behavior &C

&C						
Modules	LEON-G SARA-G					
	LISA-U SARA-U					
Attributes	Syntax	PIN required	Settings saved	Can be aborted	Response time	Error reference
	full	No	<i>Profile</i>	No	-	<i>+CME Error</i>

14.2.1 Description

Controls the behavior of RS232 circuit 109 - Data Carrier Detect (DCD) - relates to the detection of received line signal from the remote end.

14.2.2 Syntax

Type	Syntax	Response	Example
Action	AT&C[<value>]	OK	

14.2.3 Defined values

Parameter	Type	Description
<value>	Number	Indicates the behavior of circuit 109 <ul style="list-style-type: none"> • 0: DCE always presents ON condition on circuit 109 • 1 (default value and factory-programmed value): circuit 109 changes in accordance with the Carrier detect status; ON if the Carrier is detected, OFF otherwise

14.2.4 Notes

- Refer to the corresponding module System Integration Manual for the DCD behavior during the initialization phase of the module.

14.3 Circuit 108/2 behavior &D

&D						
Modules	LEON-G SARA-G					
	LISA-U SARA-U					
Attributes	Syntax	PIN required	Settings saved	Can be aborted	Response time	Error reference
	full	No	<i>Profile</i>	No	-	<i>+CME Error</i>

14.3.1 Description

Controls the behavior of RS232 circuit 108/2 - Data Terminal Ready (DTR) - relates to changes from ON to OFF condition during on-line data state.

14.3.2 Syntax

Type	Syntax	Response	Example
Action	AT&D[<value>]	OK	

14.3.3 Defined values

Parameter	Type	Description
<value>	Number	<ul style="list-style-type: none"> 0: the DCE ignores circuit 108/2 1 (default value and factory-programmed value): upon an ON-to-OFF transition of circuit 108/2, the DCE enters online command state and issues an OK result code 2: upon an ON-to-OFF transition of circuit 108/2, the DCE performs an orderly cleardown of the call. Automatic answer is disabled while circuit 108/2 remains OFF

14.3.4 ~+++ behavior in PSD &D

- A special meaning of the &D value is provided for the ~+++ sequence during a PSD data transfer with PPP L2 protocol (this is outside the V25-ter specification scope). The ~+++ causes context deactivation during a PSD data transfer session for the AT&D0 and AT&D2 value (the +++ return to on-line command mode is provided for each &D value during a CSD data call)
- A different implementation for the ~+++ is done with the &D1 value: PSD data transfer is escaped and system returns in the on-line command state. ATO command is used to resume the PSD data transfer session
- During the on-line command mode different AT commands can be sent but data calls in PSD on-line command mode cannot be granted (activate the AT+CRC=1 mode to identify the kind of call and reject data incoming calls if PSD is in the on-line command mode)



For more details refer to ITU-T Recommendation V250 [20], ITU-T V.25ter Recommendation [21] and ITU-T V.32 Recommendation [22].



Refer to the corresponding module System Integration Manual for the DTR behavior during the initialization phase of the module.

14.3.5 Circuit 108/2, +++ behavior for the different &D: summarizing tables

CSD data mode		
Event	DTE sends escape sequence (e.g. +++)	DTR On to Off transition
&D0	DCE enters command mode	No action
&D1	DCE enters command mode	Switch to command mode
&D2	DCE enters command mode	Cleardown call

Table 6: CSDData Mode

PSD data mode (PPP L2 protocol case)		
Event	DTE sends ~+++	DTR On to Off transition
&D0	Context deactivation	No action
&D1	DCE enters command mode	DCE enters command mode
&D2	Context deactivation	Context deactivation

Table 7: PSD Data Mode



The ON/OFF DTR transition in direct link forces the DCE into command mode. In case of AT&D0 the DTR transition is ignored, also in direct link.



The escape sequence for the PSD data mode with a L2 protocol different from the PPP is not ~+++, and it could be not supported. Refer to the [Table 8](#) for more information.

14.4 DSR override &S

&S						
Modules	LEON-G SARA-G					
	LISA-U SARA-U					
Attributes	Syntax	PIN required	Settings saved	Can be aborted	Response time	Error reference
	full	No	<i>Profile</i>	No	-	<i>+CME Error</i>

14.4.1 Description

Selects how the module will control RS232 circuit 107 - Data Set Ready (DSR).

14.4.2 Syntax

Type	Syntax	Response	Example
Action	AT&S[<value>]	OK	

14.4.3 Defined values

Parameter	Type	Description
<value>	Number	<ul style="list-style-type: none"> 0: sets the DSR line to ON 1 (default value and factory-programmed value): sets the DSR line to ON in data mode and to OFF in command mode

14.4.4 Notes

- Refer to the corresponding module System Integration Manual for the DSR behavior during the initialization phase of the module.

14.5 Flow control &K

&K						
Modules	LEON-G SARA-G					
	LISA-U SARA-U					
Attributes	Syntax	PIN required	Settings saved	Can be aborted	Response time	Error reference
	full	No	<i>Profile</i>	No	-	<i>+CME Error</i>

14.5.1 Description

Controls the flow control mechanism. The following settings are allowed:

- no flow control
- HW flow control also referred with RTS / CTS flow control
- SW flow control also referred with XON / XOFF flow control

14.5.2 Syntax

Type	Syntax	Response	Example
Action	AT&K[<value>]	OK	

14.5.3 Defined values

Parameter	Type	Description
<value>	Number	<ul style="list-style-type: none"> 0: disable DTE flow control 3 (default value and factory-programmed value): enable RTS/CTS DTE flow control 4: enable XON/XOFF DTE flow control 5: enable XON/XOFF DTE flow control 6: enable XON/XOFF DTE flow control

14.5.4 Notes

- The command handling is the same for <value> parameter 4, 5 or 6.



- Set the AT&K command to 0 (flow control disabled) when the RTS and CTS lines are not physically connected.
- The software flow control (XON/XOFF) setting is not allowed on the USB interfaces, on the SPI interface and on a multiplexer channel. Refer to [Appendix B.5](#) for all the behavior differences in respect to the supported interfaces.
- The SW flow control (XON/XOFF) activation is only allowed in case of the text transmission: the binary data cannot be transmitted because it may contain the special flow control characters (XON/XOFF).
- When the software flow control (XON/XOFF) is used, the DC1 (XON, 0x11) and DC3 (XOFF, 0x13) characters are reserved and therefore filtered (e.g. in SMS text mode these two characters can not be input).

Since the DTE-DCE communication relies on the correct reception of DC1/DC3 characters, the UART power saving should be disabled on the module when the SW flow control is used. If the UART power saving is active, the DC1/DC3 characters could be used to wake up the module's UART, and therefore lost. In case a DC3 character (XOFF) is correctly received by module's UART and some data is waiting to be transmitted, the module is forced to stay awake until a subsequent DC1 character (XON) is received.
- On the UART interface and if +UPSV=2, only &K0 (no flow control) is allowed.

14.5.5 SW flow control enhancement for PSD data transfer with PPP L2 protocol

 The software flow control enhancement is only supported on UART interface.

 LEON-G SARA-G LISA-U1 LISA-U2x0-x1S
The SW flow control enhancement is not supported.

The standard implementation of UART XON/XOFF flow control is limited to DTE-DCE communications where the ASCII non-printable control characters are not transferred. This is an important limitation, since it is not possible to use it in case of the generic binary data transfer. An extension to a PPP L2 protocol data transfer has been done by exploiting the PPP octet stuffing procedure.

PPP Octet-stuffed framing and transparency

The PPP protocol implements an escape mechanism specified to allow control data such as XON/XOFF to be transparently transmitted over the link, and to remove spurious control data which may be injected into the link by intervening hardware and software.

The control escape octet is defined as binary 01111101 (hexadecimal 0x7d), most significant bit first. As a minimum, sending implementations must escape the flag sequence and control escape octets.

After Frame Check Sequence (FCS) computation, the transmitter examines the entire frame between the two flag sequences. Each flag sequence, control escape octet, and any octet which is flagged in the sending Async-Control - Character-Map (ACCM), is replaced by a two octet sequence consisting of the control escape octet followed by the original octet exclusive-or'd with hexadecimal 0x20.

The receiving implementations must correctly process all the control escape sequences. On the reception, prior to FCS computation, each octet with value less than hexadecimal 0x20 is checked. If it is flagged in the receiving ACCM, it is simply removed (it may have been inserted by intervening data communications equipment). Each control escape octet is also removed, and the following octet is exclusive-or'd with hexadecimal 0x20, unless it is the flag sequence (which aborts a frame).

ACCM negotiation for XON/XOFF chars during PPP LCP negotiation

The ACCM is negotiated in a LCP (Link Control Protocol, part of PPP protocol) configuration request. In particular the LCP Option 02 is used.

This option is described in the RFC 1662 and has the following format.

| 02 | 06 | Async Control Character Map |



This configuration option provides a method to negotiate the use of control character transparency on asynchronous links.

The module by default would start in any case requesting an ACCM sets to 0x00000000, which is incompatible with XON/XOFF flow control.

To overcome this situation, the ACCM negotiation handler should combine the value received in a Configure-Nak via a logical bitwise OR operation with the last configure-request value it sent. This result should then be sent in the next Configure-Request message. If a configure-request is received whose bit mask includes cleared bits for characters that the local implementation knows to be problematic (perhaps by way of an administrative option or some kind of hardware information), then it should send a Configure-Nak with the prior value modified to have these bits set.

Application to XON/XOFF flow control implementation in the module

The flow control characters DC1 and DC3 appears at arbitrary locations in the data stream received by the module. The module with software flow control active during a PPP session, discards these characters after modifying the flow control state (stopping or starting its own transmit process) and does not include them in any part of the received data or CRC calculation; in the transmitted data the module escapes the XON/XOFF characters if they appear in the transmitted PPP frame. They are transmitted on the link as follows:

0x11 is encoded as 0x7d, 0x31. (XON)

0x13 is encoded as 0x7d, 0x33. (XOFF)

PPP ACCM negotiation in the module firmware is done in the following way:

- If XON/XOFF flow control is active on the UART when the PPP is invoked, the requested ACCM is 0x000A0000
- If XON/XOFF flow control is not active on the UART when the PPP is invoked, the requested ACCM is 0x00000000

As soon as the LCP configuration phase is completed, the IPCP protocol (the network control protocol for establishing and configuring Internet Protocol over a Point-to-Point Protocol link) can start; from this point forward the negotiated ACCM are applied.

If SW flow control is enabled on the module, but the DTE requests a wrong ACCM setting (ACCM differs than 0x0A0000) the SW flow control is anyway effective during the data mode, that is the 0x11 and 0x13 is detected during data mode even if the ACCM is not properly set by the DTE during LCP configuration.

14.6 DTE-DCE character framing +ICF

+ICF						
Modules	LEON-G SARA-G					
	LISA-U SARA-U					
Attributes	Syntax	PIN required	Settings saved	Can be aborted	Response time	Error reference
	partial	No	<i>Profile</i>	No	-	<i>+CME Error</i>

14.6.1 Description

Sets the local serial port start-stop (asynchronous) character framing which is used in information interchange between DCE and DTE. Value 0 corresponds to the auto-detect case (if autobauding is supported).



The following restrictions must be reminded:

- If a data frame format refers to a frame without parity (ex. Format 3), the command is accepted, but the parity value is ignored; it is returned by the AT+ICF? command (and displayed by AT&V) but it has no meaning
- The settings of the command are ignored when the AT command interface runs on the USB port or on the SPI interface

14.6.2 Syntax

Type	Syntax	Response	Example
Set	AT+ICF=[<format>[,<parity>]]	OK	AT+ICF=3,1 OK
Read	AT+ICF?	+ICF: <format>,<parity> OK	+ICF: 3,1 OK
Test	AT+ICF=?	+ICF: (list of supported <format>s),(list of supported <parity>s) OK	+ICF: (0-3,5),(0-1) OK

14.6.3 Defined values

Parameter	Type	Description
<format>	Number	<ul style="list-style-type: none"> 0: auto detect 1: 8 data 2 stop 2: 8 data 1 parity 1 stop 3: 8 data 1 stop 5: 7 bit, 1 parity, 1 stop
<parity>	Number	<ul style="list-style-type: none"> 0: odd 1: even

14.6.4 Notes

LISA-U2 / SARA-U

Automatic frame recognition

- If the parameters are omitted they are set to <format> = 3 and <parity> = 1.
- The factory-programmed values are <format> = 3 and <parity> = 1.
- If automatic baud rate detection (+IPR is set to 0) is enabled in the profile, the +ICF setting is not applied at start-up, and the read command returns the current detected frame format only after detection.
 - o Automatic frame recognition is present together with automatic baud rate recognition
 - o Since automatic frame recognition is implemented as "one shot", the AT+ICF=0 answers OK but does not switch the system to the automatic frame recognition and it does not take any actions. The read command always returns the current value of the frame format and the value of +ICF in the active profile is not changed
 - o If automatic frame recognition is enabled, the read command returns the current (detected) frame setting even if the current active profile provides +ICF=0. To change the frame format at the next module power on issue the set command with the new setting and save it in the profile
 - o The detectable frame configurations are: 7E1, 7O1, 8N1, 8E1, 8O1
 - o The stop bit number cannot be automatically recognized i.e. if the system is switched from the 8N2 to the autodetect feature and a 1 stop bit frame is provided at the serial port, the system can behave unpredictably

LISA-U200-00S

- Automatic frame recognition is not supported (<format> cannot be set to 0).

LEON-G / SARA-G

Automatic frame recognition

- If the parameters are omitted they are set to <format> = 0 and <parity> = 0.
- The factory-programmed values are <format> = 0 and <parity> = 0.
- Frame recognition can only be present in conjunction with autobauding recognition, i.e. the AT+ICF=0 command is effective only if AT+IPR is set to 0. In this case the AT+ICF? returns a 0 value.
 - o Outside the autobauding conditions the AT+ICF=0 answers OK but does not switch the system to automatic frame recognition and it does not take any actions. In this scenario the AT+ICF?

command returns the current value of the frame format. The AT+IPR=0 command instead forces the AT+ICF to 0

- o Under autobauding conditions, the AT+ICF command provided with a value different than 0 answers ERROR since it is not possible to specify a frame type in these autodetect conditions
- o The stop bit number cannot be automatically recognized i.e. if the system is switched from the 8N2 to the autodetect feature and an 1 stop bit frame is provided at the serial port, the system can behave unpredictably

14.7 DTE-DCE local flow control +IFC

+IFC						
Modules	LEON-G SARA-G					
	LISA-U SARA-U					
Attributes	Syntax	PIN required	Settings saved	Can be aborted	Response time	Error reference
	full	No	<i>Profile</i>	No	-	<i>+CME Error</i>

14.7.1 Description

Controls the operation of the local flow control between DTE and DCE used when the data are sent or received.

The SW flow control (XON/XOFF) activation is only allowed in case of the text transmission: the binary data cannot be transmitted because it may contain the special flow control characters (XON/XOFF). For SW flow control enhancement, allowing its usage during a PSD call with PPP L2 protocol, refer to the dedicated section ([Chapter 14.5.5](#)) in the AT&K command description.

When the software flow control (XON/XOFF) is used, the DC1 (XON, 0x11) and DC3 (XOFF, 0x13) characters are reserved and therefore filtered (e.g. in SMS text mode these two characters can not be input).

Since the DTE-DCE communication relies on the correct reception of DC1/DC3 characters, the UART power saving should be disabled on the module when SW flow control is used. If the UART power saving is active, the DC1/DC3 characters could be used to wake up the module's UART, and therefore lost. In case a DC3 character (XOFF) is correctly received by module's UART and some data is waiting to be transmitted, the module is forced to stay awake until a subsequent DC1 character (XON) is received.

 The software flow control (XON/XOFF) setting is not allowed on the USB interfaces, on the SPI interface and on a multiplexer channel. Refer to [Appendix B.5](#) for all the behavior differences in respect to the supported interfaces.

 On UART interface, if +UPSV is set to 2, only +IFC=0,0 (no flow control) is allowed.

14.7.2 Syntax

Type	Syntax	Response	Example
Set	AT+IFC=[<DCE_by_DTE>,<DTE_by_DCE>]	OK	AT+IFC=2,2 OK
Read	AT+IFC?	+IFC: <DCE_by_DTE>,<DTE_by_DCE> OK	+IFC: 2,2 OK
Test	AT+IFC=?	+IFC: (list of supported <DCE_by_DTE>), (list of supported <DTE_by_DCE>s) OK	+IFC: (0-2),(0-2) OK

14.7.3 Defined values

Parameter	Type	Description
<DCE_by_DTE>	Number	<ul style="list-style-type: none"> • 0: none • 1: DC1/DC3 on circuit 103 (XON/XOFF) • 2 (default and the factory-programmed value): circuit 105 (RTS)

Parameter	Type	Description
<DTE_by_DCE>	Number	<ul style="list-style-type: none"> 0: none 1: DC1/DC3 on circuit 104 (XON/XOFF) 2 (default and the factory-programmed value): circuit 106 (CTS)

14.7.4 Notes

- <DCE_by_DTE> and <DTE_by_DCE> must be provided with the same value in pairs (only (0,0), (1,1) and (2,2) are allowed. The other combinations are not allowed and the error message "+CME ERROR: operation not allowed" is returned).

14.8 Set flow control \Q

\Q						
Modules	LEON-G SARA-G					
	LISA-U SARA-U					
Attributes	Syntax	PIN required	Settings saved	Can be aborted	Response time	Error reference
	full	No	No	No	-	+CME Error

14.8.1 Description

Controls the operation of the local flow control between DTE and DCE. It is used when the data are sent or received.

The SW flow control (XON/XOFF) activation is only allowed in case of the text transmission: the binary data cannot be transmitted because it may contain the special flow control characters (XON/XOFF). For SW flow control enhancement, allowing its usage during a PSD call with PPP L2 protocol, refer to the dedicated section ([Chapter 14.5.5](#)) in the AT&K command description.

When the software flow control (XON/XOFF) is used, the DC1 (XON, 0x11) and DC3 (XOFF, 0x13) characters are reserved and therefore filtered (e.g. in SMS text mode these two characters can not be input).

Since the DTE-DCE communication relies on the correct reception of DC1/DC3 characters, the UART power saving should be disabled on the module when SW flow control is used. If the UART power saving is active, the DC1/DC3 characters could be used to wake up the module's UART, and therefore lost. In case a DC3 character (XOFF) is correctly received by module's UART and some data is waiting to be transmitted, the module is forced to stay awake until a subsequent DC1 character (XON) is received.



The software flow control (XON/XOFF) setting is not allowed on the USB interfaces, on the SPI interface and on a multiplexer channel. Refer to [Appendix B.5](#) for all the behavior differences in respect to the supported interfaces.



On the UART interface, if +UPSV is set to 2, only \Q0 (no flow control) is allowed.

14.8.2 Syntax

Type	Syntax	Response	Example
Set	AT\Q[<value>]	OK	AT\Q3 OK

14.8.3 Defined values

Parameter	Type	Description
<value>	Number	<ul style="list-style-type: none"> 0: no flow control 1: DC1/DC3 on circuit 103 and 104 (XON/XOFF) 3 (default value): DCE_by_DTE on circuit 105 (RTS) and DTE_by_DCE on circuit 106 (CTS)

14.9 Fixed DTE rate +IPR

+IPR						
Modules	LEON-G SARA-G					
	LISA-U SARA-U					
Attributes	Syntax	PIN required	Settings saved	Can be aborted	Response time	Error reference
	partial	No	Profile	No	-	+CME Error

14.9.1 Description

Specifies the data rate at which the DCE accepts commands on UART interface. The full range of data rates depends on HW or other criteria.

When supported, the autobauding feature allows baud rate recognition by the DCE in the Offline Command State.



The settings of the command are ignored when the AT command interface runs on the USB port or on the SPI interface. The DCE sends the string "OK" but the command will have no effect.

14.9.2 Syntax

Type	Syntax	Response	Example
Set	AT+IPR=[<rate>]	OK	AT+IPR=9600 OK
Read	AT+IPR?	+IPR: <rate> OK	+IPR: 9600 OK
Test	AT+IPR=?	+IPR: (list of supported autodetectable <rate> values)[,(list of fixed only <rate> values)] OK	+IPR: (0,2400,4800,9600,19200,38400,57600,115200),(OK

14.9.3 Defined values

Parameter	Type	Description
<rate>	Number	Baud rate <ul style="list-style-type: none"> 0 (factory-programmed value): autobauding 1200, 2400, 4800, 9600, 19200, 38400, 57600, 115200, 230400, 460800, 921600

14.9.4 Notes

LISA-U1 / LISA-U200-00S

- Automatic baud rate detection is not implemented (<rate>=0 is not supported)
- The default and the factory-programmed value for <rate> is 115200
- <rate>= 921600 cannot be set as fixed rate.

SARA-G

- On UART AT interface, after the reception of the OK response for the +IPR command, the DTE shall wait for at least 40 ms before issuing a new AT command; this is to guarantee a proper baudrate reconfiguration.
- <rate>= 1200, <rate>= 230400 cannot be set as fixed rate, while <rate>=460800 and <rate>= 921600 are not supported.

LEON-G

- On UART AT interface, after the reception of the OK response for the +IPR command, the DTE shall wait for at least 40 ms before issuing a new AT command; this is to guarantee a proper baudrate reconfiguration.
- <rate>= 1200, <rate>= 230400, <rate>=460800 and <rate>= 921600 cannot be set as fixed rate.



14.9.5 Autobauding description

LISA-U / SARA-U

Only one shot automatic baud rate detection is implemented. If enabled, the module provides autobauding capability only at module start-up, and keeps it active until a first recognition is completed. Later on, it works at the fixed baudrate (the detected one).

- If automatic baud rate detection is set in the active memory profile, the baud rate is detected once at the module power on
- The factory-programmed setting has automatic baud rate detection enabled (<rate> value is 0)
- Since autobauding is implemented as "one shot" autobauding, any setting of +IPR=0 should be avoided; the only exception is in case the autobauding setting has been replaced by a fixed rate setting in the stored profile. In this case the module has started without autobauding and the host needs to reactivate it
- If the module starts with the autobauding active, after the detection, the +IPR read command returns the detected baudrate, while the +IPR value in the active profile (displayed as result of AT&V) does not change (it continues to be 0, otherwise the +IPR setting should be changed every time an AT parameter is changed and the profile saved in the NVM via the AT&W command). As a result, the only way to change the +IPR value in the profile is by issuing an +IPR set command (e.g. AT+IPR=115200 sets a fixed rate on the UART and determines a start-up at a fixed rate of 115200 b/s in case the active profile is saved via AT&W)
- After AT+IPR=0, the run-time configuration of the AT interface is updated (AT&V shows the new setting in the active profile), but the setting is effective only at the next start-up (if and only if the active configuration is saved in the NVM)
- As a consequence of the previous point, if AT+IPR=0 the +IPR read command continues to return the current set baudrate (and not the 0 value). This is an exception and it creates a discrepancy between the value in the profile and the value returned by the +IPR read command, but it allows autobauding re-activation and a coherent result of the +IPR read command
- Autobauding values which can be detected are 1200, 2400, 4800, 9600, 19200, 38400, 57600, 115200, 230400 b/s. This means that baudrate 460800 and 921600 b/s cannot be automatically detected by DCE and must only be set as a fixed rate (via +IPR AT command). AT commands provided with a baudrate other than the stated values lead to unpredictable results
- If the system starts in autobauding (i.e. the +IPR is 0) the first "at" sequence provided to the module detects the baudrate. For example the first command sent from the DTE at any rate can be: AT+CPIN="1234"
Characters different than "AT" are ignored during the baud rate detection since the hardware detection sequence is triggered on the "at" or "AT" sequence. "At" or "aT" sequences are invalid: both detection characters must be small or capital:
 - o The echo is produced or not according to ATE configuration. The echo is only produced for a valid detection string and only after the detection completion, that is there will be a one character delay between the received characters and the echo generation (the echo will start only after "at" or "AT" reception)
 - o The echo is always "AT" regardless of the detection string sent by DTE
 - o The module generates a response for the DTE once autobauding detection is successful, the command has been accepted and the command response is available. Therefore, even if the detection was actually successful a certain amount of time before, it is only possible to assume that the detection phase was successful after a response
 - o If no response is received by the DTE after some time, it must retry (the timeout value should be adjustable inside the DTE application). In any case it is suggested to use a very simple command as the first command, for which the execution time is short and almost constant (e.g. ATE)
- If UART power saving is enabled, the command for the baud rate detection should be sent to the DTE before the module enters idle mode for the first time
- Autobauding result can be unpredictable with spurious characters if power saving is entered and the flow control is disabled. If the hardware flow control is present, the DTE can be synchronized with the power saving cycle through the module CTS line i.e. the delivery of the "AT" sequence during the module wake



up can be granted by the DTE and power saving can be exited correctly. Disable the power saving if no hardware flow control is set at start up

- If automatic baud rate detection is active, greeting messages or URCs before baud rate detection are not sent but buffered. They are sent as first data at the detected baud rate as soon as detection is completed (before any echo of the command or response). The greeting message is sent at the specified baud rate only when the baudrate setting in the profile is other than autobauding
- Data rate 0 also affects the AT+ICF command. Carefully read the description of the AT+ICF command ([Chapter 14.6](#)) for further limitations
- If the parameter is omitted <rate> value is set to 115200

LEON-G / SARA-G

The following notes related to autobauding must be reminded:

- The DCE can start in autobauding (necessary to program the NVM with the baudrate parameter set to 0) or the autobauding can be enabled with the AT+IPR=0 command if the DCE started with a fixed rate
- Autobauding values which can be discovered are the same of the fixing case i.e. 2400, 4800, 9600, 19200, 38400, 57600, 115200 b/s. Although values outside this set will be detected (for ex. 1200 b/s or 230400 Å b/s), AT commands provided with a baudrate other than values declared, leads to unpredictable results
- If the system starts in autobauding (i.e. the +IPR is 0) the first "at" sequence provided to the module detects the baudrate. For example the first command sent from the DTE at any rate can be: AT+CPIN="1234"
- Characters different than AT are ignored during the baud rate detection since the hardware detection sequence is triggered on the "at" or "AT" sequence. "At" or "aT" sequences are invalid too, both of the detection characters must be small or capital
- Power saving is exited at the 'A' (or 'a') character of the autobauding sequence; power save state is re-entered again when the power saving timeout is elapsed, regardless if the baud detection is complete or not. The 'T' (or 't') character does not reset the power saving timer; as a result if the detection completion character is sent outside power save condition, it doesn't force to stay out of power saving state for the number of frames of power saving timer
- Autobauding result can be unpredictable with spurious characters if the power saving is entered and the flow control is disabled. If the hardware flow control is present, the DTE can be synchronized with the power saving cycle through the module CTS line i.e. the delivery of the "AT" sequence during the module awake can be granted by the DTE and the power saving can be exited in the proper way. It is recommended to disable the power saving if no hardware flow control is used
- Data rate 0 affects the AT+ICF command too which value is automatically switched to the 0 value. Read carefully the description of the AT+ICF command for further limitations
- The default value for <rate> is 0
- When autobauding and echo are enabled (+IPR=0, ATE1), there is an hardware loopback between UART TXD and RXD lines until a "AT" (or "at") sequence detection. This means that all the characters before and including the "AT" (or "at") sequence will be retransmitted on the RXD line also if hardware flow control is enabled and the RTS line is OFF.

14.10 System can Return to on-line data state 0

0						
Modules	LEON-G SARA-G					
	LISA-U SARA-U					
Attributes	Syntax	PIN required	Settings saved	Can be aborted	Response time	Error reference
	full	Yes	No	No	-	+CME Error

14.10.1 Description

Causes the DCE to return to online data state and issue a CONNECT or CONNECT <text> (based on ATX command) result code on DTE. It is the complementary command to the escape sequence, or to the other actions (DTR ON to OFF transition, see table in [Chapter 14.3.5](#)) that cause the DCE to switch from online data state to online command state.



ATO command is used to resume both circuit-switched and packet-switched data call. The resume is only possible if the PPP L2 protocol is used.

14.10.2 Syntax

Type	Syntax	Response	Example
Action	ATO	<response>	ATO CONNECT

14.10.3 Defined values

Parameter	Type	Description
<response>	String	<ul style="list-style-type: none"> CONNECT NO CARRIER: the online data state can't be resumed

14.10.4 Notes

- The command provides an error message ("CME ERROR: operation not allowed" if +CMEE is set to 2) in the following cases:
 - The DCE is not in online command state
 - It is issued on a DCE different from the one in online command state
- In case of PSD call, any data from the network (downlink data) received by the DCE during the on-line command state is discarded. This means that after the O command and on-line data state resume, any possible data loss has to be recovered by upper layer protocols (e.g. TCP).

14.11 Escape character S2

S2						
Modules	LEON-G SARA-G LISA-U SARA-U					
Attributes	Syntax	PIN required	Settings saved	Can be aborted	Response time	Error reference
	partial	No	<i>Profile</i>	No	-	<i>+CME Error</i>

14.11.1 Description

Controls the decimal value of the ASCII character used as the escape character. A value greater than 127 disables the escape process, i.e. no escape character will be recognized. The escape sequence contains three escape characters e.g. "+++".

14.11.2 Syntax

Type	Syntax	Response	Example
Set	ATS2=<value>	OK	ATS2=43 OK
Read	ATS2?	<value> OK	043 OK

14.11.3 Defined values

Parameter	Type	Description
<value>	Number	Range 1 to 255. The answer to the read command is in "xxx" format. The default and the factory-programmed value is 43 (ASCII '+').

14.11.4 Notes

The following table shows how the ATS2 command works for different data call scenarios.



Data call command	L2 protocol	Description	ATS2 behavior
AT+CGDATA="M-HEX",1	HEX	u-blox specific	Escape sequence detection is only done for +++ (plus carriage return). ATS2 is not effective. No timing constraints.
AT+CGDATA="M-RAW_IP",1	RAW-IP	PSD call: Transfer IP packet directly	Break detection is not supported
AT+CGDATA="PPP",1	PPP	PSD call: Same of ATD*99***1# (e.g. dial up)	Escape sequence detection is only done for ~+++ . ATS2 is not effective. There is not a timing constraint (see S12 command, Chapter 14.19) for ~+++ (+++ is encapsulated in a PPP frame)
ATD1234		CSD call	The command is effective if issued in both command and online command mode
AT+USODL=0		PSD call: Direct Link mode	The command is effective
AT+USOWR=0,32		PSD call:AT socket (not transparent)	Break detection is not supported

Table 8: ATS2 handling for different data call scenarios

LEON-G / SARA-G

- The <value> parameter is not mandatory.

14.12 Command line termination character S3

S3						
Modules	LEON-G SARA-G LISA-U SARA-U					
Attributes	Syntax	PIN required	Settings saved	Can be aborted	Response time	Error reference
	partial	No	<i>Profile</i>	No	-	<i>+CME Error</i>

14.12.1 Description

Sets a value representing the decimal IRA5 value of the character recognized by the DCE from the DTE, to terminate the incoming command line. It is also generated by the DCE as part of the header, trailer and terminator for result codes and information text, along with the S4 setting.

14.12.2 Syntax

Type	Syntax	Response	Example
Set	ATS3=<value>	OK	ATS3=13 OK
Read	ATS3?	<value> OK	013 OK

14.12.3 Defined values

Parameter	Type	Description
<value>	Number	Range 0 to 127. The answer to the read command is in "xxx" format. The default and the factory-programmed value is 13 (ASCII carriage return (CR, IRA5 0/13)).

14.12.4 Notes

LEON-G / SARA-G

- The <value> parameter is not mandatory.

14.13 Response formatting character S4

S4						
Modules	LEON-G SARA-G					
	LISA-U SARA-U					
Attributes	Syntax	PIN required	Settings saved	Can be aborted	Response time	Error reference
	partial	No	Profile	No	-	+CME Error

14.13.1 Description

Sets a value representing the decimal IRA5 value of the character generated by the DCE as part of the header, trailer and terminator for result codes and information text, along with the S3 setting.

14.13.2 Syntax

Type	Syntax	Response	Example
Set	ATS4=<value>	OK	ATS4=10 OK
Read	ATS4?	<value> OK	010 OK

14.13.3 Defined values

Parameter	Type	Description
<value>	Number	Range 0 to 127. The answer to the read command is in "xxx" format. The default and the factory-programmed value is 10 (line feed (LF, IRA5 0/10)).

14.13.4 Notes

LEON-G / SARA-G

- The <value> parameter is not mandatory.

14.14 Command line editing character S5

S5						
Modules	LEON-G SARA-G					
	LISA-U SARA-U					
Attributes	Syntax	PIN required	Settings saved	Can be aborted	Response time	Error reference
	partial	No	Profile	No	-	+CME Error

14.14.1 Description

Sets a value representing the decimal IRA5 character recognized by the DCE as a request to delete from the command line the immediately preceding character.

14.14.2 Syntax

Type	Syntax	Response	Example
Set	ATS5=<value>	OK	ATS5=8 OK
Read	ATS5?	<value> OK	008 OK

14.14.3 Defined values

Parameter	Type	Description
<value>	Number	Range 0 to 127. The answer to the read command is in "xxx" format. The default and the factory-programmed value is 8 (ASCII backspace (BS, IRA5 0/8)).

14.14.4 Notes

LEON-G / SARA-G

- The <value> parameter is not mandatory.

14.15 Pause before blind dialling S6

S6						
Modules	LEON-G SARA-G					
	LISA-U SARA-U					
Attributes	Syntax	PIN required	Settings saved	Can be aborted	Response time	Error reference
	partial	No	No	No	-	+CME Error

14.15.1 Description

Specifies the time in seconds that the DCE waits between connecting to the line and dialling, when the dial tone is not implemented or enabled. The command is not applicable for signal based mobile phone software.

14.15.2 Syntax

Type	Syntax	Response	Example
Set	ATS6=<value>	OK	ATS6=2 OK
Read	ATS6?	<value> OK	002 OK

14.15.3 Defined values

Parameter	Type	Description
<value>	Number	Range 2 - 10. The answer to the read command is in "xxx" format. The default value is 2 s.

14.15.4 Notes

LEON-G / SARA-G

- The <value> parameter is not mandatory.

14.16 Connection completion timeout S7

S7						
Modules	LEON-G SARA-G					
	LISA-U SARA-U					
Attributes	Syntax	PIN required	Settings saved	Can be aborted	Response time	Error reference
	partial	No	<i>Profile</i>	No	-	+CME Error

14.16.1 Description

Specifies the time in seconds, that the DCE shall allow between either answering a call or completion of dialling and establishment of a connection with a remote site.

14.16.2 Syntax

Type	Syntax	Response	Example
Set	ATS7=<value>	OK	ATS7=30 OK
Read	ATS7?	<value> OK	060 OK

14.16.3 Defined values

Parameter	Type	Description
<value>	Number	Range 1 - 255. The answer to the read command is in "xxx" format. The default and the factory-programmed value is 60 s.

14.16.4 Notes

LEON-G / SARA-G

- The <value> parameter is not mandatory.

14.17 Command dial modifier time S8

S8						
Modules	LEON-G SARA-G					
	LISA-U SARA-U					
Attributes	Syntax	PIN required	Settings saved	Can be aborted	Response time	Error reference
	partial	No	No	No	-	+CME Error

14.17.1 Description

Specifies the amount of time, in seconds, that the DCE shall pause during dialling, when a ',' (comma) dial modifier is encountered in a dial string.



The command has no effect.

14.17.2 Syntax

Type	Syntax	Response	Example
Set	ATS8=<value>	OK	ATS8=4 OK
Read	ATS8?	<value> OK	002 OK

14.17.3 Defined values

Parameter	Type	Description
<value>	Number	Range 0 - 255. The answer to the read command is in "xxx" format. The default value is 2.

14.17.4 Notes

LEON-G / SARA-G

- The <value> parameter is not mandatory.

14.18 Automatic disconnect delay S10

S10						
Modules	LEON-G SARA-G					
	LISA-U SARA-U					
Attributes	Syntax	PIN required	Settings saved	Can be aborted	Response time	Error reference
	partial	No	No	No	-	+CME Error

14.18.1 Description

Specifies the time in tenth of a second, that the DCE will remain connected to the line after the DCE has indicated the absence of received line signal. Not supported for GSM but the OK response is returned.

14.18.2 Syntax

Type	Syntax	Response	Example
Set	ATS10=<value>	OK	ATS10=30 OK
Read	ATS10?	<value> OK	030 OK

14.18.3 Defined values

Parameter	Type	Description
<value>	Number	Range 1 - 254. Default: 1

14.18.4 Notes

LEON-G / SARA-G

- The <value> parameter is not mandatory.

14.19 Escape prompt delay (EPD) S12

S12						
Modules	LEON-G SARA-G					
	LISA-U SARA-U					
Attributes	Syntax	PIN required	Settings saved	Can be aborted	Response time	Error reference
	partial	No	No	No	-	+CME Error

14.19.1 Description

Defines the maximum period, in fiftieths of a second, allowed between the reception of the last character of the sequence of three escape characters from the DTE and the sending of the OK result code to the DTE. If any characters are detected during this time, the OK will not be sent.

Furthermore, the timeout is:

- The minimum period, before the first character reception of the three escape character sequence, during which no other character must be detected to accept it as a valid first character
- The maximum period allowed between receipt of first, or second, character of the three escape character sequence and receipt of the next
- The minimum period, after the last character reception of the three escape character sequence, during which no other character must be detected to accept the escape sequence as a valid one

14.19.2 Syntax

Type	Syntax	Response	Example
Set	ATS12=<value>	OK	ATS12=80 OK
Read	ATS12?	<value> OK	050 OK

14.19.3 Defined values

Parameter	Type	Description
<value>	Number	Range 0 - 255. The answer to the read command is in "xxx" format. The default value is 50 (1 s)

14.19.4 Notes

LEON-G / SARA-G

- The <value> parameter is not mandatory.

14.20 Command echo E

E						
Modules	LEON-G SARA-G					
	LISA-U SARA-U					
Attributes	Syntax	PIN required	Settings saved	Can be aborted	Response time	Error reference
	full	No	<i>Profile</i>	No	-	<i>+CME Error</i>

14.20.1 Description

Controls whether or not the MTEchoes characters received from the DTE during command state.

14.20.2 Syntax

Type	Syntax	Response	Example
Set	ATE[<value>]	OK	ATE1
			OK

14.20.3 Defined values

Parameter	Type	Description
<value>	Number	<ul style="list-style-type: none"> 0: echo off 1 (default and the factory-programmed value): echo on

14.21 Result code suppression Q

Q						
Modules	LEON-G SARA-G					
	LISA-U SARA-U					
Attributes	Syntax	PIN required	Settings saved	Can be aborted	Response time	Error reference
	full	No	<i>Profile</i>	No	-	<i>+CME Error</i>

14.21.1 Description

Determines if DCE transmits result codes to the DTE or not. When result codes are being suppressed, no portion of any intermediate, final or URC is transmitted. Information text transmitted in response to commands is not affected by this setting.

14.21.2 Syntax

Type	Syntax	Response	Example
Set	ATQ[<value>]	OK	ATQ1
			OK

14.21.3 Defined values

Parameter	Type	Description
<value>	Number	<ul style="list-style-type: none"> 0 (default and the factory-programmed value): DCE transmits result codes 1: Result codes are suppressed and not transmitted

14.22 DCE response format V

V						
Modules	LEON-G SARA-G LISA-U SARA-U					
Attributes	Syntax	PIN required	Settings saved	Can be aborted	Response time	Error reference
	full	No	<i>Profile</i>	No	-	<i>+CME Error</i>

14.22.1 Description

Control the contents of the header and trailer transmitted with result codes and information text responses. It also determines whether result codes are transmitted in a numeric form or an alphabetic (or verbose) form. The text portion of information text responses is not affected by this setting. The effect of the command setting on response formats is described below:



Format for information text response:

- for V0: <text><CR><LF>
- for V1: <CR><LF><text><CR><LF>



Format for result codes:

- for V0: <numeric code><CR>
- for V1: <CR><LF><verbose code><CR><LF>

14.22.2 Syntax

Type	Syntax	Response	Example
Set	ATV[<value>]	OK	ATV1 OK

14.22.3 Defined values

Parameter	Type	Description
<value>	Number	<ul style="list-style-type: none"> • 0: DCE transmits limited headers, trailers and numeric text • 1 (default and the factory-programmed value): DCE transmits full headers, trailers and verbose response text

14.23 Result code selection and call progress monitoring control X

X						
Modules	LEON-G SARA-G LISA-U SARA-U					
Attributes	Syntax	PIN required	Settings saved	Can be aborted	Response time	Error reference
	full	No	<i>Profile</i>	No	-	<i>+CME Error</i>

14.23.1 Description

In a CS data call, determines how the DCE transmits to the DTE the CONNECT result code.

14.23.2 Syntax

Type	Syntax	Response	Example
Set	ATX[<value>]	OK	ATX1 OK

14.23.3 Defined values

Parameter	Type	Description
<value>	Number	<ul style="list-style-type: none"> • 0: CONNECT result code is given upon entering online data state; • 1-4: CONNECT <speed> result code is given upon entering online data state; (4 is the default and the factory-programmed value)

Parameter	Type	Description
<speed>	Number	Transfer speed for CSD calls configured via the CBST command

14.24 Reset to default configuration Z

Z						
Modules	LEON-G SARA-G					
	LISA-U SARA-U					
Attributes	Syntax	PIN required	Settings saved	Can be aborted	Response time	Error reference
	full	No	No	No	-	+CME Error

14.24.1 Description

Resets the DCE configuration into a known state; the reset includes the loading of the settings stored in the profile identified by the <value> parameter, into the current profile, and the application of the settings.

When the command is issued, any CSD call in progress is released. In case of success, the result code is issued using the format configuration (Q, V, S3, S4 commands) loaded from the requested profile. The other DCE settings are applied after the result code has been sent.

For more details on the settings stored in the profiles, see the [Appendix B.1](#).

14.24.2 Syntax

Type	Syntax	Response	Example
Action	ATZ[<value>]	OK	

14.24.3 Defined values

Parameter	Type	Description
<value>	Number	Profile index, possible values 0-1; optional parameter, the default value is 0

14.25 Set to factory defined configuration &F

&F						
Modules	LEON-G SARA-G					
	LISA-U SARA-U					
Attributes	Syntax	PIN required	Settings saved	Can be aborted	Response time	Error reference
	full	No	No	No	-	+CME Error

14.25.1 Description

Resets the current profile to factory-defined defaults. Other NVM settings, not included in the profiles, are not affected.

In case of success, the response is issued using the configuration of the result codes format (Q, V, S3 and S4 AT commands) loaded from the factory default profile. The other DCE settings are applied after the response has been sent.

For more details on the settings stored in the profiles, refer to [Appendix B.1](#).

14.25.2 Syntax

Type	Syntax	Response	Example
Action	AT&F[<value>]	OK	

14.25.3 Defined values

Parameter	Type	Description
<value>	Number	Only 0 allowed

14.26 Store current configuration &W

&W						
Modules	LEON-G SARA-G					
	LISA-U SARA-U					
Attributes	Syntax	PIN required	Settings saved	Can be aborted	Response time	Error reference
	full	No	No	No	-	+CME Error

14.26.1 Description

Stores into one of the two RAM profile mirrors the current AT configuration of the DCE interface in which the command is issued. The profile is selected according to the AT command parameter value. For more details on the AT command configuration saved in the profiles, refer to [Appendix B.1](#).

The profile is updated with the RAM mirror only when the module is switched off using the +CPWROFF AT command (more details on the command in the [Chapter 5.2](#)).

14.26.2 Syntax

Type	Syntax	Response	Example
Action	AT&W[<value>]	OK	

14.26.3 Defined values

Parameter	Type	Description
<value>	Number	<ul style="list-style-type: none"> 0 (default value): selects profile 0 1: selects profile 1

14.27 Display current configuration &V

&V						
Modules	LEON-G SARA-G					
	LISA-U SARA-U					
Attributes	Syntax	PIN required	Settings saved	Can be aborted	Response time	Error reference
	full	No	No	No	-	+CME Error

14.27.1 Description

Reports a summary of the current configuration and of the stored user profiles.



Since not all configuration items are listed with this command, see the example below for the list of the displayed configuration items. The complete list of the configuration items stored in the profiles is in [Appendix B.1](#).



AT&V command does not display audio parameters. Audio parameters can be displayed by the corresponding read command (i.e. AT+UMGC?).

14.27.2 Syntax

Type	Syntax	Response	Example
Action	AT&V	ACTIVE PROFILE: List of commands stored in the active profile with the related values STORED PROFILE 0: List of commands stored in the profile 0 with the related values STORED PROFILE 1: List of commands stored in the profile 1 with the related values OK	ACTIVE PROFILE: &C1, &D1, &S1, &K3, E1, Q0, V1, X4, S00:000, S02:043, S03:013, S04:010, S05:008, S07:060, +CBST:007, 000, 001, +CRLP:061, 061, 048, 006, +CR:000, +CRC:000, +IPR:0, +COPS:0, .0, FFFF, +ICF:3, 1, +UPSV: 0, +CMGF:0, +CNMI:1, 0, 0, 0, 0, +USTS: 0 STORED PROFILE 0: &C1, &D1, &S1, &K3, E1, Q0, V1, X4, S00:000, S02:043, S03:013, S04:010, S05:008, S07:060, +CBST:007, 000, 001, +CRLP:061, 061, 048, 006, +CR:000, +CRC:000, +IPR:0, +COPS:0

Type	Syntax	Response	Example
			.0,FFFF, +ICF:3,1, +UPSV: 0, +CMGF:0, +CNMI:1,0,0,0,0, +USTS: 0
			STORED PROFILE 1: &C1, &D1, &S1, &K3, E1, Q0, V1, X4, S00:000, S02:043, S03:013, S04:010, S05:008, S07:060, +CBST:007, 000, 001, +CRLP:061, 061, 048, 006, +CR:000, +CRC:000, +IPR:0, +COPS:0
			.0,FFFF, +ICF:3,1, +UPSV: 0, +CMGF:0, +CNMI:1,0,0,0,0, +USTS: 0
			OK

14.28 Designate a default reset profile &Y

&Y						
Modules	LEON-G SARA-G LISA-U SARA-U					
Attributes	Syntax	PIN required	Settings saved	Can be aborted	Response time	Error reference
	full	No	<i>NVM</i>	No	-	<i>+CME Error</i>

14.28.1 Description

Selects which profile will be loaded at the next power on. The AT commands configuration from the loaded profile will be separately applied to each attached interface. At run time each interface will own the configuration as described in [Appendix B.1](#). An error is returned if <value> is greater than 2, or NVM is not installed or is not operational.

For more details on the commands stored in the profiles, refer to [Appendix B.1](#).

14.28.2 Syntax

Type	Syntax	Response	Example
Action	AT&Y[<value>]	OK	

14.28.3 Defined values



Parameter	Type	Description
<value>	Number	<ul style="list-style-type: none"> 0 (default value and factory-programmed value): selects profile 0 1: selects profile 1 2: selects the factory-programmed settings

14.29 Parity bit transmission over the air +UTPB

+UTPB						
Modules	SARA-G LISA-U200-02S LISA-U200-52S LISA-U200-62S LISA-U200-82S LISA-U260-02S LISA-U270-02S LISA-U270-62S SARA-U					
Attributes	Syntax	PIN required	Settings saved	Can be aborted	Response time	Error reference
	full	No	<i>Profile</i>	No	-	-

14.29.1 Description

Configures the parity bit transmission over the air, for the data received from the DTE during a data call, when the UART interface is programmed for 7 bit data format.

-  The parity bit transmission can only work if the 7 bit data, 1 parity bit, 1 stop bit character framing is set (and thus applies only to UART AT interfaces; refer to +ICF command description).
-  The +UTPB command, like the +ICF command, is only effective on UART AT interfaces. On USB/SPI/MUX interfaces the set command always returns OK and the read command always returns 0.



 The transmission of the parity bit only applies to Circuit Switched data calls or Socket Direct Link; in all the other cases (e.g. PSD dial-up, file write in module FS, any other direct data transmission modes), the parity information is always filtered out.
On LISA-U2 / SARA-U series, the transmission of the parity bit is furtherly restricted to only Circuit Switched data calls (no Socket Direct Link).

 The 7-bit UART configuration has not to be set if the MUX protocol over UART must be activated. Enabling the parity bit transmission during MUX mode does not influence the data transfer, since the assumption is that 7 bit format (7O1, 7E1) is not active. The module does not check if incompatible settings are requested.

14.29.2 Syntax

Type	Syntax	Response	Example
Set	AT+UTPB=<n>	OK	AT+UTPB=1 OK
Read	AT+UTPB?	+UTPB: <n> OK	+UTPB: 1 OK
Test	AT+UTPB=?	+UTPB: (list of supported <n>'s) OK	+UTPB: (0-1) OK

14.29.3 Defined values

 It is possible to enable the transmission of the parity bit even if the frame format on UART is not 7 bit data, 1 parity bit; in such a case the configuration is only applied after the 7 bit format is set on UART (via automatic recognition or +ICF command).

 The +UTPB setting is stored in the profiles (see [Chapter 14.27](#) for more details).

Parameter	Type	Description
<n>	Number	<ul style="list-style-type: none"> 0 (factory-programmed value): The parity bit is not transmitted over the air (MSB of the transmitted byte is always 0) 1: The DCE transmits the parity bit over the air (MSB of the transmitted byte is left untouched)

14.29.4 Notes

- When the DCE's UART detects a parity error in the received data (received parity bit is different from the calculated one) no specific action is taken, i.e. the data are always transmitted over the air.
- When the parity bit over the air is enabled and the UART character format is 7O1, the default escape character "+" (decimal value of ASCII character is 043) has the parity bit set to 1. This prevents DUT on detecting the escape sequence. The user should change the value of escape character with AT+ICF command to a value with parity bit set to 0 (for example character "#", ASCII decimal value 035).
- In case of UART 7O1, 7E1 configuration, data from the network to the DTE must be in the 7-bit format (each byte is binary data in the range 0x00.0x7F); any information carried in the bit at position 7 (bit 0 is LSB, bit 7 is MSB) is ignored by the module, and in any case not transmitted to the DTE since it is replaced by parity information.

14.29.5 AT+UTPB=0 case diagram

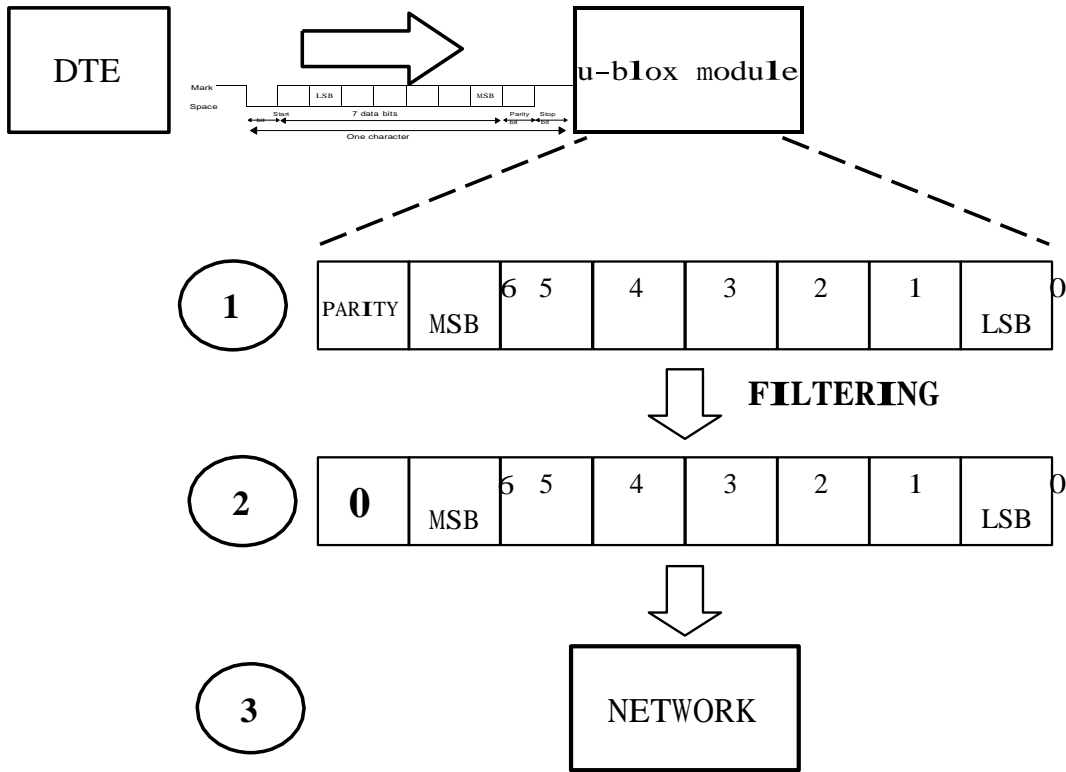

14.29.6 AT+UTPB=1 case diagram

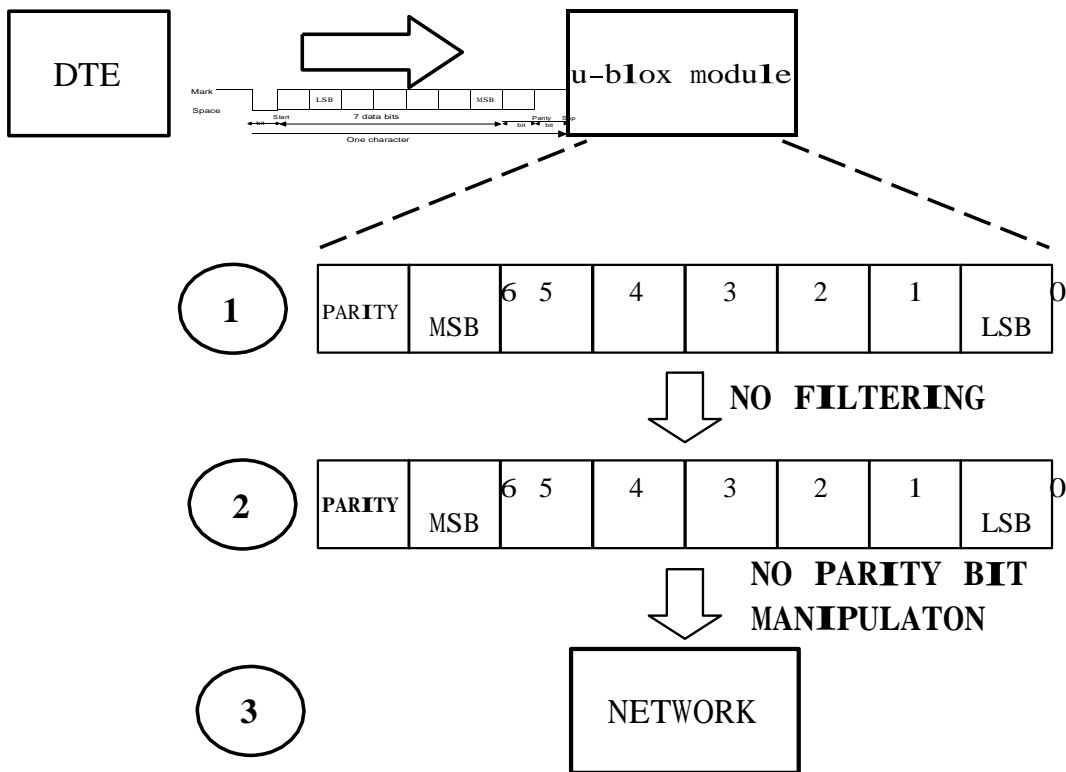

15. SIM management

15.1 Restricted SIM access +CRSM

+CRSM						
Modules	LEON-G SARA-G					
	LISA-U SARA-U					
Attributes	Syntax	PIN required	Settings saved	Can be aborted	Response time	Error reference
	full	Yes	No	No	< 10 s	+CME Error

15.1.1 Description

Allows easy access to the SIM database. The set command transmits the SIM command and its required parameters to the MT. The MT handles internally all SIM-MT interface locking and file selection routines. As response to the command, MT sends the actual SIM information parameters and response data. The MT error result code +CME ERROR may be returned when the command cannot be passed to the SIM, but the failure in the execution of the command in the SIM is reported in <sw1> and <sw2> parameters.

15.1.2 Syntax

Type	Syntax	Response	Example
Set	AT+CRSM=<command>[,<fileid>[,<P1>,<P2>,<P3>[,<data> [,<pathid>]]]]	+CRSM: <sw1>,<sw2>[,<response>] OK	AT+CRSM=176,28471,0,0,3 +CRSM: 144,0,"989301770020594178F2" OK
Test	AT+CRSM=?	OK	OK

15.1.3 Defined values

Parameter	Type	Description
<command>	Number	<ul style="list-style-type: none"> 176: read binary 178: read record 192: get response 214: update binary 220: update record 242: status
<fileid>	Number	Identifies elementary datafile on SIM. Mandatory for every command except STATUS (e.g. 28423: meaning IMSI file (6F07))
<P1>, <P2>, <P3>	Number	Defines the request. These parameters are mandatory for every command, except GET RESPONSE and STATUS. The values are described in GSM TS 11.11 [18] and ETSI TS 102 221 [50].
<data>	String	Information which shall be written to the SIM (hexadecimal character format; refer to +CSCS - string containing hexadecimal characters)
<pathid>	String	Contains the path of an elementary file on the SIM/UICC in hexadecimal format as defined in ETSI TS 102 221 [50] (e.g. "7F205F70" in SIM and UICC case). The <pathid> shall only be used in the mode "select by path from MF" as defined in ETSI TS 102 221 [50]
<sw1>, <sw2>	Number	Contains SIM information about the execution of the actual command and can be (more details in GSM TS 11.11 [18] and ETSI TS 102 221 [50]): <ul style="list-style-type: none"> 0x90 0x00: normal ending of the command 0x9F 0xXX: length XX of the response data 0x92 0x0X: command successful but after using an internal retry routine X times 0x92 0x40: memory problem 0x94 0x00: no EF selected 0x94 0x02: out of range (invalid address) 0x94 0x04: file ID not found; pattern not found 0x94 0x08: file is inconsistent with the command 0x98 0x02: no CHV initialized 0x98 0x04: access condition not fulfilled / unsuccess. CHV verify / authent.failed

Parameter	Type	Description
		<ul style="list-style-type: none"> 0x98 0x08: in contradiction with CHV status 0x98 0x10: in contradiction with invalidation status 0x98 0x40: unsucc. CHV-verif. or UNBLOCK CHV-verif. / CHV blocked /UNBL.blocked 0x98 0x50: increase cannot be performed. Max. value reached 0x67 0xXX: incorrect parameter P3 0x6B 0xXX: incorrect parameter P1 or P2 0x6D 0xXX: unknown instruction code given in the command 0x6E 0xXX: wrong instruction class given in the command 0x6F 0xXX: technical problem with no diagnostic given
<response>	String	The response of successful completion of the command previously issued (hexadecimal character format; refer to +CSCS). STATUS and GET RESPONSE return data, which gives information about the current elementary datafield. This information includes the type of file and its size (refer to GSM TS 11.11 [18] and ETSI TS 102 221 [50]). After READ BINARY or READ RECORD command the requested data will be returned. <response> is not returned after a successful UPDATE BINARY or UPDATE RECORD command.

15.2 Generic SIM access +CSIM

+CSIM						
Modules	LEON-G SARA-G					
	LISA-U SARA-U					
Attributes	Syntax	PIN required	Settings saved	Can be aborted	Response time	Error reference
	full	No	No	No	-	-

15.2.1 Description

Allows direct control of the SIM by a distant application on the TE. This command transparently transmits the <command> to the SIM via the MT. The <response> is returned in the same manner to the TE.



It is recommended to wait some seconds after boot (or reset) before using the command.

15.2.2 Syntax

Type	Syntax	Response	Example
Set	AT+CSIM=<length>,<command>	+CSIM: <length>,<response> OK	AT+CSIM=14,"A0A40000027F20" +CSIM: 4,"6E00" OK
Test	AT+CSIM=?	OK	OK

15.2.3 Defined values

Parameter	Type	Description
<length>	Number	Length of the characters sent to the TE in <command> or <response> parameters
<command>	String	Command passed on by MT to SIM in hex format; see the 3GPP TS 51.011 [18]
<response>	String	Response to the command passed on by the SIM to the MT (3GPP TS 51.011 [18])

15.3 Read the SIM language +CLAN

+CLAN						
Modules	LISA-U SARA-U					
Attributes	Syntax	PIN required	Settings saved	Can be aborted	Response time	Error reference
	full	No	No	No	-	-

15.3.1 Description

Reads the language from the SIM.



The read syntax will display the most preferred language from the preferred language list in EF_{ELP} (2F05) file. If the EF_{ELP} file does not exist, the preferred language is read from EF_{LP} (6F05) file. This file content

is decoded according to the CB (cell broadcast) data coding scheme (dcs), and the according language is displayed in the response string. If this byte does not result in a valid language according to the CB dcs, then it is printed in the response string in hexadecimal representation.

15.3.2 Syntax

Type	Syntax	Response	Example
Read	AT+CLAN?	+CLAN: <code> OK	+CLAN: "en" OK
Test	AT+CLAN=?	OK	

15.3.3 Defined values

Parameter	Type	Description
<code>	String	It is a two-letter abbreviation of the language. The language codes, as defined in ISO 639, consists of two characters, e.g. "en", "it" etc

15.4 Check for UICC card +UICC

+UICC						
Modules	LISA-U SARA-U					
Attributes	Syntax	PIN required	Settings saved	Can be aborted	Response time	Error reference
	full	No	No	No	-	-

15.4.1 Description

Determines if the current SIM is a 2G or 3G SIM.

15.4.2 Syntax

Type	Syntax	Response	Example
Read	AT+UICC?	+UICC: <state> OK	+UICC: 1 OK

15.4.3 Defined values

Parameter	Type	Description
<state>	Number	<ul style="list-style-type: none"> 0: 2G SIM 1: 3G SIM

15.5 Customer service profile +UCSP

+UCSP						
Modules	LISA-U SARA-U					
Attributes	Syntax	PIN required	Settings saved	Can be aborted	Response time	Error reference
	full	No	No	No	-	-

15.5.1 Description

Reads the customer service profile (CSP) from the SIM. The CSP indicates the services that are user accessible.



The syntax +UCSP (if the <service_group> parameter is not issued) displays all the service groups.



If CSP information is not available on the SIM, the error message "+CME ERROR: SIM Failure" is returned when trying to interrogate all or one of the service groups.

15.5.2 Syntax

Type	Syntax	Response	Example
Set	AT+UCSP[=<service_group>]	+UCSP: <service_group>,<services>	AT+UCSP=6

Type	Syntax	Response	Example
		[+UCSP: <service_group>,<services> [...]] OK	+UCSP=6,10000000 OK
Test	AT+UCSP=?	+UCSP: (list of supported <service_group>s) OK	+UCSP: (1-9,c0,d5) OK

15.5.3 Defined values

Parameter	Type	Description
<service_group>	Number	Service group (1-9, c0, d5)
<services>	Number	Services of one service group in bit-format beginning with the most significant bit of the service byte

15.6 SIM hot insertion detection configuration +UDCONF=50

+UDCONF=50						
Modules	LISA-U200-01S LISA-U200-02S LISA-U200-52S LISA-U200-62S LISA-U200-82S LISA-U230 LISA-U260 LISA-U270 SARA-U					
Attributes	Syntax	PIN required	Settings saved	Can be aborted	Response time	Error reference
	full	No	<i>NVM</i>	No	-	<i>+CME Error</i>

15.6.1 Description

Configures the SIM hot insertion detection feature. If enabled, the module is able to monitor the electric line which signals the insertion and removal of a SIM card.



The change in the SIM hot insertion detection is saved in NVM and will be effective at the next power on.

15.6.2 Syntax

Type	Syntax	Response	Example
Set	AT+UDCONF=50,<sim_insertion_detect>	OK	AT+UDCONF=50,1 OK
Read	AT+UDCONF=50	+UDCONF: 50,<sim_insertion_detect> OK	AT+UDCONF=50 +UDCONF: 50,1 OK

15.6.3 Defined values

Parameter	Type	Description
<sim_insertion_detect>	Number	SIM hot insertion detection. Allowed values: <ul style="list-style-type: none"> • 0 (factory-programmed value): SIM insertion detection disabled • 1: SIM insertion detection enabled

16. SIM toolkit

16.1 Introduction

SIM toolkit processing supports two modes: dedicated and raw. Only one mode can be enabled and function at a time.

In dedicated mode, these commands return the output after decoding; in raw mode they deliver the raw output.

The commands in this section only properly work if the SIM toolkit interface has been activated by the DTE. Otherwise the SIM-toolkit processing will be blocked.

The activation of the SIM toolkit interface can be done by:

- AT+CFUN=6 for enabling dedicated mode
- AT+CFUN=9 for enabling raw mode

After the activation of the SIM toolkit interface, the setup menu may be displayed via URC +STKPRO when available from the SIM (immediately or after PIN insertion).



For more details on the command description and parameters, refer to 3GPP TS 51.014 [44].



If an AT command related to dedicated mode is used when raw mode is enabled, an error message ("CME ERROR: operation not allowed" if +CMEE is set to 2) is returned and vice versa.

16.2 Proactive command +STKPRO

+STKPRO						
Modules	LEON-G SARA-G					
	LISA-U SARA-U					
Attributes	Syntax	PIN required	Settings saved	Can be aborted	Response time	Error reference
	partial	Yes	No	No	-	-

16.2.1 Description

The test command displays the list of the proactive commands that need a response from the user/application via +STKTR command. Only the test command syntax is allowed.

During the STK transactions, the URC +STKPRO displays every proactive command.

16.2.2 Syntax

Type	Syntax	Response	Example
Test	AT+STKPRO=?	+STKPRO: (list of supported <proactive_ cmd>s) OK	+STKPRO: (01,05,16,17,18,19,20,21,32, 33,34,35,36,37,38,40,52,53) OK
URC		Generic syntax: +STKPRO: <proactive_cmd>,... Refresh: +STKPRO: 01,<type>,<number of files>, <files> Set up event list: +STKPRO: 05,<event_list> Set up call: +STKPRO: 16,<number>,<subaddr>, <type>,<alpha_1>,<icon_id1>,<alpha_ 2>,<icon_id2> Send SS:	



Type	Syntax	Response	Example
		+STKPRO: 17,<ss_data>,<alpha>,<icon_id>, <ref_number>	
		Send USSD:	
		+STKPRO: 18,<dcs>,<hex_string>,<alpha>,<icon_id>, <ref_number>	
		Send SMS:	
		+STKPRO: 19,<alpha>,<icon_id>,<ref_number>	
		Send DTMF:	
		+STKPRO. 20,<alpha>,<icon_id>,<dtmf_string>	
		Launch browser:	
		+STKPRO: 21,<URL>,<alpha>,<icon_id>	
		Play tone:	
		+STKPRO: 32,<tone>,<unit>,<interval>,<alpha>, <icon_id>	
		Display text:	
		+STKPRO: 33,<type>,<dcs>,<hex_string>,<icon_id>, <imm_resp>	
		Get inkey:	
		+STKPRO: 34,<type>,<dcs>,<hex_string>,<icon_id>	
		Get input:	
		+STKPRO: 35,<type>,<dcs>,<hex_string>, <max_rsp_len>,<min_rsp_len>,<default_text>,<icon_id>	
		Select item:	
		+STKPRO: 36,<type>,<alpha>,<item_id>,<total_items>, <item_text>,<next_action>,<default_item>,<icon_id>,<icon_id_list_element>	
		Set up menu	
		+STKPRO: 37,<type>,<alpha>,<item_id>,<total_items>, <item_text>,<next_action>,<icon_id>,<icon_id_list_element>	
		Provide local info:	
		+STKPRO: 38,<type>	
		Set up idle mode text:	
		+STKPRO: 40,<dcs>,<hex_string>,<icon_id>	
		Run AT command:	
		+STKPRO: 52,<type>,<alpha>,<icon_id>,<at_command>	
		Language notification:	
		+STKPRO: 53,<language>	

16.2.3 Defined values

Parameter	Type	Description
<alpha>, <alpha_1>, <alpha_2>	String	Alpha identifier (used in several proactive commands, see ETSI TS 102 223 [51])
<default_text>	String	Default text for the GET INPUT command (see ETSI TS 102 223 [51])
<dcs>	Number	Data coding scheme
<default_item>	Number	Indication of the default item (see ETSI TS 102 223 [51])



Parameter	Type	Description
<dtmf_string>	String	DTMF tones coded in BCD (same format as the Dialling number string defined for EF _{ADN} in GSM TS 11.11 [18])
<event_list>	Number	Bitmask representing the list of events. See the Table 9 for the meaning of each bit.
<hex_string>	String	Hexadecimal string (the coding is specified in the <dcs> parameter)
<icon_id>, <icon_id1>, <icon_id2>	Number	Icon identifier
<icon_id_list_element>	Number	Item icon identifier
<interval>	Number	Time duration in number of units
<imm_resp>	Number	Immediate response
<item_id>	Number	Identifier of an item within a list
<item_text>	String	Text string of item
<language>	String	2 bytes string indicating the language
<max_rsp_len>	Number	Maximum response length
<min_rsp_len>	Number	Minimum response length
<next_action>	Number	Used only in menu related proactive commands ("set up menu" and "select item") for each item. It gives the possible actions that will be initiated by the SIM Card in case of selection by the user (see ETSI TS 102 223 [51])
<number>	String	Called party number
<proactive_cmd>	Number	<ul style="list-style-type: none">• 01: refresh• 05: set up event list• 16: set up call• 17: send SS• 18: send USSD• 19: send SMS• 20: send DTMF• 21: launch browser• 32: play tone• 33: display text• 34: get inkey• 35: get input• 36: select item• 37: set up menu• 38: provide local info• 40: set up idle mode text• 52: run AT command• 53: language notification
<ref_number>	Number	Reference number
<subaddr>	String	Called party subaddr
<ss_data>	String	Supplementary services string
<type>	Number	Command qualifier
<tone>	Number	<ul style="list-style-type: none">• 01: dial tone• 02: call subscriber busy• 03: congestion• 04: radio path acknowledge• 05: radio path not available• 06: error / special information• 07: call waiting tone• 08: ringing tone• 10: general beep• 11: positive acknowledgement tone• 12: negative acknowledgement or error tone
<total_items>	Number	Total number of the menu items
<unit>	Number	<ul style="list-style-type: none">• 0: minutes• 1: seconds• 2: tenth of seconds
<URL>	String	URL to be loaded
<at_command>	String	AT Command string

16.2.4 Notes

Bit	Event description
0	MT call
1	Call connected
2	Call disconnected
3	Location status
4	User activity
5	Idle screen available
6	Card reader status
7	Language selection
8	Browser termination
9	Data available
10	Channel status
11	Access Technology Change
12	Display parameters changed
13	Local connection
14	Network Search Mode Change
15	Browsing status

Table 9: Event list bit description

LEON-G / SARA-G

- <proactive_cmd>=52 is not supported.

16.3 Terminal response +STKTR

+STKTR						
Modules	LEON-G SARA-G					
	LISA-U SARA-U					
Attributes	Syntax	PIN required	Settings saved	Can be aborted	Response time	Error reference
	partial	Yes	No	No	< 20 s	+CME Error

16.3.1 Description

Allows entering response to a SIM toolkit proactive command displayed by the **+STKPRO** URC.

If no response is entered, after a timeout of duration may range from 180 to 300 s, the module sends an autonomous terminal response to the SIM to complete the STK transaction; the result depends on the pending proactive command and can be "Command performed successfully", "No response from user", "Command type not understood by ME" or "Command data not understood by ME" (see 3GPP TS 51.014 [44]).

The command must be always entered, to terminate the pending STK session at the MT-TE interface, and to be able to enter additional STK commands.

The set command syntax depend on the <proactive_cmd> value.

 *0 stands for the obsolete parameter <last_cmd>.

 It can be used only if the SIM toolkit interface is enabled in dedicated mode.

16.3.2 Syntax

Type	Syntax	Response	Example
Set	Generic syntax: AT+STKTR=<proactive_cmd>[,<type>] [,<result>,<add_result>[,<reference_number>]][,<last_cmd>][,<dc>][,<hex string>]]	OK	AT+STKTR=1,0 OK
Refresh:		OK	



Type	Syntax	Response	Example
	AT+STKTR=01,<result>[,<add_result>]		
	Set up event list:	OK	
	AT+STKTR=05,<result>		
	Set up call:	OK	
	AT+STKTR=16,<result>[,<add_result>]		
	Send SS:	OK	
	AT+STKTR=17,<result>,<add_result>[,<reference_number>]		
	Send USSD:	OK	
	AT+STKTR=18,<result>,<add_result>[,<reference_number>]		
	Send SMS:	OK	
	AT+STKTR=19,<result>,<add_result>[,<reference_number>]		
	Send DTMF:	OK	
	AT+STKTR=20,<result>[,<add_result>]		
	Launch browser:	OK	
	AT+STKTR=21,<result>		
	Play tone:	OK	
	AT+STKTR=32,<result>,<add_result>		
	Display text:	OK	
	AT+STKTR=33,<result>,<add_result>		
	Get inkey:	OK	
	AT+STKTR=34,<result>,<add_result>,0,<dcs>,<hex_string>		
	Get input:	OK	
	AT+STKTR=35,<result>,<add_result>,0,<dcs>,<hex_string>		
	Select item:	OK	
	AT+STKTR=36,<result>,<add_result>,0,<dcs>,<hex_string>		
	Set up menu:	OK	
	AT+STKTR=37,<result>,<add_result>		
	Provide local info (language setting):	OK	
	AT+STKTR=38,<result>,<language>		
	Set up idle mode text:	OK	
	AT+STKTR=40,<result>,<add_result>		
	Run AT command:	OK	
	AT+STKTR=52,<result>,<add_result>,0,<dcs>,<hex_string>		
	Language notification:	OK	
	AT+STKTR=53,<result>,<add_result>		
Test	AT+STKTR=?	+STKTR: (list of supported <proactive_cmd> values) OK	+STKTR: (01,05,16,17,18,19,20,21,32,33,34,35,36,37,38,40,52,53) OK

16.3.3 Defined values

Parameter	Type	Description
<proactive_cmd>	Number	Decimal code indicates the command (refer to the +STKPRO command description)
<result>	Number	<ul style="list-style-type: none"> 0: command performed successfully 1: command performed with partial comprehension 2: command performed with missing information



Parameter	Type	Description
		<ul style="list-style-type: none"> 3: REFRESH performed with additional EFs read 4: command performed successfully, but requested icon could not be displayed 5: command performed but modified by call control by SIM 6: command performed successfully, limited service 7: command performed with modification 16: proactive SIM session terminated by the user 17: backward move in the proactive SIM session requested by the user 18: no response from user 19: help information required by the user 20: USSD or SS transaction terminated by the user 32: MT currently unable to process command 33: network currently unable to process command 34: user did not accept call set-up request 35: user cleared down call before connection or network release 36: action in contradiction to the current timer state 37: interaction with call control by SIM, temporary problem 38: launch browser generic error code 48: command beyond MT's capabilities 49: command type not understood by MT 50: command data not understood by MT 51: command number not known by MT 52: run AT command 53: SMS RP-ERROR 54: error, required values are missing 55: USSD return error 56: MultipleCard commands error, if class 'a' is supported 57: interaction with call control by SIM or MO short message control by SIM, permanent problem 58: bearer independent protocol error (if class 'e' is supported)
<add_result>	Number	Additional information, required with specific result codes and/or proactive commands
<reference_number>	Number	Number containing the indicated reference number; this parameter can be used only in case of <proactive_cmd> related to SMS, SS, USSD
<dcsc>	Number	Data coding scheme
<hex_string>	String	Default item (see item_id)
<language>	String	Decimal value of the ISO 639 language code. E.g. German language is coded as "de" in ISO 639. Thus 0x6465 has to be converted in decimal: <language>=25701
<last_cmd>	Number	Obsolete parameter, to be set to 0

16.3.4 Notes

LISA-U / SARA-U

- <reference_number> is not supported.

LEON-G / SARA-G

- <proactive_cmd>=53 is not supported; in this case, the terminal response is automatically sent by the MT.

16.4 Envelope +STKENV

+STKENV						
Modules	LEON-G SARA-G					
	LISA-U SARA-U					
Attributes	Syntax	PIN required	Settings saved	Can be aborted	Response time	Error reference
	full	Yes	No	No	< 20 s	+CME Error

16.4.1 Description

Allows encoding and sending an STK envelope command to the SIM.

 Can be used only if the SIM toolkit interface is enabled in dedicated mode.

16.4.2 Syntax

Type	Syntax	Response	Example
Set	AT+STKENV=<envelope_cmd>,<opt_ENV_data1>,<opt_ENV_data2>	OK	AT+STKENV=211,01 OK
Test	AT+STKENV=?	+STKENV: (list of supported <envelope_cmd> OK	+STKENV: 211,214 OK

16.4.3 Defined values

Parameter	Type	Description
<envelope_cmd>	Number	<ul style="list-style-type: none"> code 211 (0xD3): Menu selection (<opt_ENV_data1> shall specify the item identifier of startup menu list) code 214 (0xD6): Event download (<opt_ENV_data1> shall specify the <event_list>, in which only one event can be included)
<opt_ENV_data1>	Number	Command code related parameters and can have the following values, depending on the chosen envelope command: <ul style="list-style-type: none"> If <envelope_cmd>=211, "item identifier" If <envelope_cmd>=214 (event list), <ul style="list-style-type: none"> 4: user activity 5: idle screen available 7: language selection 8: browser termination
<opt_ENV_data2>	Number	Meaning depends on the chosen envelope command: <ul style="list-style-type: none"> If <envelope_cmd>=211, "help requested" with the following encoding: <ul style="list-style-type: none"> 0: help is not requested 1: help is requested If <envelope_cmd>=214 and <opt_ENV_data1>=7, "currently used language in the DTE" (see AT+STKTR=38) If <envelope_cmd>=214 and <opt_ENV_data1>=8, "provide the cause" with the following allowed values: <ul style="list-style-type: none"> 00: User Termination 01: Error Termination

16.5 Terminal profile +STKPROF

+STKPROF						
Modules	LEON-G SARA-G LISA-U SARA-U					
Attributes	Syntax	PIN required	Settings saved	Can be aborted	Response time	Error reference
	full	Yes	No	No	-	+CME Error

16.5.1 Description

Allows reading and changing the terminal profile (list of SIM Application Toolkit facilities supported by the terminal, see ETSI TS 102 223 [51]) data stored in NVM and used only at SIM initialization. The SIM card may use this information to filter the proactive commands sent to the module. This command does not actually remove/add any functionality from/to the module.

 Can be used only if the SIM toolkit interface is enabled in dedicated mode.

16.5.2 Syntax

Type	Syntax	Response	Example
Set	AT+STKPROF=<length>,<data>	OK	AT+STKPROF=2,"1F7F"

Type	Syntax	Response	Example
Read	AT+STKPROF?	+STKPROF: <length>,<data> OK	+STKPROF:17,"FFFFFFFFF7F0300DF7F0000000010A0003" OK
Test	AT+STKPROF=?	OK	

16.5.3 Defined values

Parameter	Type	Description
<length>	Number	Length in bytes of data sent to DTE in <data>
<data>	String	Terminal profile data coded in hex format

16.5.4 Notes

- <length> set to 0 forces a reset to the default terminal profile stored in the MT.

16.6 Call and short message control URC +STKCC

+STKCC	
Modules	LEON-G SARA-G LISA-U SARA-U

16.6.1 Description

The indication of the call control and short message control by SIM (see 3GPP TS 51.014 [44]) is performed using the URC +STKCC.



Present only if the SIM toolkit interface is enabled in dedicated mode.

16.6.2 Syntax

Type	Syntax	Response	Example
URC		+STKCC: <cc_command>,<res_val>,<alpha>,<param1>[,<sc_addr>,<ton_npi>,<dest_addr>]	+STKCC: 1,0,"Calling","+3913456890"

16.6.3 Defined values

Parameter	Type	Description
<cc_command>	Number	<ul style="list-style-type: none"> • 1: set up call • 2: send SS • 3: send USSD • 4: send SMS
<res_val>	Number	Call control result value <ul style="list-style-type: none"> • 00: Allowed, no modification • 01: Not allowed • 02: Allowed with modification
<alpha>	String	
<param1>	String	<ul style="list-style-type: none"> • called party number if <cc_command>=1 • supplementary service string if <cc_command>=2 • USSD control string if <cc_command>=3 • type of number and numbering plan if <cc_command>=4
<sc_addr>	String	Service centre address
<ton_npi>	Number	Type of number and numbering plan
<dest_addr>	String	Destination address

16.7 Proactive session status URC +STKCNF

+STKCNF	
Modules	LEON-G SARA-G LISA-U SARA-U

16.7.1 Description

The STK proactive session status is displayed using this URC +STKCNF. The URC comes out after the AT +STKTR or the AT+STKENV command has been issued. Refer to [Chapter 16.3](#) and [Chapter 16.4](#) for the related command descriptions.

 Present only if the SIM-toolkit interface is enabled in dedicated mode.

16.7.2 Syntax

Type	Syntax	Response	Example
URC		+STKCNF: <proactive_cmd>,<result>,<add_result>,<sw1>	+STKCNF: 37,0,255,144

16.7.3 Defined values

Parameter	Type	Description
<proactive_cmd>	Number	Decimal code indicating the command that was finished (refer to +STKPRO command Chapter 16.2); 129 (0x81) indicates the end of active session.
<result>	Number	Additional result code (refer to 3GPP 51.014 specification [44]); if no additional information is available 255 (0xFF) is returned
<add_result>	Number	Additional result code; 255 (0xFF) is returned if no additional information is available
<sw1>	Number	Status of the last response <ul style="list-style-type: none"> • 144 (0x90): command executed successfully • 0: command to SIM was suppressed because of multiple terminal response or wrong client • For other responses see 3GPP TS 51.011 [18]

16.8 Envelope download in raw mode +SATE

+SATE						
Modules	LISA-U SARA-U					
Attributes	Syntax	PIN required	Settings saved	Can be aborted	Response time	Error reference
	full	Yes	No	No	< 20 s	+CME Error

16.8.1 Description

Sends the raw envelope data to the SIM.

 Can be used only if the SIM toolkit interface is enabled in raw mode.

16.8.2 Syntax

Type	Syntax	Response	Example
Set	AT+SATE=<text>	+SATE: <sw1>,<sw2>,<envelope_type>,<event_type> OK	AT+SATE="d30782020181900101" +SATE: 145,111,211,255 OK

16.8.3 Defined values

Parameter	Type	Description
<text>	String	Raw envelope data in Hex value
<sw1>	Number	Status of the last response <ul style="list-style-type: none"> • 144 (0x90): command executed successfully • 0: command to SIM was suppressed because of multiple terminal response or wrong client

Parameter	Type	Description
		For other responses see 3GPP TS 51.011
<sw2>	Number	Specifies the additional information depending on <sw1>
<envelope_type>	Number	<ul style="list-style-type: none"> • 211 (0xD3): Menu selection • 214 (0xD6): Event download
<event_type>	Number	If <envelope_type>=214 (event list), <ul style="list-style-type: none"> • 4: user activity • 5: idle screen available • 7: language selection • 8: browser termination

16.9 Proactive command indication in raw mode +SATI

+SATI	
Modules	LEON-G SARA-G LISA-U SARA-U

16.9.1 Description

Communicates to the user the proactive command, in raw mode, coming from SIM.

The module expects a terminal response to be sent; the user shall respond with AT+SATR for sending the terminal response.

 Can be used only if the SIM toolkit interface is enabled in raw mode.

16.9.2 Syntax

Type	Syntax	Response	Example
URC		+SATI: <text>	+SATI: "D020810301250082028182050 C53544B2D4A617661436172648F030 141411E020001"

16.9.3 Defined values

Parameter	Type	Description
<text>	String	Raw proactive command data in Hex value

16.10 Proactive command indication in raw mode +SATN

+SATN	
Modules	LEON-G SARA-G LISA-U SARA-U

16.10.1 Description

Sends the proactive command in raw mode to the user in case the module handles the proactive command.

For this URC, the module does not expect any terminal response from the user, since the TERMINAL RESPONSE to SIM shall be sent internally.

 Present only if the SIM toolkit interface is enabled in raw mode.

16.10.2 Syntax

Type	Syntax	Response	Example
URC		+SATN: <text>	+SATN: "D01A8103011000820281830 50A63616C6C696E672E2E2E860 38121F3"

16.10.3 Defined values

Parameter	Type	Description
<text>	String	Raw proactive command data in Hex value

16.11 Send terminal response in raw mode +SATR

+SATR						
Modules	LISA-U SARA-U					
Attributes	Syntax	PIN required	Settings saved	Can be aborted	Response time	Error reference
	full	Yes	No	No	< 20 s	+CME Error

16.11.1 Description

Used to send the terminal response when +SATI URC is received by the user. It sends the Terminal Response in raw mode to the SIM.



Can be used only if the SIM toolkit interface is enabled in raw mode.

16.11.2 Syntax

Type	Syntax	Response	Example
Set	AT+SATR=<text>	OK	AT+SATR="810301240082028281830100900101" OK

16.11.3 Defined values

Parameter	Type	Description
<text>	String	Raw terminal response data in Hex value

16.12 Terminal response confirmation +SATF

+SATF	
Modules	LEON-G SARA-G LISA-U SARA-U

16.12.1 Description

Provides the response to a terminal response (sent by the user or automatically by the module) from the SIM.



Present only if the SIM toolkit interface is enabled in raw mode.

16.12.2 Syntax

Type	Syntax	Response	Example
URC		+SATF: <sw1>,<sw2>	+SATF: 144,0

16.12.3 Defined values

Parameter	Type	Description
<sw1>	Number	Status of the last response <ul style="list-style-type: none"> 144 (0x90): command successfully executed 0: command to SIM was suppressed because of multiple terminal response or wrong client For other responses see 3GPP TS 51.011
<sw2>	Number	The second status byte specifies additional information depending on <sw1>

16.13 User confirmation for SET UP call in raw mode +SATD

+SATD						
Modules	LISA-U SARA-U					
Attributes	Syntax	PIN required	Settings saved	Can be aborted	Response time	Error reference
	full		Yes	No	No	< 20 s

16.13.1 Description

SATD Set command is used for USER CONFIRMATION required for SET UP CALL proactive command. User can accept the call or reject the call.

SATD is used as response to +SATN URC sent to the user for SET UP CALL Proactive command.



Can be used only if the SIM toolkit interface is enabled in raw mode.

16.13.2 Syntax

Type	Syntax	Response	Example
Set	AT+SATD=<user_confirmation>	OK	AT+SATD=1 OK
Test	AT+SATD=?	+SATD: (list of supported <user_confirmation>'s) OK	+SATD: (0,1) OK

16.13.3 Defined values

Parameter	Type	Description
<user_confirmation>	Number	<ul style="list-style-type: none"> 0: reject the call 1: accept the call

16.14 Indication for Mo Call Control / Mo SMS Control +STKCTRLIND

+STKCTRLIND						
Modules	LISA-U SARA-U					
Attributes	Syntax	PIN required	Settings saved	Can be aborted	Response time	Error reference
	full		No	No	No	-

16.14.1 Description

Lists the supported call/SMS control type.

+STKCTRLIND is an unsolicited indication for MO Call Control and MO SMS Control.



Present only if the SIM toolkit interface is enabled in raw mode.

16.14.2 Syntax

Type	Syntax	Response	Example
Test	AT+STKCTRLIND=?	+STKCTRLIND: (range of supported <type>) OK	+STKCTRLIND: (0-3) OK
URC		"set up call" type: +STKCTRLIND: 0, <result>, <alpha_id>, <destination_address>, <destination_address_type> "send SS" type:	



Type	Syntax	Response	Example
		+STKCTRLIND: 1, <result>, <alpha_id>, <destination_address>, <destination_address_type> "send USSD" type: +STKCTRLIND: 2, <result>, <alpha_id>, <dc>, <data> "send SMS" type: +STKCTRLIND: 3,<result>,<alpha_id>, <destination_address>,<destination_address_type>, <service_center_address>,<service_center_address_type>	

16.14.3 Defined values

Parameter	Type	Description
<type>	Number	<ul style="list-style-type: none"> 0: setup call 1: send SS 2: send USSD 3: send SMS
<result>	Number	<ul style="list-style-type: none"> 0: The request is allowed without modifications 1: The request is not allowed. No action shall be performed. 2: The request is modified, but allowed. The modified values shall be used. 254: The toolkit is busy. The request shall be repeated later without taking any action in between. 255: error happened
<alpha_id>	String	Alpha identifier
<destination_address>	String	Dialling Number
<destination_address_type>	Number	Type of number and numbering plan
<service_center_address>	String	Service centre address
<service_center_address_type>	Number	Type of number and numbering plan
<dc>	Number	Data Coding Scheme
<data>	String	USSD String

17. Packet switched data services

17.1 Common parameters definition

17.1.1 <APN>

The Access Point Name (APN) is a string parameter, which is a logical name, valid in the current PLMN's domain, used to select the GGSN (Gateway GPRS Support Node) or the external packet data network to be connected to. The APN can be omitted: this is the so-called "blank APN" setting that may be suggested by network operators (e.g. to roaming devices); in this case the APN string is not included in the message sent to the network.

An optional special code placed at the beginning of <APN> indicates the type of authentication handling between the module and the network and may be:

- CHAP: challenge handshake authentication protocol
- PAP: personal authentication protocol
- NOAUTH: authentication protocol not used
- code omitted: authentication protocol not used

An example for the usage of <APN> is:

```
AT+CGDCONT=1,"IP","CHAP:internet.t-d1.de"
```

The maximum length of the parameter is 99.

17.1.2 <cid>

PDP context identifier. A numeric parameter specifying a particular PDP context definition. This parameter is valid only locally on the interface DTE-MT.

The maximum number of definable PDP contexts is 11. The maximum number of active PDP contexts is 3.



LEON-G / SARA-G / LISA-U1 / LISA-U200-00S / LISA-U2x0-x1S
The maximum number of definable PDP contexts is 3.



LISA-U200-62S
The maximum number of definable PDP contexts is 10.

17.1.3 <d_comp>

Numeric parameter specifying the PDP data compression; it can have the values:

- 0 (default value): off
- 1: on (predefined compression type i.e. V.42bis data compression)
- 2 : V.42bis data compression



LEON-G / SARA-G
<d_comp>=1 and <d_comp>=2 are not supported (<d_comp>=1 may be accepted, but no compression is performed).

17.1.4 <delay>

Numeric parameter which specifies the delay class according to 3GPP TS 24.008 [30] (QoS) (for the description refer to the [+UPSD](#) command description).

17.1.5 <Delivery_of_erroneous_SDUs>

Numeric parameter indicating whether SDUs (Service Data Unit) detected as erroneous shall be delivered or not (refer to 3GPP TS 24.008 [30], subclause 10.5.6.5):



- 0: no
- 1: yes
- 2: no detect
- 3 (default value): subscribed value

17.1.6 <Delivery_order>

Numeric parameter that indicates whether the UMTS bearer shall provide in-sequence SDU (Service Data Unit) delivery or not (refer to 3GPP TS 24.008 [30], subclause 10.5.6.5):

- 0: no
- 1: yes
- 2: subscribed value

17.1.7 <destination_port_range>

String parameter given as dot-separated numbers on the form "f.t" that specifies the destination port range attribute of a valid packet filter:

- Range: 0-65535

17.1.8 <evaluation_precedence_index>

Numeric parameter that identifies an evaluation precedence index that is unique within all TFTs associated with the PDP contexts that share the same PDP address

- Range: 0-255 (from highest evaluation precedence to lowest evaluation precedence)

17.1.9 <Guaranteed_bitrate_DL>

Numeric Parameter that indicates the maximum number of kb/s delivered to UMTS (DL) at an application processor (refer to 3GPP TS 24.008 [30], subclause 10.5.6.5):

- Range 1-63 in steps of 1
- Range 64-568 in steps of 8
- Range 576-8640 in steps of 64
- Range 8700-16000 in steps of 100
- Range 17000-128000 in steps of 1000
- Range 130000-256000 in steps of 2000

17.1.10 <Guaranteed_bitrate_UL>

Numeric parameter indicating the maximum number of kb/s delivered to UMTS (UL) at an application processor (refer to 3GPP TS 24.008 [30], subclause 10.5.6.5):

- Range 1-63 in steps of 1
- Range 64-568 in steps of 8
- Range 576-8640 in steps of 64
- Range 8700-16000 in steps of 100
- Range 17000-128000 in steps of 1000
- Range 130000-256000 in steps of 2000

17.1.11 <h_comp>

Numeric parameter specifying the PDP header compression; it can have the values:

- 0 (default value): off
- 1: on (predefined compression type, i.e. RFC1144)
- 2: RFC1144

- 3: RFC2507
- 4: RFC3095



LEON-G / SARA-G

<h_comp>= 2, 3 and 4 are not supported.

17.1.12 <ipsec_security_parameter_index_(spi)>

Numeric parameter that specifies the IPSec SPI attribute of a valid packet filter which is a 32-bit field.

- Range: 0x00000000 - 0xFFFFFFFF

17.1.13 <L2P>

String parameter indicating the layer 2 protocol to be used between the DTE and MT; these values are supported:

- "PPP" (default value)
- "M-HEX"
- "M-RAW_IP"
- "M-OPT-PPP"
- "M-PPP-RELAY" (only on LISA-U200-62S series)



LEON-G / SARA-G

<L2P>= "M-OPT-PPP" is not supported.

17.1.14 <Maximum_bitrate_DL>

Numeric parameter indicating the maximum number of kb/s delivered to UMTS (DL) at an application processor (refer to 3GPP TS 24.008 [30], subclause 10.5.6.5):

- Range 1-63 in steps of 1
- Range 64-568 in steps of 8
- Range 576-8640 in steps of 64
- Range 8700-16000 in steps of 100
- Range 17000-128000 in steps of 1000
- Range 130000-256000 in steps of 2000

17.1.15 <Maximum_bitrate_UL>

Numeric parameter indicating the maximum number of kb/s delivered to UMTS (UL) at an application processor (refer to 3GPP TS 24.008 [30], subclause 10.5.6.5):

- Range 1-63 in steps of 1
- Range 64-568 in steps of 8
- Range 576-8640 in steps of 64
- Range 8700-16000 in steps of 100
- Range 17000-128000 in steps of 1000
- Range 130000-256000 in steps of 2000

17.1.16 <Maximum_SDU_size>

Numeric parameter that indicates the maximum allowed SDU (Service Data Unit) size in octets (refer to 3GPP TS 24.008 [30], subclause 10.5.6.5):

- 0: subscribed value
- Range 10-1500 in steps of 10 octets
- 1502
- 1510
- 1520

17.1.17 <mean>

Numeric parameter specifying the mean throughput class (for the description refer to the [+UPSD](#) command description)

17.1.18 <p_cid>

Numeric parameter that identifies the particular PDP context definition, specified using +CGDCONT, to which a secondary PDP context definition will be associated using +CGDSCONT.

This parameter is only locally valid on the interface TE-MT.

17.1.19 <packet_filter_identifier>

Numeric parameter that identifies a packet filter:

- Range: 1 - 8

17.1.20 <peak>

Numeric parameter specifying the peak throughput class (for the description refer to the [+UPSD](#) command description)

17.1.21 <PDP_addr>

String parameter identifying the MT in the IP-address space applicable to the PDP service. If the value is null or omitted, then a value may be provided by the DTE during the PDP startup procedure or, failing that, a dynamic address will be requested. It can be read with the command AT+CGPADDR.

Depending on the IP-version, the <PDP_addr> consists of 4 octets (IPv4) or 16 octets (IPv6):

- IPv4: "ddd.ddd.ddd.ddd"
- IPv6: "ddd.ddd.ddd.ddd.ddd.ddd.ddd.ddd.ddd.ddd.ddd.ddd.ddd.ddd"

 LEON-G / SARA-G / LISA-U

The IPv6 version is not supported.

17.1.22 <PDP_type>

The Packet Data Protocol (PDP) type is a string parameter which specifies the type of packet data protocol:

- IP: Internet Protocol (IETF STD 5)
- PPP: Point to Point Protocol (only on LISA-U200-62S series)

17.1.23 <precedence>

Numeric parameter specifying the precedence class (for the description refer to the [+UPSD](#) command description), it can assume the values:

- 0: network subscribed
- 1: high priority
- 2: normal priority
- 3: low priority

17.1.24 <reliability>

Numeric parameter specifying the reliability class (refer to the [+UPSD](#) command description)

17.1.25 <state>

Indicates the state of GPRS attachment

- 0: detached
- 1 (default value): attached

17.1.26 <status>

Indicates the state of PDP context activation



- 0: deactivated
- 1: activated



<h_comp>: the available head-compressions is depending on configuration of the stack (configured via features in the stack)



<L2P>: the application on the remote side must support the selected protocol as well.

17.1.27 <Traffic_class>

Indicates the application type for which the UMTS bearer service is optimized (refer to 3GPP TS 24.008 [30], subclause 10.5.6.5):

- 0: conversational
- 1: streaming
- 2: interactive
- 3: background
- 4: subscribed value



If the traffic class is specified as conversational (<Traffic_class>=0) or streaming (<Traffic_class>=1), then the Guaranteed and Maximum bit rate parameters shall be also provided.

17.1.28 <SDU_error_ratio>

Indicates the target value for the fraction of SDUs (Service Data Unit) lost or detected as erroneous. SDU error ratio is defined only for conforming traffic (refer to 3GPP TS 24.008 [30], subclause 10.5.6.5). The value is specified as 'mEe', e.g. a target SDU error ratio of $1*10^{-6}$ would be specified as '1E6'

- "1E6": $1*10^{-6}$
- "1E5": $1*10^{-5}$
- "1E4": $1*10^{-4}$
- "1E3": $1*10^{-3}$
- "7E3": $7*10^{-3}$
- "1E2": $1*10^{-2}$
- "1E1": $1*10^{-1}$
- "0E0": subscribed value

17.1.29 <Residual_bit_error_ratio>

Indicates the target value for the undetected bit error ratio in the delivered SDUs (Service Data Unit). If no error detection is requested, the parameter indicates the bit error ratio in the delivered SDUs (refer to 3GPP TS 24.008 [30], subclause 10.5.6.5). The value is specified as 'mEe', e.g. a target SDU error ratio of $5*10^{-2}$ would be specified as '5E2'

- "6E8": $6*10^{-8}$
- "1E6": $1*10^{-6}$
- "1E5": $1*10^{-5}$
- "1E4": $1*10^{-4}$
- "5E3": $5*10^{-3}$
- "4E3": $4*10^{-3}$
- "1E3": $1*10^{-3}$
- "5E2": $5*10^{-2}$
- "1E2": $1*10^{-2}$
- "0E0": subscribed value

17.1.30 <Transfer_delay>

Indicates the target time, in milliseconds, between a request to transfer an SDU (Service Data Unit) at an application processor and its delivery at the other application processor (refer to 3GPP TS 24.008 [30], subclause 10.5.6.5):

- Range 10-150 in steps of 10

- Range 200-950 in steps of 50
- Range 1000-4000 in steps of 100

17.1.31 <Traffic_handling_priority>

Specifies the relative importance for handling of all SDUs (Service Data Unit) belonging to the UMTS bearer compared to the SDUs of other bearers (refer to 3GPP TS 24.008 [30], subclause 10.5.6.5):

- 0: subscribed
- 1: Priority level 1
- 2: Priority level 2
- 3: Priority level 3

17.1.32 <source_address_and_subnet_mask>

Specifies the source address and subnet mask attribute of a valid packet filter. Consists of dot-separated numeric (0-255) parameters on the form:

- "a1.a2.a3.a4.m1.m2.m3.m4" for IPv4
- "a1.a2.a3.a4.a5.a6.a7.a8.a9.a10.a11.a12.a13.a14.a15.a16.m1.m2.m3.m4.m5.m6.m7.m8.m9.m10.m11.m12.m13.m14.m15.m16" for IPv6



LEON-G / SARA-G / LISA-U

The IPv6 version is not supported.

17.1.33 <protocol_number_(ipv4)-next_header_(ipv6)>

Specifies the Protocol Number / Next Header attribute of a valid packet filter. It shall contain either an IPv4 Protocol Number or an IPv6 Next Header value.

- Range: 0 -255



LEON-G / SARA-G / LISA-U

The IPv6 version is not supported.

17.1.34 <source_port_range>

String parameter given as dot-separated numbers on the form "f.t" that specifies the source port range attribute of a valid packet filter:

- Range: 0-65535

17.1.35 <type_of_service_(tos)_(ipv4)_and_mask-traffic_class_(ipv6)_and_mask> String parameter given as dot-separated numbers on the form "t.m" that specifies the Type of Service / Traffic Class and Mask attribute of a valid packet filter. It shall contain either an IPv4 TOS octet or an IPv6 Traffic Class octet along with a mask defining which of the 8 bits should be used for matching.

- Range: 0-65535



LEON-G / SARA-G / LISA-U

The IPv6 version is not supported.

17.1.36 <flow_label_(ipv6)>

Specifies the Flow Label attribute of a valid packet filter. It shall contain an IPv6 flow label, which is a 20-bit field. It is valid for IPv6 only

- Range: 0x00000 - 0x FFFFF



LEON-G / SARA-G / LISA-U

The IPv6 version is not supported.

17.1.37 <Source_Statistic_Descriptor>

Specifies the characteristics of the source of the submitted SDUs for a PDP context.

- 0 (default value): characteristics of the SDUs unknown
- 1: characteristics of the SDUs correspond to a speech source

17.1.38 <Signaling_Indication>

Specifies signaling content of submitted SDUs for a PDP context. This parameter should be provided if the Traffic Class is set to interactive.

 On LEON-G1 / SARA-G3 / LISA-U1 series the <Signaling_Indication> parameter is not supported.

17.2 PPP LCP handshake behaviour

When a data call is initiated using the **+CGDATA** command (specifying "PPP" as L2 protocol) or with the **D*** command, the module switches to PPP mode just after the CONNECT intermediate result code. The first step of the PPP procedure is the LCP handshake, in this phase the behaviour of 2G products (i.e. LEON-G and SARA-G) differs from 3G products (LISA-U and SARA-U).

LEON-G SARA-G

By default the module starts PPP in silent mode, waiting the first LCP packet coming from the MT. If a valid LCP packet is received the module continues the LCP handshake by its side, otherwise it remains in wait state. If the module is in wait state, it is possible to make it switch back to the AT command mode toggling the DTR line.

It is possible to disable the PPP silent mode using the **+UDCONF=0** command. When the silent mode is disabled, the module will start sending the LCP configuration packets (up to 10 retries every 6 s) just after the CONNECT intermediate result code. If none valid LCP response packet is received from the MT, the module will act like in silent mode.

LISA-U SARA-U

The module starts in PPP silent mode (wait the first LCP packet): if the MT does not starts the LCP handshake in between 1 s, the module starts sending the LCP configuration packets by its side (up to 10 retries every 1 s). If none valid LCP response packet is received from the MT, the module drops the PDP context and displays the NO CARRIER final result code.

17.3 Define PDP context +CGDCONT

+CGDCONT						
Modules	LEON-G SARA-G LISA-U SARA-U					
Attributes	Syntax	PIN required	Settings saved	Can be aborted	Response time	Error reference
	partial	Yes	NVM	No	-	+CME Error

17.3.1 Description

Define the connection parameters for a PDP context, identified by the local context identification parameter <cid>. If the command is used only with parameter <cid>, the corresponding PDP context becomes undefined.

Each context is permanently stored so that its definition is persistent over power cycles.

 The response of the read command does not display the PAP and CHAP prefixes of the APN string.

 The command is used to set up the PDP context parameters for an external context, i.e. a data connection using the external IP stack (e.g. Windows dial up) and PPP link over the serial interface.

 If not specified the following values are assumed:

- <cid>: 1
- <PDP_type>: "IP"
- <APN>: "apn"
- <PDP_addr>: "0.0.0.0"
- <d_comp>: 0
- <h_comp>: 0

17.3.2 Syntax

Type	Syntax	Response	Example
Set	AT+CGDCONT=[<cid>[,<PDP_type>[,<APN>[,<PDP_addr>[,<d_comp>[,<h_comp>]]]]]	OK	AT+CGDCONT=1,"IP","APN_name", "1.2.3.4",0,0 OK
Read	AT+CGDCONT?	+CGDCONT: <cid>,<PDP_type>,<APN>,<PDP_addr>,<d_comp>,<h_comp> OK	+CGDCONT: 1,"IP","web.omnitel.it", "91.80.140.199",0,0 OK
Test	AT+CGDCONT=?	+CGDCONT: (range of <cid>s),<PDP_type>,,(list of supported <d_comp>s),(list of supported <h_comp>s) OK	+CGDCONT: (1-3),"IP",,(0-2),(0-4) OK

17.3.3 Defined values

Parameter	Type	Description
<cid>	Number	See Chapter 17.1.2
<PDP_type>	String	See Chapter 17.1.22
<APN>	String	See Chapter 17.1.1
<PDP_addr>	Number	See Chapter 17.1.21
<d_comp>	Number	See Chapter 17.1.3
<h_comp>	Number	See Chapter 17.1.11

17.3.4 Notes

Additional examples:

Command sent by DTE	DCE Response	Description
AT+CMEE=2	OK	Use verbose <err> values
AT+CGDCONT=?	+CGDCONT: (1-3),"IP",,(0),(0-1)	Test command

Command sent by DTE	DCE Response	Description
AT+CGDCONT=4,"IP","internet"	+CME ERROR: operation not allowed	Define out of range PDP contexts
AT+CGDCONT=2,"IP","internet"	OK	Define allowed PDP contexts
AT+CGDCONT=1,"IP","STATREAL"	OK	Define allowed PDP contexts
AT+CGDCONT=3,"IP","PAP:tim.ibox.it"	OK	Define allowed PDP contexts
AT+CGDCONT=253,"IP","internet"	+CME ERROR: operation not allowed	Define out of range PDP contexts
AT+CGDCONT?	+CGDCONT: 2,"IP","internet","0.0.0.0",0,0 +CGDCONT: 1,"IP","STATREAL","0.0.0.0",0,0 +CGDCONT: 3,"IP","tim.ibox.it","0.0.0.0",0,0 OK	Read command

LISA-U

- It is possible to omit the APN by leaving the context with <cid>=1 undefined and using it to dial up a PPP connection.

LEON-G / SARA-G

- The context's setting is not permanently stored in NVM.
- It is possible to omit the APN by specifying the <cid> and the <PDP_type> only.

LEON-G

- If only the parameter <cid> is set the corresponding PDP context is not undefined.

17.4 Packet switched data configuration +UPSD

+UPSD						
Modules	LEON-G SARA-G340 SARA-G350 LISA-U SARA-U					
Attributes	Syntax	PIN required	Settings saved	Can be aborted	Response time	Error reference
	partial	No	<i>NVM</i>	No	-	+CME Error

17.4.1 Description

Sets or reads the value of the specified parameter in a specific packet switched data (PSD) profile, or reads all the parameters of the given PSD profile, and lists them in separated lines.



The parameter values set with this command are volatile, but the whole profile can be stored in NVM with *AT+UPSDA* command.



In the read command, if only the first parameter is issued, the module returns all the parameters of the given PSD profile, and lists them in separated lines.



The command should be used to set up the PDP context parameters for an internal context, i.e. a data connection using the internal IP stack and related AT commands for sockets.

17.4.2 Syntax

Type	Syntax	Response	Example
Set	AT+UPSD=<profile_id>,<param_tag>,<param_val>	OK	AT+UPSD=0,1,"apn.provider.com" OK
Read	AT+UPSD=<profile_id>,<param_tag>	+UPSD: <profile_id>,<param_tag>,<param_val> OK	AT+UPSD=0,1 +UPSD: 0,1,"apn.provider.com" OK
	AT+UPSD=<profile_id>	+UPSD: <profile_id>,0,<param_val0> +UPSD: <profile_id>,1,<param_val1>... +UPSD: <profile_id>,x,<param_valx> OK	AT+UPSD=0 +UPSD: 0,0 +UPSD: 0,1,"apn.provider.com" +UPSD: 0,2,"username" +UPSD: 0,4,"0.0.0.0"



Type	Syntax	Response	Example
			...
			+UPSD: 0,19,0
			OK

17.4.3 Defined values

Parameter	Type	Description
<profile_id>	Number	PSD profile identifier, in range 0-6
<param_tag>	Number	<ul style="list-style-type: none"> • 0: Protocol type: <ul style="list-style-type: none"> o 0 (factory-programmed value): IPv4 o 1: IPv6; this value is currently reserved for future use (RFU) • 1: APN - <param_val> is defined by the text string of APN, e.g. "apn.provider.com"; the maximum length is 99. The factory-programmed value is an empty string. • 2: username - <param_val> is the user name text string for the authentication phase. The factory-programmed value is an empty string. • 3: password - <param_val> is the password text string for the authentication phase. Note: the AT+UPSD read command with <param_tag> = 3 is not allowed and the read all command does not display it • 4: DNS1 - <param_val> is the text string of the primary DNS address in dotted decimal notation form (i.e. four numbers in range 0-255 separated by periods, e.g. "xxx.yyy.zzz.www"). The factory-programmed value is "0.0.0.0". • 5: DNS2 - <param_val> is the text string of the secondary DNS address in dotted decimal notation form (i.e. four numbers in range 0-255 separated by periods, e.g. "xxx.yyy.zzz.www"). The factory-programmed value is "0.0.0.0". • 6: authentication - <param_val> selects the authentication type: <ul style="list-style-type: none"> o 0 (factory-programmed value): none o 1: PAP o 2: CHAP • 7: IP address - <param_val> is the text string of the static IP address given by the ISP in dotted decimal notation form (i.e. four numbers in range 0-255 separated by periods, e.g. "xxx.yyy.zzz.www"). The factory-programmed value is "0.0.0.0". Note: IP address set as "0.0.0.0" means dynamic IP address assigned during PDP context activation • 8: data compression - <param_val> selects the data compression type: <ul style="list-style-type: none"> o 0 (factory-programmed value): off o 1: predefined, i.e. V.42bis o 2: V.42bis • 9: header compression - <param_val> selects the header compression type: <ul style="list-style-type: none"> o 0 (factory-programmed value): off o 1: predefined, i.e. RFC1144 o 2: RFC1144 o 3: RFC2507 o 4: RFC3095 • 10: QoS precedence - <param_val> selects the precedence class: <ul style="list-style-type: none"> o 0 (factory-programmed value): subscribed o 1: high o 2: normal o 3: low • 11: QoS delay - <param_val> selects the delay class: <ul style="list-style-type: none"> o 0 (factory-programmed value): subscribed o 1: class 1 o 2: class 2 o 3: class 3 o 4: best effort • 12: QoS reliability - <param_val> selects the reliability class: <ul style="list-style-type: none"> o 0 (factory-programmed value): subscribed o 1: class 1 (Interpreted as class 2) o 2: class 2 (GTP Unack, LLC Ack and Protected, RLC Ack) o 3: class 3 (GTP Unack, LLC Unack and Protected, RLC Ack) o 4: class 4 (GTP Unack, LLC Unack and Protected, RLC Unack)



Parameter	Type	Description
		<ul style="list-style-type: none">o 5: class 5 (GTP Unack, LLC Unack and Unprotected, RLC Unack)o 6: class 6 (Interpreted as class 3)• 13: QoS peak rate - <param_val> selects the peak throughput in range 0-9. The factory-programmed value is 0.• 14: QoS mean rate - <param_val> selects the mean throughput in range 0-18, 31. The factory-programmed value is 0.• 15: minimum QoS precedence - <param_val> selects the acceptable value for the precedence class:<ul style="list-style-type: none">o 0 (factory-programmed value): subscribedo 1: higho 2: normalo 3: low• 16: minimum QoS delay - <param_val> selects the acceptable value for the delay class:<ul style="list-style-type: none">o 0 (factory-programmed value): subscribedo 1: class 1o 2: class 2o 3: class 3o 4: best effort• 17: minimum QoS reliability - <param_val> selects the minimum acceptable value for the reliability class:<ul style="list-style-type: none">o 0 (factory-programmed value): subscribedo 1: class 1 (Interpreted as class 2)o 2: class 2 (GTP Unack, LLC Ack and Protected, RLC Ack)o 3: class 3 (GTP Unack, LLC Unack and Protected, RLC Ack)o 4: class 4 (GTP Unack, LLC Unack and Protected, RLC Unack)o 5: class 5 (GTP Unack, LLC Unack and Unprotected, RLC Unack)o 6: class 6 (Interpreted as class 3)• 18: minimum QoS peak rate - <param_val> selects the acceptable value for the peak throughput in range 0-9. The factory-programmed value is 0.• 19: minimum QoS mean rate - <param_val> selects the acceptable value for the mean throughput in range 0-18, 31. The factory-programmed value is 0.• 20: 3G QoS delivery order - <param_val> selects the acceptable value for the delivery order:<ul style="list-style-type: none">o 0 (factory-programmed value): subscribedo 1: enableo 2: disable• 21: 3G QoS erroneous SDU delivery - <param_val> selects the acceptable value for the erroneous SDU delivery:<ul style="list-style-type: none">o 0 (factory-programmed value): subscribedo 1: no detectiono 2: enableo 3: disable• 22: 3G QoS extended guaranteed downlink bit rate - <param_val> is the value for the extended guaranteed downlink bit rate in kb/s. The factory-programmed value is 0.• 23: 3G QoS extended maximum downlink bit rate - <param_val> is the value for the extended maximum downlink bit rate in kb/s. The factory-programmed value is 0.• 24: 3G QoS guaranteed downlink bit rate - <param_val> is the value for the guaranteed downlink bit rate in kb/s. The factory-programmed value is 0.• 25: 3G QoS guaranteed uplink bit rate - <param_val> is the value for the guaranteed uplink bit rate in kb/s. The factory-programmed value is 0.• 26: 3G QoS maximum downlink bit rate - <param_val> is the value for the maximum downlink bit rate in kb/s. The factory-programmed value is 0.• 27: 3G QoS maximum uplink bit rate - <param_val> is the value for the maximum uplink bit rate in kb/s. The factory-programmed value is 0.• 28: 3G QoS maximum SDU size - <param_val> is the value for the maximum SDU size in octets. The factory-programmed value is 0.• 29: 3G QoS residual bit error rate - <param_val> selects the acceptable value for the residual bit error rate:<ul style="list-style-type: none">o 0 (factory-programmed value): subscribedo 1: 5E2o 2: 1E2



Parameter	Type	Description
		<ul style="list-style-type: none">o 3: 5E3o 4: 4E3o 5: 1E3o 6: 1E4o 7: 1E5o 8: 1E6o 9: 6E8
		<ul style="list-style-type: none">• 30: 3G QoS SDU error ratio - <param_val> selects the acceptable value for the SDU error ratio:<ul style="list-style-type: none">o 0 (factory-programmed value): subscribedo 1: 1E2o 2: 7E3o 3: 1E3o 4: 1E4o 5: 1E5o 6: 1E6o 7: 1E1
		<ul style="list-style-type: none">• 31: 3G QoS signalling indicator - <param_val> selects the acceptable value for the signalling indicator:<ul style="list-style-type: none">o 0 (factory-programmed value): subscribedo 1: signalling indicator 1
		<ul style="list-style-type: none">• 32: 3G QoS source statistics descriptor - <param_val> selects the acceptable value for the source statistics descriptor:<ul style="list-style-type: none">o 0 (factory-programmed value): subscribedo 1: source statistics descriptor 1
		<ul style="list-style-type: none">• 33: 3G QoS traffic class - <param_val> selects the acceptable value for the traffic class:<ul style="list-style-type: none">o 0 (factory-programmed value): subscribedo 1: conversationalo 2: streamingo 3: interactiveo 4: background
		<ul style="list-style-type: none">• 34: 3G QoS traffic priority - <param_val> selects the acceptable value for the traffic priority:<ul style="list-style-type: none">o 0 (factory-programmed value): subscribedo 1: priority 1o 2: priority 2o 3: priority 3
		<ul style="list-style-type: none">• 35: 3G QoS transfer delay - <param_val> is the value for the transfer delay in milliseconds. The factory-programmed value is 0.
		<ul style="list-style-type: none">• 36: 3G Minimum QoS delivery order - <param_val> selects the acceptable value for the delivery order:<ul style="list-style-type: none">o 0 (factory-programmed value): subscribedo 1: enableo 2: disable
		<ul style="list-style-type: none">• 37: 3G Minimum QoS erroneous SDU delivery - <param_val> selects the acceptable value for the erroneous SDU delivery:<ul style="list-style-type: none">o 0 (factory-programmed value): subscribedo 1: no detectiono 2: enableo 3: disable
		<ul style="list-style-type: none">• 38: 3G Minimum QoS extended guaranteed downlink bit rate - <param_val> is the value for the extended guaranteed downlink bit rate in kb/s. The factory-programmed value is 0.
		<ul style="list-style-type: none">• 39: 3G Minimum QoS extended maximum downlink bit rate - <param_val> is the value for the extended maximum downlink bit rate in kb/s. The factory-programmed value is 0.
		<ul style="list-style-type: none">• 40: 3G Minimum QoS guaranteed downlink bit rate - <param_val> is the value for the guaranteed downlink bit rate in kb/s. The factory-programmed value is 0.
		<ul style="list-style-type: none">• 41: 3G Minimum QoS guaranteed uplink bit rate - <param_val> is the value for the guaranteed uplink bit rate in kb/s. The factory-programmed value is 0.
		<ul style="list-style-type: none">• 42: 3G Minimum QoS maximum downlink bit rate - <param_val> is the value for the maximum downlink bit rate in kb/s. The factory-programmed value is 0.



Parameter	Type	Description
		<ul style="list-style-type: none">• 43: 3G Minimum QoS maximum uplink bit rate - <param_val> is the value for the maximum uplink bit rate in kb/s. The factory-programmed value is 0.• 44: 3G Minimum QoS maximum SDU size - <param_val> is the value for the maximum SDU size in octets. The factory-programmed value is 0.• 45: 3G Minimum QoS residual bit error rate - <param_val> selects the acceptable value for the residual bit error rate:<ul style="list-style-type: none">o 0 (factory-programmed value): subscribedo 1: 5E2o 2: 1E2o 3: 5E3o 4: 4E3o 5: 1E3o 6: 1E4o 7: 1E5o 8: 1E6o 9: 6E8• 46: 3G Minimum QoS SDU error ratio - <param_val> selects the acceptable value for the SDU error ratio:<ul style="list-style-type: none">o 0 (factory-programmed value): subscribedo 1: 1E2o 2: 7E3o 3: 1E3o 4: 1E4o 5: 1E5o 6: 1E6o 7: 1E1• 47: 3G Minimum QoS signalling indicator - <param_val> selects the acceptable value for the signalling indicator:<ul style="list-style-type: none">o 0 (factory-programmed value): subscribedo 1: signalling indicator 1• 48: 3G Minimum QoS source statistics descriptor - <param_val> selects the acceptable value for the source statistics descriptor:<ul style="list-style-type: none">o 0 (factory-programmed value): subscribedo 1: source statistics descriptor 1• 49: 3G Minimum QoS traffic class - <param_val> selects the acceptable value for the traffic class:<ul style="list-style-type: none">o 0 (factory-programmed value): subscribedo 1: conversationalo 2: streamingo 3: interactiveo 4: background• 50: 3G Minimum QoS traffic priority - <param_val> selects the acceptable value for the traffic priority:<ul style="list-style-type: none">o 0 (factory-programmed value): subscribedo 1: priority 1o 2: priority 2o 3: priority 3• 51: 3G Minimum QoS transfer delay - <param_val> is the value for the transfer delay in milliseconds. The factory-programmed value is 0.

17.4.4 Notes

- For the description of the QoS parameters, see 3GPP TS 02.60 and 3GPP TS 03.60 [10].
- The maximum length of <param_val> if <param_tag> is equal to 2 or 3 is 64.

LISA-U1

- If <param_tag> = 6, <param_val> can only assume the value 2 (CHAP).

LEON-G / SARA-G350 / SARA-G340

- The maximum length of <param_val> if <param_tag> is equal to 2 or 3 is 30.
- If <param_tag>=12 (or 17) and <param_val>=1 means GTP Ack, LLC Ack and Protected, RLC Ack.
- If <param_tag>=12 (or 17) <param_val>=6 is not supported.
- The values of <param_tag> greater than 19 are not supported.
- If <param_tag>=9, <param_val>=3 and 4 are not supported.

17.5 Packet switched data action +UPSDA

+UPSDA						
Modules	LEON-G SARA-G340 SARA-G350					
	LISA-U SARA-U					
Attributes	Syntax	PIN required	Settings saved	Can be aborted	Response time	Error reference
	partial	No	No	Yes	<i>Up to 3 min</i>	<i>+CME Error</i>

17.5.1 Description

Performs the requested action for the specified PSD profile.

The command can be aborted. When <action>=3 (activate) or <action>=4 (deactivate) is aborted, the +UUPSDDA URC is provided. The <result> parameter indicates the operation result. Until this operation is not completed, another set command cannot be issued.

The +UUPSDD URC is raised when the data connection related to the provided PSD profile is deactivated either explicitly by the network (e.g. due to prolonged idle time) or locally by the module after a failed PS registration procedure (e.g. due to roaming) or a user required detach (e.g. triggered by AT+COPS=2).

17.5.2 Syntax

Type	Syntax	Response	Example
Set	AT+UPSDA=<profile_id>,<action>	OK	AT+UPSDA=2,1 OK
URC		+UUPSDD: <profile_id>	
URC		+UUPSDDA: <result>	

17.5.3 Defined values

Parameter	Type	Description
<profile_id>	Number	PSD profile identifier, in range 0-6
<action>	Number	<ul style="list-style-type: none"> • 0: reset; it clears the specified profile resetting all the parameters to their factory-programmed values • 1: store; it saves all the parameters in NVM • 2: load; it reads all the parameters from NVM • 3: activate; it activates a PDP context with the specified profile, using the current parameters • 4: deactivate; it deactivates the PDP context associated with the specified profile
<result>	Number	<ul style="list-style-type: none"> • 0: action successful • Different values mean an unsuccessful action (the codes are listed in the Appendix A.7)

17.5.4 Notes

- Only one profile can be activated at the same time. The PDP context activation on more than one profile at the same time is not supported.
- The number of PDP contexts defined with AT+CGDCONT plus the number of contexts activated with +UPSDA cannot exceed three. Any further request to define a context with AT+CGDCONT or to activate a context with +UPSDA generates an error.
- In case of remote deactivation of the PDP context associated with a PSD profile, the URC is sent to the TE to inform the user, otherwise the user should deactivate the PDP context after usage.



- In case of PDP deactivation (triggered by either network or the user) all the sockets that have been created will automatically be closed.

LISA-U / SARA-U

- The command shall not be aborted before the expected maximum response time of 180 s. If aborted, the requested procedure (e.g. the PS data call activation or deactivation) will not be stopped, hence it will not be possible for the application processor to clearly understand when it is finished.

LISA-U

- If the <action>= 3 (Activate) the <cid> of the PDP context is set to 31.

LISA-U1 / LISA-U2x0-01S / LISA-U200-00S

- The command cannot be aborted.
- The +UUPSDA URC is not supported.

SARA-G350 / SARA-G340

- If the <action>= 3 (activate) the <cid> of the PDP context is set to 4.

LEON-G

- If the <action>= 3 (activate) the <cid> of the PDP context is set to 4.

LEON-G100-06S

- The command cannot be aborted.
- The +UUPSDA URC is not supported.
- In case of PDP deactivation (triggered by either network or the user), it is up to the user or the application to close all the sockets that have been created and are still open.

17.6 Packet switched network-assigned data +UPSND

+UPSND						
Modules	LEON-G SARA-G340 SARA-G350 LISA-U SARA-U					
Attributes	Syntax	PIN required	Settings saved	Can be aborted	Response time	Error reference
	partial	No	No	No	-	+CME Error

17.6.1 Description

Returns the current (dynamic) network-assigned or network-negotiated value of the specified parameter for the active PDP context associated with the specified PSD profile.

17.6.2 Syntax

Type	Syntax	Response	Example
Set	AT+UPSND=<profile_id>,<param_tag>	+UPSND: <profile_id>,<param_tag>,<dynamic_param_val> OK	AT+UPSND=2,0 +UPSND: 2,0,"151.9.78.170" OK

17.6.3 Defined values

Parameter	Type	Description
<profile_id>	Number	PSD profile identifier, in range 0-6
<param_tag>	Number	Index representing a network-assigned or network-negotiated parameter: <ul style="list-style-type: none"> • 0: IP address: dynamic IP address assigned during PDP context activation; • 1: DNS1: dynamic primary DNS address; • 2: DNS2: dynamic secondary DNS address; • 3: QoS precedence: network assigned precedence class of the QoS; • 4: QoS delay: network assigned delay class of the QoS; • 5: QoS reliability: network assigned reliability class of the QoS; • 6: QoS peak rate: network assigned peak rate value of the QoS;

Parameter	Type	Description
		<ul style="list-style-type: none"> 7: QoS mean rate: network assigned mean rate value of the QoS 8: PSD profile status: if the profile is active the return value is 1, 0 otherwise 9: 3G QoS delivery order 10: 3G QoS erroneous SDU delivery 11: 3G QoS extended guaranteed downlink bit rate 12: 3G QoS extended maximum downlink bit rate 13: 3G QoS guaranteed downlink bit rate 14: 3G QoS guaranteed uplink bit rate 15: 3G QoS maximum downlink bit rate 16: 3G QoS maximum uplink bit rate 17: 3G QoS maximum SDU size 18: 3G QoS residual bit error rate 19: 3G QoS SDU error ratio 20: 3G QoS signalling indicator 21: 3G QoS source statistics descriptor 22: 3G QoS traffic class 23: 3G QoS traffic priority 24: 3G QoS transfer delay
<dynamic_param_val>	String	Network-assigned or network-negotiated value of the parameter specified in <param_tag>

17.6.4 Notes

LEON-G / SARA-G350 / SARA-G340

- The values of <param_tag> greater than 8 are not supported.

17.7 Quality of service profile (requested) +CGQREQ

+CGQREQ						
Modules	LEON-G SARA-G LISA-U SARA-U					
Attributes	Syntax	PIN required	Settings saved	Can be aborted	Response time	Error reference
	full	Yes	No	No	-	+CME Error

17.7.1 Description

Allows the DTE to specify the QoS (Quality of Service) profile requested from the Network during the PDP context activation procedure. The set command specifies the QoS profile for the context identified by the <cid> parameter. When set command is used with only <cid> parameter, it sets all requested QoS parameters for the given profile to their default value 0 (subscribed QoS).



The command defines a PDP context having <PDP_type> set to "IP", <apn> set to "" and with the specified <cid>, if a PDP context with the specified <cid> was not already defined by +CGDCONT AT command.



If not specified the following values are assumed:

- <cid>: 1
- <precedence>: 0
- <delay>: 0
- <reliability>: 0
- <peak>: 0
- <mean>: 0

17.7.2 Syntax

Type	Syntax	Response	Example
Set	AT+CGQREQ=[<cid>[,<precedence>[,<delay>[,reliability>[,<peak>[,<mean>]]]]]]	OK	AT+CGQREQ=1,1,1,1,1,1 OK

Type	Syntax	Response	Example
Read	AT+CGQREQ?	+CGQREQ: <cid>,<precedence>,<delay>,<reliability>,<peak>,<mean>	+CGQREQ: 1,1,1,1,1,1 OK
Test	AT+CGQREQ=?	+CGQREQ: <PDP_type>,(list of supported <precedence>s),(list of supported <delay>s),(list of supported <reliability>s),(list of supported <peak>s),(list of supported <mean>s) [+CGQREQ: <PDP_type>,(list of supported <precedence>s),(list of supported <delay>s),(list of supported <reliability>s),(list of supported <peak>s),(list of supported <mean>s)] [...] OK	+CGQREQ: "IP",(0-3),(0-4),(0-5),(0-9),(0-18,31) OK

17.7.3 Defined values

Parameter	Type	Description
<cid>	Number	See Chapter 17.1.2
<precedence>	Number	See Chapter 17.1.23
<delay>	Number	See Chapter 17.1.4
<reliability>	Number	See Chapter 17.1.24
<peak>	Number	See Chapter 17.1.20
<mean>	Number	See Chapter 17.1.17

17.8 Quality of service profile (minimum acceptable) +CGQMIN

+CGQMIN						
Modules	LEON-G SARA-G LISA-U SARA-U					
Attributes	Syntax	PIN required	Settings saved	Can be aborted	Response time	Error reference
	full	Yes	No	No	-	+CME Error

17.8.1 Description

DTE specifies a minimum acceptable QoS (Quality of Service) profile which is checked by the MT against the negotiated QoS profile returned by the network during the PDP context activation procedure.

The set command specifies a QoS profile for the context identified by the <cid> parameter. The QoS profile consists in a set of parameters, each one is configurable. When set command is used with only <cid> parameter, the minimum acceptable QoS profile for the given context is undefined. In this case no check is made against the negotiated QoS profile during PDP context activation.



If not specified the following values are assumed:

- <cid>: 1
- <precedence>: 3
- <delay>: 4
- <reliability>: 5
- <peak>: 1
- <mean>: 1

17.8.2 Syntax

Type	Syntax	Response	Example
Set	AT+CGQMIN=[<cid>[,<precedence>[,<delay>[,<reliability>[,<peak>[,<mean>]]]]]]	OK	AT+CGQMIN=1,1,1,1,1,1 OK

Type	Syntax	Response	Example
Read	AT+CGQMIN?	+CGQMIN: <cid>,<precedence>,<delay>,<reliability>,<peak>,<mean>	+CGQMIN: 1,1,1,1,1,1 OK
Test	AT+CGQMIN=?	+CGQMIN: <PDP_type>,(list of supported <precedence>s),(list of supported <delay>s),(list of supported <reliability>s),(list of supported <peak>s),(list of supported <mean>s) [+CGQMIN: <PDP_type>,(list of supported <precedence>s),(list of supported <delay>s),(list of supported <reliability>s),(list of supported <peak>s),(list of supported <mean>s) [...]]	+CGQMIN: "IP",(0-3),(0-4),(0-5),(0-9),(0-18,31) OK

17.8.3 Defined values



Parameter	Type	Description
<cid>	Number	See Chapter 17.1.2
<precedence>	Number	See Chapter 17.1.23
<delay>	Number	See Chapter 17.1.4
<reliability>	Number	See Chapter 17.1.24
<peak>	Number	See Chapter 17.1.20
<mean>	Number	See Chapter 17.1.17

17.9 GPRS attach or detach +CGATT

+CGATT						
Modules	LEON-G SARA-G LISA-U SARA-U					
Attributes	Syntax	PIN required	Settings saved	Can be aborted	Response time	Error reference
	full	Yes	No	Yes	Up to 3 min	+CME Error

17.9.1 Description

Register (attach) the MT to, or deregister (detach) the MT from the GPRS service. After this command the MT remains in AT command mode. If the MT is already in the requested state (attached or detached), the command is ignored and OK result code is returned. If the requested state cannot be reached, an error result code is returned. The command can be aborted if a character is sent to the DCE during the command execution. Any active PDP context will be automatically deactivated when the GPRS registration state changes to detached.

-  If MT is configured in class "B" (see command [+CGCLASS](#)) and the GSM registration has not yet been performed, AT+CGATT=1 triggers both GSM and GPRS registration.
-  The deregistration action is carried out even if the command is aborted.
-  Unless the MS is detached from GPRS service due to a previously performed GPRS detach, the set command with <state>=1 triggers a user reselection. In this case a search for the HPLMN or a higher order PLMN is triggered (for more details see [Chapter 7.3](#) and 3GPP TS 23.122 [70]).

17.9.2 Syntax

Type	Syntax	Response	Example
Set	AT+CGATT=[<state>]	OK	AT+CGATT=1 OK
Read	AT+CGATT?	+CGATT: <state>	+CGATT: 1

Type	Syntax	Response	Example
Test	AT+CGATT=?	OK +CGATT: (list of supported <state>s) OK	OK +CGATT: (0-1) OK

17.9.3 Defined values

Parameter	Type	Description
<state>	Number	See Chapter 17.1.25

17.10 PDP context activate or deactivate +CGACT

+CGACT						
Modules	LEON-G SARA-G					
	LISA-U SARA-U					
Attributes	Syntax	PIN required	Settings saved	Can be aborted	Response time	Error reference
	full	Yes	No	Yes	Up to 40-150 s (see below)	+CME Error

17.10.1 Description

Activates or deactivates the specified PDP context. After the command the MT remains in AT command mode. If any context is already in the requested state, the state for the context remains unchanged. If the required action cannot succeed, an error result code is returned. If the MT is not GPRS attached when the activation of a PDP context is required, the MT first performs a GPRS attach and then attempts to activate the specified context.

The command can be aborted if a character is sent to the DCE during the command execution: in case a PDP context activation on a specific <cid> was requested, the PDP context deactivation is performed; if a multiple PDP context activation was requested, it is aborted after the pending PDP context activation has finished.



The deactivation action is carried out even if the command is aborted.



The maximum expected response time is different in case the activation or the deactivation of a PDP context is performed (150 s and 40 s respectively).

17.10.2 Syntax

Type	Syntax	Response	Example
Set	AT+CGACT=[<status>[,<cid>[,...]]]	OK	AT+CGACT=1,1 OK
Read	AT+CGACT?	[+CGACT: <cid>,<status> +CGACT: <cid>,<status> [...]] OK	+CGACT: 1,1 OK
Test	AT+CGACT=?	+CGACT: (list of supported <status>s) OK	+CGACT: (0-1) OK

17.10.3 Defined values

Parameter	Type	Description
<status>	Number	See Chapter 17.1.26
<cid>	Number	See Chapter 17.1.2

17.10.4 Notes

- If <cid> is not defined, the command activates or deactivates all the defined PDP contexts.
- The number of PDP contexts defined with *AT+CGDCONT* plus the number of contexts activated with *AT+UPSDA* should not exceed the maximum number of definable PDP contexts (e.g. 3 or 11); in that case



any further request to define a context with *AT+CGDCONT* or to activate a context with *AT+UPSDA* will generate an error result code.

- Do not issue this command to configure internal PDP contexts (see *+UCSD*, *+UCSDA* and *+UCSND* AT commands for establishing a CSD connection and *+UPSD*, *+UPSDA* and *+UPSND* AT commands for establishing a PSD connection).

Examples of usage of *+CGDCONT*, *+CGACT*, *+CGPADDR* command:

Command sent by DTE	DCE Response	Description
AT+CMEE=2	OK	Use verbose <err> values
AT+COPS=0	OK	
AT+COPS?	+COPS: 0,0,"vodafone IT"	
	OK	
AT+CGDCONT=1,"IP", "web.omnitel.it"	OK	Define several PDP contexts
AT+CGDCONT=3,"IP", "internet"	OK	
AT+CGDCONT=2,"IP", "mms.vodafone.it"	OK	
AT+CGDCONT?	+CGDCONT: 1,"IP", "web.omnitel.it", "0.0.0.0",0,0 +CGDCONT: 3,"IP", "internet", "0.0.0.0",0,0 +CGDCONT: 2,"IP", "mms.vodafone.it", "0.0.0.0",0,0	Read PDP contexts
	OK	
AT+CGACT=1,1	OK	Activate PDP context 1
AT+CGPADDR=1	+CGPADDR: 1, "91.80.104.82"	Show address of PDP context 1
	OK	
AT+CGPADDR=2	+CGPADDR: 2, "0.0.0.0"	Show address of PDP context 2
	OK	
AT+CGPADDR=3	+CGPADDR: 3, "0.0.0.0"	Show address of PDP context 3
	OK	
AT+CGDCONT?	+CGDCONT: 1,"IP", "web.omnitel.it", "91.80.104.82",0 ,0 +CGDCONT: 3,"IP", "internet", "0.0.0.0",0,0 +CGDCONT: 2,"IP", "mms.vodafone.it", "0.0.0.0",0,0	
	OK	
AT+CGACT=0,1	OK	Deactivate PDP context 1
AT+CGDCONT?	+CGDCONT: 1,"IP", "web.omnitel.it", "0.0.0.0",0,0 +CGDCONT: 3,"IP", "internet", "0.0.0.0",0,0 +CGDCONT: 2,"IP", "mms.vodafone.it", "0.0.0.0",0,0	
	OK	
AT+CGACT=1	OK	Activate all of defined PDP contexts
AT+CGDCONT?	+CGDCONT: 1,"IP", "web.omnitel.it", "91.80.101.207", 0,0 +CGDCONT: 3,"IP", "internet", "83.225.114.136",0,0 +CGDCONT: 2,"IP", "mms.vodafone.it", "10.159.135.60", 0,0	
	OK	
AT+CGPADDR=1	+CGPADDR: 1, "91.80.101.207"	Show address of PDP context 1
	OK	
AT+CGPADDR=2	+CGPADDR: 2, "10.159.135.60"	Show address of PDP context 2
	OK	
AT+CGACT=0	OK	Deactivate all of defined PDP contexts



Command sent by DTE	DCE Response	Description
AT+CGPADDR=2	+CGPADDR: 2, "0.0.0.0" OK	Show address of PDP context 2
AT+CGPADDR=3	+CGPADDR: 3, "0.0.0.0" OK	Show address of PDP context 3
AT+CGDCONT?	+CGDCONT: 1,"IP","web.omnitel.it","0.0.0.0",0,0 +CGDCONT: 3,"IP","internet","0.0.0.0",0,0 +CGDCONT: 2,"IP","mms.vodafone.it","0.0.0.0",0,0 OK	
AT+CGACT=1,2	OK	Activate PDP context 2
AT+CGDCONT?	+CGDCONT: 1,"IP","web.omnitel.it","0.0.0.0",0,0 +CGDCONT: 3,"IP","internet","0.0.0.0",0,0 +CGDCONT: 2,"IP","mms.vodafone.it","10.153.123.229",0,0 OK	
AT+CGACT=1,3	OK	Activate PDP context 3
AT+CGDCONT?	+CGDCONT: 1,"IP","web.omnitel.it","0.0.0.0",0,0 +CGDCONT: 3,"IP","internet","83.225.171.77",0,0 +CGDCONT: 2,"IP","mms.vodafone.it","10.153.123.229",0,0 OK	
AT+CGACT=1,1	OK	Activate PDP context 1
AT+CGDCONT?	+CGDCONT: 1,"IP","web.omnitel.it","91.80.175.163",0,0 +CGDCONT: 3,"IP","internet","83.225.171.77",0,0 +CGDCONT: 2,"IP","mms.vodafone.it","10.153.123.229",0,0 OK	
AT+CGACT=0	OK	Deactivate all of defined PDP contexts
AT+CGDCONT?	+CGDCONT: 1,"IP","web.omnitel.it","0.0.0.0",0,0 +CGDCONT: 3,"IP","internet","0.0.0.0",0,0 +CGDCONT: 2,"IP","mms.vodafone.it","0.0.0.0",0,0 OK	

SARA-G300 / SARA-G310

- As the module supports one active PDP context, if more than one PDP context is defined, a request to activate all defined PDP contexts with <status>=1 and omitted <cid> generates an error result code.

LEON-G100-06S

- The command cannot be aborted.

17.11 Manual response to a network request for PDP context activation +CGANS

+CGANS						
Modules	LISA-U200-62S					
Attributes	Syntax	PIN required	Settings saved	Can be aborted	Response time	Error reference
	full	Yes	No	No	Up to 150 s	+CME Error

17.11.1 Description

Requests the MT to respond to a network request for the packet domain PDP context activation which has been indicated to the TE by the RING or +CRING URC.



This command is not equivalent to issuing a +CGDATA or +CGACT command after having received a +CRING URC: +CGDATA or +CGACT would not command the MT to acknowledge the network request indicated by the +CRING URC but would trigger a new independent PDP context activation.

17.11.2 Syntax

Type	Syntax	Response	Example
Set	AT+CGANS=[<response>],[<L2P>],[<cid>]]	OK	AT+CGANS=1 OK
Test	AT+CGANS=?	+CGANS: (list of supported <response>s), (list of supported <L2P>s) OK	+CGANS: (0,1),("PPP","M-OPT-PPP","M-HEX","M-RAW_IP","M-PPP-RELAY") OK

17.11.3 Defined values

Parameter	Type	Description
<response>	Number	Response action. Allowed values: <ul style="list-style-type: none"> 0 (default value): reject the request 1: accept and request the PDP context activation
<L2P>	String	See Chapter 17.1.13
<cid>	Number	See Chapter 17.1.2

17.11.4 Notes

- Typically only AT+CGANS=0 or AT+CGANS=1 are needed: the MT will automatically handle the remaining parameters.
- If the <L2P> parameter value is unacceptable to the MT, the MT shall return an ERROR or +CME ERROR response. Otherwise, the MT issues the CONNECT IRC and enters V.250 online data state. If the <L2P> is omitted then the MT will default it to "PPP" if the <PDP_type>="IP" or to "M-PPP-RELAY" if the <PDP_type>="PPP".
- If no <cid> is given or if there is no matching context definition, the MT will attempt to activate the context using the values for <PDP_type> and <PDP_addr> provided by the network, together with any other relevant information known to the MT. If the activation is successful, data transfer may proceed.

17.12 Automatic Response to a Network Request for PDP Context Activation +CGAUTO

+CGAUTO						
Modules	LISA-U200-62S					
Attributes	Syntax	PIN required	Settings saved	Can be aborted	Response time	Error reference
	full	Yes	No	No	-	+CME Error

17.12.1 Description

Disables or enables an automatic positive or negative response (auto-answer) to the reception of a NW-initiated request PDP context activation message. It also provides the control over the use of the V.250 basic commands S0, A and H for the handling network requests for a PDP context activation. The setting does not affect the issuing of the RING or +CRING URCs.

17.12.2 Syntax

Type	Syntax	Response	Example
Set	AT+CGAUTO=[<action>]	OK	AT+CGAUTO=0 OK
Read	AT+CGAUTO?	+CGAUTO: <action> OK	+CGAUTO: 1 OK
Test	AT+CGAUTO=?	+CGAUTO: (list of supported <action>s) OK	+CGAUTO: (0-4) OK

17.12.3 Defined values

Parameter	Type	Description
<action>	Number	Auto-answer action. The allowed values are: <ul style="list-style-type: none"> • 0 (default value): turn off the automatic response for Packet Domain only • 1: turn on the automatic response for Packet Domain only • 2: modem compatibility mode, Packet Domain only • 3 (factory default value): modem compatibility mode, Packet Domain and circuit switched calls • 4: turn on the automatic negative response for Packet Domain only

17.12.4 Notes

- If <action>=0 the packet domain network requests are manually accepted or rejected by +CGANS commands.
- If <action>=1 the packet domain network requests are automatically accepted.
- If <action>=2 the automatic acceptance of the packet domain network requests is controlled by the S0 command. The manual control uses the A and H commands, respectively, to accept and reject the packet domain requests (+CGANS may also be used). The incoming circuit switched calls can be neither manually nor automatically answered.
- For <action>=3 automatic acceptance of both packet domain network requests and incoming circuit switched calls is controlled by the S0 command. The manual control uses the A and H commands, respectively, to accept and reject the packet domain requests (+CGANS may also be used).
- For <action>=4 the packet domain network requests are automatically rejected.

17.13 Enter data state +CGDATA

+CGDATA						
Modules	LEON-G SARA-G LISA-U SARA-U					
Attributes	Syntax	PIN required	Settings saved	Can be aborted	Response time	Error reference
	full	Yes	No	No	Up to 3 min (<1 s for prompt ">" when present)	+CME Error

17.13.1 Description

Causes the MT to set up a data communication channel between the DTE and the PDP network. For the u-blox specific L2 modes M-HEX and M-RAW_IP, this means performing a GPRS attach and one or more PDP context activations, if not already done.

If the parameters are accepted (and optionally the PDP context is successfully activated), the MT displays the intermediate result code CONNECT on the DTE and enters the online data mode, thus allowing data transfer. Other commands following +CGDATA in the command line will be processed. When the data transfer is completed, the MT re-enters into command mode and the final result code is displayed on DTE.

In case of error the final result code NO CARRIER or +CME ERROR: <error> is displayed.

 If not specified, value 1 is assumed for <cid>.

 The session is terminated sending ~+++ , which may cause the deactivation, if active, of the PDP context depending on DTR line status, i.e. on the AT&D setting (see [Chapter 14.3.4](#) and [Chapter 14.3.5](#)). When using M-HEX as L2 protocol and AT&D2 is used, the channel is switched back to command mode but the PDP context remains active.

 When using PPP as L2 protocol, no GPRS attach and no PDP context activation are performed until the PPP on the DTE side starts communication with the PPP on the MT side.

The M-HEX L2 protocol (AT+CGDATA="M-HEX",1) can be used as follows:

- Syntax: <int: counter> <int: length[1-1500]> <hex-sequence>[0-9a-fA-F]
- Syntax: cid=<int: cid>
- Syntax: +++<cr>

Examples:

1 200<CR> - send 1 packet with 200 0x2B (fill character)

5 5<CR> - send 5 packets with 5 0x2B (fill character)

1 5 31 32 33 34 35<CR> - send 1 packet with the given contents

1 5 1 2 3 4 05<CR> - send 1 packet with the given contents

1 10 31 Q<CR> - send 1 packet with 10 0x31

cid=2 - send packets on cid 2 (this requires two active PDP contexts and the M-HEX L2 protocol entered on <cid> = 1

+++ - leave the online mode

A packet is sent if one of the following conditions is met:

- the length field is terminated with <CR>
- the length value is equal to # characters of hex-sequence and it is terminated with <CR>
- the input is terminated with a character not equal to a hex digit and <CR>

 This syntax of the command is mainly used to perform regulatory and conformance testing.

17.13.2 Syntax

Type	Syntax	Response	Example
Set	AT+CGDATA=[<L2P>[,<cid>]]	CONNECT (data transfer starts)	AT+CGDATA="PPP",1 CONNECT
Test	AT+CGDATA=?	+CGDATA: (list of supported <L2P>s) OK	+CGDATA: ("PPP","M-HEX","M-RAW_IP","M-OPT-PPP") OK

17.13.3 Defined values

Parameter	Type	Description
<L2P>	String	See Chapter 17.1.13
<cid>	Number	See Chapter 17.1.2

17.13.4 Notes

- The cid command, which has not to be confused with the <cid> parameter, can be used while in data mode for switching to a PDP context already active.
- The cid command accepts as parameter a <cid> value corresponding to a PDP context already active and has to be typed in lower-case.
- Usage of +CGDATA command:

Command sent by DTE	DCE Response	Description
AT+CMEE=2	OK	Use verbose <err> values
AT&D0	OK	
AT+CGDCONT=1,"IP","web.omnitel.it"	OK	Define two PDP contexts
AT+CGDCONT=2,"IP","internet"	OK	
AT+CGACT=1,2	OK	Activate PDP context 2
AT+CGDATA="M-HEX",1	CONNECT	Activate PDP context 1 and establish mandatory L2 protocol between DTE and MT
1 100	DATA OK	Send one packet of 100 bytes
cid=2	OK	Switch to the already activated context 2
~+++	NO CARRIER	Only the first activated context or the last used is closed

LEON-G / SARA-G

- The module does not start in PPP silent mode.

17.14 Enter IP state/GPRS IP dial D*

D*						
Modules	LEON-G SARA-G					
	LISA-U					
Attributes	Syntax	PIN required	Settings saved	Can be aborted	Response time	Error reference
	full	Yes	No	No	<i>Up to 3 min</i>	<i>+CME Error</i>

17.14.1 Description

The V.24ter dial command "D", similar to the command with the syntax AT+CGDATA="PPP",<cid>, causes the MT to perform the necessary actions to establish communication between the DTE and the external PDP network. This includes performing a GPRS attach and, if the PPP server on the DTE side starts communication, PDP context activation on the specified PDP context identifier (if not already requested via +CGATT and +CGACT commands).

If the command is accepted and the preliminary GPRS procedures have succeeded, CONNECT is returned, the MT enters the V.25ter online data state and the PPP L2 protocol between the MT and the DTE is started.

User requested returning back to command line mode is possible by entering "+++" or "~+++" (see [Chapter 14.3.4](#)).

17.14.2 Syntax

Type	Syntax	Response	Example
Set	ATD[<dialing_type_char>]*<dialing_number>[*[<address>][*[<L2P>][*[<cid>]]]]#	CONNECT (data transfer starts)	ATD*99**1# CONNECT

17.14.3 Defined values

Parameter	Type	Description
<dialing_type_char>	String	Optional (legacy) T or P character indicating the tone dialing or pulse dialing respectively
<dialing_number>	Number	List all the supported values
<address>	-	ignored
<L2P>	String	See Chapter 17.1.13
<cid>	Number	See Chapter 17.1.2

17.14.4 Notes

- The context identifier <cid> maps to 1 if not specified.
- The GPRS dial command maps to AT+CGDATA="PPP",<cid>.

17.15 Show PDP address +CGPADDR

+CGPADDR						
Modules	LEON-G SARA-G LISA-U SARA-U					
Attributes	Syntax	PIN required	Settings saved	Can be aborted	Response time	Error reference
	full	Yes	No	No	-	+CME Error

17.15.1 Description

Returns a list of PDP addresses for the specified context identifiers. Only defined PDP contexts are displayed.

17.15.2 Syntax

Type	Syntax	Response	Example
Set	AT+CGPADDR=[<cid>,<cid> [...]]	+CGPADDR: <cid>,<PDP_addr> OK	AT+CGPADDR=1 +CGPADDR: 1,"1.2.3.4" OK
Test	AT+CGPADDR=?	+CGPADDR: [(list of defined <cid>s)] OK	+CGPADDR: 1,3 OK

17.15.3 Defined values

Parameter	Type	Description
<cid>	Number	See Chapter 17.1.2

17.16 GPRS MS class configuration +CGCLASS

+CGCLASS						
Modules	LEON-G SARA-G LISA-U SARA-U					
Attributes	Syntax	PIN required	Settings saved	Can be aborted	Response time	Error reference
	full	Yes	No	No	Up to 3 min	+CME Error

17.16.1 Description

Forces the detach/attach to the disabled/enabled service.

The read command gives the current class which does not depend on user settings but on the current registration state (e.g. on a CS cell only, class CC is returned).

The dial-up connection is not allowed if the module class was set to CC by means of this command.

If the module class was not forced to CC by the user, the dial up connection is allowed even if the module is not registered for PS services (e.g. *AT+CGATT=0* was entered), as it will trigger a PS registration beforehand.

17.16.2 Syntax

Type	Syntax	Response	Example
Set	AT+CGCLASS=[<class>]	OK	AT+CGCLASS="B" OK
Read	AT+CGCLASS?	+CGCLASS: <class> OK	+CGCLASS: "B" OK
Test	AT+CGCLASS=?	+CGCLASS: (list of supported <class>s) OK	+CGCLASS: ("A","B","CC","CG") OK

17.16.3 Defined values

Parameter	Type	Description
<class>	String	GPRS mobile class <ul style="list-style-type: none"> "A" (default value in Iu mode): class-A mode of operation (A/Gb mode), or CS/PS mode of operation (Iu mode) (highest mode of operation) "B" (default value in A/Gb mode): class B mode of operation (the MT can operate in both circuit-switched and packet-switched services but not simultaneously) "CC": class CC mode of operation (the MT can operate only in circuit-switched service) "CG": class CG mode of operation (the MT can operate only in packet-switched service)

17.16.4 Notes

- <class>="A" is only supported when in Iu mode.
- When in Iu mode (i.e. UMTS RAT), class A and class B have equivalent meanings (both CS and PS services supported). When in A/Gb mode (i.e. GSM RAT), class-A mode operation is not supported.

LEON-G / SARA-G

- To change the module class it is needed to deregister it from network, change the class type and again register the module on the network.
- <class>="A" is not supported.

17.17 GPRS MS class configuration at start up +UCGCLASS

+UCGCLASS						
Modules	LISA-U SARA-U					
Attributes	Syntax	PIN required	Settings saved	Can be aborted	Response time	Error reference
	partial	No	<i>NVM</i>	No	-	+CME Error

17.17.1 Description

Sets the startup class. If the class is set to CS only, before activating a PDP context it is necessary to trigger a PS attach via **+CGATT=1** or to change the class to B.

The current MS class will be stored in NVM and used at the next module power on.



u-blox cellular modules are certified according to all the capabilities and options stated in the Protocol Implementation Conformance Statement document (PICS) of the module. The PICS, according to 3GPP TS 51.010-2 [83] and 3GPP TS 34.121-2 [84], is a statement of the implemented and supported capabilities and options of a device. If the user changes the command settings during the certification process, the PICS of the application device integrating a u-blox cellular module must be changed accordingly.

17.17.2 Syntax

Type	Syntax	Response	Example
Set	AT+UCGCLASS=<class>	OK	AT+UCGCLASS="CC" OK
Read	AT+UCGCLASS?	+UCGCLASS: <class> OK	+UCGCLASS: "B" OK
Test	AT+UCGCLASS=?	+UCGCLASS: (list of supported <class>s) OK	+UCGCLASS: ("B","CC") OK

17.17.3 Defined values

Parameter	Type	Description
<class>	String	<ul style="list-style-type: none"> "B" (factory-programmed value): MS class B (the MT supports both circuit-switched and packet-switched services) "CC": MS class C (the MT supports only circuit switched services)

17.17.4 Notes

- If "CC" is selected, the network selection (**+COPS** AT command) triggers a registration only for CS services.
- If "CC" is selected, **+CGATT=1** forces the registration for PS services (i.e. +UCGCLASS' setting is ignored)

17.18 Device class setting +UCLASS

+UCLASS						
Modules	LEON-G SARA-G					
	LISA-U SARA-U					
Attributes	Syntax	PIN required	Settings saved	Can be aborted	Response time	Error reference
	partial	No	<i>NVM</i>	No	-	-

17.18.1 Description

Changes the module's multislot classes. The new configuration cannot be set if the module is registered on the network for the GPRS service: in this case, before changing the multislot class, the user must first trigger a GPRS detach (e.g. via **+COPS=2** or **+CGATT=0**) otherwise an error is reported; the new multislot class is used starting from the successive GPRS attach. The new multislot classes are also stored to NVM and used at next power on.



☞ u-blox cellular modules are certified according to all the capabilities and options stated in the Protocol Implementation Conformance Statement document (PICS) of the module. The PICS, according to 3GPP TS 51.010-2 [83] and 3GPP TS 34.121-2 [84], is a statement of the implemented and supported capabilities and options of a device. If the user changes the command settings during the certification process, the PICS of the application device integrating a u-blox cellular module must be changed accordingly.

☞ If <ms_class_GPRS>=0 the default values are set for all the parameters, regardless of the settings of the other parameter.

17.18.2 Syntax

Type	Syntax	Response	Example
Set	AT+UCLASS=<ms_class_GPRS>[,<ms_class_EGPRS>[,<ms_class_DTM_GPRS>[,<ms_class_DTM_EGPRS>]]]	OK	AT+UCLASS=10 OK
Read	AT+UCLASS?	+UCLASS: <ms_class_GPRS>[,<ms_class_EGPRS>[,<ms_class_DTM_GPRS>[,<ms_class_DTM_EGPRS>]]] OK	+UCLASS: 12,12,11,11 OK
Test	AT+UCLASS=?	+UCLASS: (list of supported <ms_class_GPRS> values)[,(list of supported <ms_class_EGPRS> values)[,(list of supported <ms_class_DTM_GPRS> values)[,(list of supported <ms_class_DTM_EGPRS> values)]]] OK	+UCLASS: (0-12),(0-12),(0-11),(0-11) OK

17.18.3 Defined values

Parameter	Type	Description
<ms_class_GPRS>	Number	GPRS multislot class defined according to 3GPP TS 05.02 [42]. Range from 0 to 12. Factory-programmed value is 12.
<ms_class_EGPRS>	Number	EGPRS multislot class defined according to 3GPP TS 05.02 [42]. Range from 0 to 12. Factory-programmed value is 12. Default value is the value set in <ms_class_GPRS>.
<ms_class_DTM_GPRS>	Number	DTM GPRS multislot class defined according to 3GPP TS 05.02 [42]. Range from 0 to 11. Factory-programmed value is 11. Default value is the value set in <ms_class_GPRS>.
<ms_class_DTM_EGPRS>	Number	DTM EGPRS multislot class defined according to 3GPP TS 05.02 [42]. Range from 0 to 11. Factory-programmed value is 11. Default value is the value set in <ms_class_GPRS>.

17.18.4 Notes

- In the set command <ms_class_GPRS>=0 is used to set the maximum supported values.
- The GPRS, EGPRS, DTM GPRS and DTM EGPRS multislot classes cannot be independently chosen (some configurations are not valid and an error is reported: "+CME ERROR: operation not supported" if +CMEE is set to 2). See the following tables:

Type	Valid values	Maximum value	Default value
E/GPRS	(1-12)	12	12
DTM E/GPRS	5, 9,11	11	11

Table 10: Multislot classes: valid, maximum and default values for each type

GPRS Multislot class	EGPRS Multislot class valid values
(1-12)	(1-12)
30	30, 32, 33
31	31
32	30, 32, 33

GPRS Multislot class	EGPRS Multislot class valid values
33	30, 32, 33

Table 11: EGPRS multislot classes valid values relative to the selected GPRS multislot class

DTMEGPRS/GPRS Multislot class	EGPRS/GPRS Multislot class valid values
5	(1-12)
9	(1-12)
11	(1-12)

Table 12: EGPRS/GPRS multislot classes valid values relative to the selected DTMEGPRS/GPRS multislot class

LISA-U1

- These series require the <ms_class_EGPRS> parameter in the set command.
- <ms_class_DTM_GPRS> and <ms_class_DTM_EGPRS> are not supported.
- if <ms_class_GPRS>=0 the default values are not set for all the parameters.

LISA-U200-00S

- The range of <ms_class_GPRS> parameter goes from 0 to 33, the maximum value is 33.
- The range of <ms_class_EGPRS> parameter goes from 0 to 33, the maximum value is 33.
- if <ms_class_GPRS>=0 the maximum supported values are set for all parameters, regardless of the second parameter's settings.
- if <ms_class_GPRS>=0 the default values are not set for all the parameters.
- <ms_class_DTM_GPRS> and <ms_class_DTM_EGPRS> are not supported.

LEON-G / SARA-G

- The range of <ms_class_GPRS> parameter goes from 0 to 10. The factory-programmed value is 10.
- <ms_class_GPRS>=7 is not allowed.
- <ms_class_EGPRS> is not supported.
- <ms_class_DTM_GPRS> and <ms_class_DTM_EGPRS> are not supported.
- if <ms_class_GPRS>=0 the default values are not set for all the parameters.

17.19 GPRS event reporting+CGEREP

+CGEREP						
Modules	LEON-G SARA-G					
	LISA-U SARA-U					
Attributes	Syntax	PIN required	Settings saved	Can be aborted	Response time	Error reference
	full	Yes	No	No	-	+CME Error

17.19.1 Description

Enables or disables sending of URCS from MT to the DTE, in case of certain events occurring during GPRS signalling between the MT and the network.

17.19.2 Syntax

Type	Syntax	Response	Example
Set	AT+CGEREP=[<mode>[,<bfr>]]	OK	AT+CGEREP=1,1 OK
Read	AT+CGEREP?	+CGEREP: <mode>,<bfr> OK	+CGEREP: 0,0 OK
Test	AT+CGEREP=?	+CGEREP: (list of supported <mode>s), (list of supported <bfr>s) OK	+CGEREP: (0-2),(0-1) OK



Type	Syntax	Response	Example
URC		+CGEV: NW DEACT <PDP_type>,<PDP_addr>,[<cid>] +CGEV: ME DEACT <PDP_type>,<PDP_addr>,[<cid>] +CGEV: NW DETACH +CGEV: ME DETACH +CGEV: NW CLASS <class> +CGEV: ME CLASS <class>	+CGEV: NW CLASS CC

17.19.3 Defined values

Parameter	Type	Description
<mode>	Number	Controls the processing of URCs specified within this command <ul style="list-style-type: none"> 0: buffer URCs in the MT; if buffer full the oldest ones will be discarded 1: discard URCs when V.24 link is reserved (online); otherwise forward them directly to the DTE 2: buffer URCs in the MT when link reserved (online) and flush them to the DTE when the link becomes available; otherwise forward them directly to the DTE
<bfr>	Number	Controls the effect on buffered codes when <mode> 1 or 2 is entered <ul style="list-style-type: none"> 0: MT buffer of URCs defined within this command is cleared when <mode> 1 or 2 is entered 1: MT buffer of URCs defined within this command is flushed to the DTE when <mode> 1 or 2 is entered (OK is given before flushing the codes)
<PDP_type>	Number	See Chapter 17.1.22
<PDP_addr>	Number	See Chapter 17.1.21
<cid>	Number	See Chapter 17.1.2
<class>	String	GPRS mobile class <ul style="list-style-type: none"> "A": class-A mode of operation (A/Gb mode), or CS/PS mode of operation (Iu mode) (highest mode of operation) "B": class B (circuit-switched and packet-switched data alternatively supported) "CG": class C (one service only) in GPRS mode "CC": class C (one service only) in circuit-switched (GSM) mode

17.19.4 Notes

The various URCs have the following meaning:

- +CGEV: NW DEACT <PDP_type>,<PDP_addr>,[<cid>] means that the network has forced a context deactivation
- +CGEV: ME DEACT <PDP_type>,<PDP_addr>,[<cid>] means that the mobile station has forced a context deactivation
- +CGEV: NW DETACH means that the network has forced a GPRS detach
- +CGEV: ME DETACH means that the mobile station has forced a GPRS detach
- +CGEV: NW CLASS <class> means that the network has forced a change of MT class (e.g. due to service detach); the highest available class is reported
- +CGEV: ME CLASS <class> means that the mobile station has forced a change of MT class; the highest available class is reported

LEON-G / SARA-G

- <class>= "A" is not supported.

17.20 GPRS network registration status +CGREG

+CGREG						
Modules	LEON-G SARA-G LISA-U SARA-U					
Attributes	Syntax	PIN required	Settings saved	Can be aborted	Response time	Error reference
	partial	No	No	No	-	+CME Error

17.20.1 Description

Configures the read command response and the GPRS network registration status URC syntax:

- If <n>=1 the URC will be issued for any change in the GPRS network registration status
- If <n>=2 the URC will be issued for any change in the network cell and in the GPRS network registration status



When <n>=2, in UMTS RAT, unsolicited location information can be received if the network sends the UTRAN INFORMATION MOBILITY message during dedicated connections. In contrast, in GSM RAT no unsolicited location information is received during a CS connection.

17.20.2 Syntax

Type	Syntax	Response	Example
Set	AT+CGREG=[<n>]	OK	AT+CGREG=1 OK
Read	AT+CGREG?	If <n>=0 or 1: +CGREG: <n>,<stat> OK	+CGREG: 0,4 OK
		If <n>=2: +CGREG: <n>,<stat>[,<lac>,<ci>[,<AcT>,<rac>]] OK	+CGREG: 2,1,"61EF","7D58A3",2,"14" OK
Test	AT+CGREG=?	+CGREG: (list of supported <n>s) OK	+CGREG: (0-2) OK
URC		If <n>=1: +CGREG: <stat>	+CGREG: 1
		If <n>=2: +CGREG: <stat>[,<lac>,<ci>[,<AcT>,<rac>]]	+CGREG: 1,"4E54","44A5"

17.20.3 Defined values

Parameter	Type	Description
<n>	Number	<ul style="list-style-type: none"> • 0 (default and factory-programmed value): network registration URC disabled • 1: network registration URC +CGREG: <stat> enabled • 2: network registration information URC +CGREG: <stat>[,<lac>,<ci>[,<AcT>,<rac>]] enabled
<stat>	Number	<ul style="list-style-type: none"> • 0: not registered, MT is not currently searching an operator to register to • 1: registered, home network • 2: not registered, but MT is currently searching a new operator to register to • 3: registration denied • 4: unknown • 5: registered, roaming
<lac>	String	Two bytes location area in hexadecimal format; it is optionally provided in the URC and in the response to the read command if <n>=2. The value FFFF means that the current <lac> value is invalid.
<ci>	String	From 2 to 4 bytes cell ID in hexadecimal format; it is optionally provided in the URC and in the response to the read command if <n>=2. The value FFFFFFFF means that the current <ci> value is invalid.

Parameter	Type	Description
<AcT>	Number	Indicates the radio access technology <ul style="list-style-type: none"> • 0: GSM • 1: GSM COMPACT • 2: UTRAN • 3: GSM with EDGE availability • 4: UTRAN with HSDPA availability • 5: UTRAN with HSUPA availability • 6: UTRAN with HSDPA and HSUPA availability • 7: Reserved • 255: the current <AcT> value is invalid
<rac>	String	One byte routing area in hexadecimal format

17.20.4 Notes

LISA-U1

- <AcT> and <rac> parameters are not supported.

LEON-G / SARA-G

- If GPRS is enabled and +CREG and +CGREG URCS are both enabled too, once the module is registered and attached then the two URCS are sent out quite at the same time.
- <AcT> and <rac> parameters are not supported.

17.21 Extended Packet Switched network registration status +UREG

+UREG						
Modules	LISA-U SARA-U					
Attributes	Syntax	PIN required	Settings saved	Can be aborted	Response time	Error reference
	partial	No	No	No	No	-

17.21.1 Description

Reports the network or the device PS (Packet Switched) radio capabilities.

When the device is not in connected mode, +UREG reports the network PS (Packet Switched) radio capabilities of the PLMN where the device is attached to.

When the device is in connected mode, +UREG reports the PS radio capabilities the device has been configured.

The set command allows to enable / disable the URC +UREG, generated whenever it is enabled and the capabilities change.

The read command can be used to query the current PS radio capabilities.

17.21.2 Syntax

Type	Syntax	Response	Example
Set	AT+UREG=<n>	OK	AT+UREG=1 OK
Read	AT+UREG?	+UREG: <n>,<state> OK	
Test	AT+UREG=?	+UREG: (list of supported <n>'s) OK	
URC		+UREG: <state>	

17.21.3 Defined values

Parameter	Type	Description
<n>	Number	<ul style="list-style-type: none"> 0: disable network registration attach status URC 1: enable network registration attach status URC +UREG
<state>	Number	<ul style="list-style-type: none"> 0: not registered for PS service 1: registered for PS service, RAT=2G, GPRS available 2: registered for PS service, RAT=2G, EDGE available 3: registered for PS service, RAT=3G, WCDMA available 4: registered for PS service, RAT=3G, HSDPA available 5: registered for PS service, RAT=3G, HSUPA available 6: registered for PS service, RAT=3G, HSDPA and HSUPA available 7: reserved 8: registered for PS service, RAT=2G, GPRS available, DTM available 9: registered for PS service, RAT=2G, EDGE available, DTM available

17.21.4 Notes

LISA-U1 / LISA-U200-00S

- <state>= 8 and 9 are not supported.

17.22 Select service for MO SMS messages +CGSMS

+CGSMS						
Modules	LEON-G SARA-G					
	LISA-U SARA-U					
Attributes	Syntax	PIN required	Settings saved	Can be aborted	Response time	Error reference
	full	No	NVM	No	-	+CME Error

17.22.1 Description

Specifies the service or service preference that the MT will use to send MO SMS messages.

17.22.2 Syntax

Type	Syntax	Response	Example
Set	AT+CGSMS=[<service>]	OK	AT+CGSMS=1 OK
Read	AT+CGSMS?	+CGSMS: <service> OK	+CGSMS: 1 OK
Test	AT+CGSMS=?	+CGSMS: (list of currently available <service>s) OK	+CGSMS: (0-3) OK

17.22.3 Defined values

Parameter	Type	Description
<service>	Number	service or service preference to be used <ul style="list-style-type: none"> 0: PSD 1 (factory default value): CSD 2: PSD preferred (use CSD if PSD is not available) 3: CSD preferred (use PSD if CSD is not available)

17.23 Manual deactivation of a PDP context H

H						
Modules	LEON-G SARA-G LISA-U SARA-U					
Attributes	Syntax	PIN required	Settings saved	Can be aborted	Response time	Error reference
	full	No	No	No	< 20s	-

17.23.1 Description

This command H (On-hook) deactivates a pending PDP context with PPP L2 protocol in online command mode. The MT responds with OK. See [Chapter 6.7](#) for a detailed description.



In GPRS online command mode, entered by typing the escape sequence "+++" or "~+++" (see [Chapter 14.3.4](#)), the ATH command is needed to terminate the connection. Alternatively, in data transfer mode, DTE originated DTR toggling or PPP disconnection may be used.

17.23.2 Syntax

Type	Syntax	Response	Example
Action	ATH	OK	

17.24 PDP Context Modify +CGCMOD

+CGCMOD						
Modules	LISA-U SARA-U					
Attributes	Syntax	PIN required	Settings saved	Can be aborted	Response time	Error reference
	partial	Yes	No	No	Up to 40 s	+CME Error

17.24.1 Description

This execution command is used to modify the specified PDP context(s) with respect to QoS profiles and TFT's. After the command is complete, the MT returns to the V.25 online data state. If the requested modification for any specified context cannot be achieved, an error response is returned. If no <cid>s are specified, the activation form of the command modifies all active contexts.

17.24.2 Syntax

Type	Syntax	Response	Example
Set	AT+CGCMOD=[<cid>[,<cid>[,...]]]	OK	AT+CGCMOD=1 OK
Test	AT+CGCMOD=?	+CGCMOD: (list of <cid>s with active contexts) OK	

17.24.3 Defined values

Parameter	Type	Description
<cid>	Number	See Chapter 17.1.2

Type	Syntax	Response	Example
		<SDU_error_ratio>s),(list of supported <Residual_bit_error_ratio>s),(list of supported <Delivery_of_erroneous_SDUs>s),(list of supported <Transfer_delay>s),(list of supported <Traffic_handling_priority>s) [+CGEQREQ: <PDP_type>,(list of supported <Traffic_class>s),(list of supported <Maximum_bitrate_UL>s),(list of supported <Maximum_bitrate_DL>s),(list of supported <Guaranteed_bitrate_UL>s),(list of supported <Guaranteed_bitrate_DL>s),(list of supported <Delivery_order>s),(list of supported <Maximum_SDU_size>s),(list of supported <SDU_error_ratio>s),(list of supported <Residual_bit_error_ratio>s),(list of supported <Delivery_of_erroneous_SDUs>s),(list of supported <Transfer_delay>s),(list of supported <Traffic_handling_priority>s),(list of supported <Source_statistics_descriptor>s),(list of supported <Signalling_indication>s) [...]] OK	-16000 in 100 kbps steps),(0-1),(10-1500,1502,1510,1520),("1E6","1E5","1E4","1E3","7E3","1E2","1E1"),("6E8","1E6","1E5","1E4","5E3","4E3","1E3","5E2","1E2"),(0-2),(10-150 in 10 ms steps, 200-950 in 50 ms steps, 1000-4000 in 50 ms steps),(0-3),(0-1),(0-1) OK

17.25.3 Defined values

Parameter	Type	Description
<cid>	Number	See Chapter 17.1.2
<Traffic_class>	Number	See Chapter 17.1.27
<Maximum_bitrate_UL>	Number	See Chapter 17.1.15
<Maximum_bitrate_DL>	Number	See Chapter 17.1.14
<Guaranteed_bitrate_UL>	Number	See Chapter 17.1.10
<Guaranteed_bitrate_DL>	Number	See Chapter 17.1.9
<Delivery_order>	Number	See Chapter 17.1.6
<Maximum_SDU_size>	Number	See Chapter 17.1.16
<SDU_error_ratio>	String	See Chapter 17.1.28
<Residual_bit_error_ratio>	String	See Chapter 17.1.29
<Delivery_of_erroneous_SDUs>	Number	See Chapter 17.1.5
<Transfer_delay>	Number	See Chapter 17.1.30
<Traffic_handling_priority>	Number	See Chapter 17.1.31
<Source_statistics_descriptor>	Number	See Chapter 17.1.37
<Signalling_indication>	Number	See Chapter 17.1.38

17.25.4 Notes

- If <Maximum_bitrate_UL>, <Maximum bitrate DL>, <Guaranteed_bitrate_UL>, <Guaranteed_bitrate_DL>, <Maximum_SDU_size> and <Transfer_delay> parameters are set outside the allowed range, an error message will be provided. If the value is selected within the allowed range, it is rounded to the closest allowed value according to the specified steps.
- If <Traffic_class>=0 (conversational) or <Traffic_class>=1 (streaming), <Maximum_bitrate_UL>, <Maximum_bitrate_DL>, <Guaranteed_bitrate_UL> and <Guaranteed_bitrate_DL> must be provided.
- If <Traffic_class>=0 (conversational) or <Traffic_class>=1 (streaming), <Source_statistics_descriptor> must be provided.
- If <Traffic_class>=2 (interactive), <Signalling_indication> must be provided.

Type	Syntax	Response	Example
		supported <Maximum_bitrate_UL>s), (list of supported <Maximum_bitrate_DL>s), (list of supported <Guaranteed_bitrate_UL>s), (list of supported <Guaranteed_bitrate_DL>s), (list of supported <Delivery_order>s), (list of supported <Maximum_SDU_size>s), (list of supported <SDU_error_ratio>s), (list of supported <Residual_bit_error_ratio>s), (list of supported <Delivery_of_erroneous_SDUs>s), (list of supported <Transfer_delay>s), (list of supported <Traffic_handling_priority>s) [+CGEQMIN: <PDP_type>,(list of supported <Traffic_class>s), (list of supported <Maximum_bitrate_UL>s), (list of supported <Maximum_bitrate_DL>s), (list of supported <Guaranteed_bitrate_UL>s), (list of supported <Guaranteed_bitrate_DL>s), (list of supported <Delivery_order>s), (list of supported <Maximum_SDU_size>s), (list of supported <SDU_error_ratio>s), (list of supported <Residual_bit_error_ratio>s), (list of supported <Delivery_of_erroneous_SDUs>s), (list of supported <Transfer_delay>s), (list of supported <Traffic_handling_priority>s), (list of supported <Source_statistics_descriptor>s), (list of supported <Signalling_indication>s) [...]] OK	in 64 kbps steps),(1-63 in 1 kbps steps, 64-568 in 8 kbps steps, 576-8640 in 64 kbps steps, 8700-16000 in 100 kbps steps),(1-63 in 1 kbps steps, 64-568 in 8 kbps steps, 576-8640 in 64 kbps steps), (1-63 in 1 kbps steps, 64-568 in 8 kbps steps, 576-8640 in 64 kbps steps, 8700 -16000 in 100 kbps steps),(0-1),(10-1500 ,1502,1510,1520),("1E6","1E5","1E4", "1E3","7E3","1E2","1E1"),("6E8", "1E6","1E5","1E4","5E3","4E3", "1E3","5E2","1E2"),(0-2),(10-150 in 10 ms steps, 200-950 in 50 ms steps, 1000 -4000 in 50 ms steps),(0-3),(0-1),(0-1) OK

17.26.3 Defined values

Parameter	Type	Description
<cid>	Number	See Chapter 17.1.2
<Traffic_class>	Number	See Chapter 17.1.27
<Maximum_bitrate_UL>	Number	See Chapter 17.1.15
<Maximum_bitrate_DL>	Number	See Chapter 17.1.14
<Guaranteed_bitrate_UL>	Number	See Chapter 17.1.10
<Guaranteed_bitrate_DL>	Number	See Chapter 17.1.9
<Delivery_order>	Number	See Chapter 17.1.6
<Maximum_SDU_size>	Number	See Chapter 17.1.16
<SDU_error_ratio>	String	See Chapter 17.1.28
<Residual_bit_error_ratio>	String	See Chapter 17.1.29
<Delivery_of_erroneous_SDUs>	Number	See Chapter 17.1.5
<Transfer_delay>	Number	See Chapter 17.1.30
<Traffic_handling_priority>	Number	See Chapter 17.1.31
<Source_statistics_descriptor>	Number	See Chapter 17.1.37
<Signalling_indication>	Number	See Chapter 17.1.38

17.26.4 Notes

- If <Maximum_bitrate_UL>, <Maximum bitrate DL>, <Guaranteed_bitrate_UL>, <Guaranteed_bitrate_DL>, <Maximum_SDU_size> and <Transfer_delay> parameters are set outside the allowed range, an error message will be provided. If the value is selected within the allowed range, it is rounded to the closest allowed value according to the specified steps.

- If <Traffic_class>=0 (conversational) or <Traffic_class>=1 (streaming), <Source_statistics_descriptor> must be provided.
- If <Traffic_class>=2 (interactive), <Signalling_indication> must be provided.

LISA-U1

- <Source_statistics_descriptor> and <Signalling_indication> are not supported.

17.27 3G Quality of Service Profile (negotiated) +CGEQNEG

+CGEQNEG						
Modules	LISA-U SARA-U					
Attributes	Syntax	PIN required	Settings saved	Can be aborted	Response time	Error reference
	full	Yes	No	No	-	+CME Error

17.27.1 Description

This command allows the TE to retrieve the negotiated QoS profiles returned in the Activate PDP Context Accept message. The execution command returns the negotiated QoS profile for the specified <cid>s. The QoS profile consists of a number of parameters, each of which may have a separate value.

17.27.2 Syntax

Type	Syntax	Response	Example
Set	AT+CGEQNEG=[<cid>[,<cid>[,...]]]	+CGEQNEG: <cid>,<Traffic_class>,<Maximum_bitrate_UL>,<Maximum_bitrate_DL>,<Guaranteed_bitrate_UL>,<Guaranteed_bitrate_DL>,<Delivery_order>,<Maximum_SDU_size>,<SDU_error_ratio>,<Residual_bit_error_ratio>,<Delivery_of_erroneous_SDUs>,<Transfer_delay>,<Traffic_handling_priority>,<Source_statistics_descriptor>,<Signalling_indication> [+CGEQNEG: <cid>,<Traffic_class>,<Maximum_bitrate_UL>,<Maximum_bitrate_DL>,<Guaranteed_bitrate_UL>,<Guaranteed_bitrate_DL>,<Delivery_order>,<Maximum_SDU_size>,<SDU_error_ratio>,<Residual_bit_error_ratio>,<Delivery_of_erroneous_SDUs>,<Transfer_delay>,<Traffic_handling_priority>,<Source_statistics_descriptor>,<Signalling_indication> [...]] OK	AT+CGEQNEG=1 +CGEQNEG: 1,2,5760,7168,0,0,0,1480,"1E3","1E5",2,1000,1,0,0 OK
Test	AT+CGEQNEG=?	+CGEQNEG: (list of <cid>s associated with active contexts) OK	+CGEQNEG: (1) OK

17.27.3 Defined values

Parameter	Type	Description
<cid>	Number	See Chapter 17.1.2
<Traffic_class>	Number	See Chapter 17.1.27
<Maximum_bitrate_UL>	Number	See Chapter 17.1.15
<Maximum_bitrate_DL>	Number	See Chapter 17.1.14
<Guaranteed_bitrate_UL>	Number	See Chapter 17.1.10
<Guaranteed_bitrate_DL>	Number	See Chapter 17.1.9
<Delivery_order>	Number	See Chapter 17.1.6
<Maximum_SDU_size>	Number	See Chapter 17.1.16

Parameter	Type	Description
<SDU_error_ratio>	String	See Chapter 17.1.28
<Residual_bit_error_ratio>	String	See Chapter 17.1.29
<Delivery_of_erroneous_SDUs>	Number	See Chapter 17.1.5
<Transfer_delay>	Number	See Chapter 17.1.30
<Traffic_handling_priority>	Number	See Chapter 17.1.31
<Source_statistics_descriptor>	Number	See Chapter 17.1.37
<Signalling_indication>	Number	See Chapter 17.1.38

17.28 Define Secondary PDP context +CGDSCONT

+CGDSCONT						
Modules	LISA-U SARA-U					
Attributes	Syntax	PIN required	Settings saved	Can be aborted	Response time	Error reference
	full	Yes	No	No	-	+CME Error

17.28.1 Description

This command specifies particular PDP context parameter values for a secondary PDP context, identified by the local context identification parameter <cid>, associated to a primary PDP context identified by the local context identification parameter <p_cid>.

 If only the parameter <cid> is provided, the corresponding PDP context becomes undefined.

17.28.2 Syntax

Type	Syntax	Response	Example
Set	AT+CGDSCONT=[<cid>[,<p_cid>[,<d_comp>[,<h_comp>]]]]	OK	AT+CGDSCONT=2,1 OK
Read	AT+CGDSCONT?	+CGDSCONT: <cid>,<p_cid>,<d_comp>,<h_comp> [+CGDSCONT: <cid>,<p_cid>,<d_comp>,<h_comp> [...]] OK	+CGDSCONT: 2,1,0,0 OK
Test	AT+CGDSCONT=?	+CGDSCONT: (range of <cid>s),(list of <cid>s for defined primary contexts),(list of supported <d_comp>s),(list of supported <h_comp>s) OK	+CGDSCONT: (1-11),(1),(0-2),(0-4) OK

17.28.3 Defined values

Parameter	Type	Description
<cid>	Number	See Chapter 17.1.2
<p_cid>	Number	See Chapter 17.1.2
<d_comp>	Number	See Chapter 17.1.3
<h_comp>	Number	See Chapter 17.1.11

17.29 Always-On mode parameters settings +CGPERMSET

+CGPERMSET						
Modules	LISA-U270-62S					
Attributes	Syntax	PIN required	Settings saved	Can be aborted	Response time	Error reference
	full	No	No	No	-	+CME Error

17.29.1 Description

Sets the APN, user ID, password and the Keep Alive timer for the Always-On mode. If the command sets the parameter value out of the allowed range, an ERROR result code is returned whatever is the configuration of +CMEE command.

For sake of simplicity in <cid> management, <cid> uniquely identifies a PDP context within the module. Such PDP context may be defined either with +CGPERMSET or with +CGDCONT command and no check is internally done in SW on which cid has been configured with which command. This assures large flexibility in handling the 11 definable PDP contexts. It is recommended to exploit the whole cid range and to assign Always on PDP contexts and other PDP contexts different <cid> values.

17.29.2 Syntax

Type	Syntax	Response	Example
Set	AT+CGPERMSET=<cid>,<apn>,<id>,<pwd>[,<time>]	OK	
Read	AT+CGPERMSET?	AT+CGPERMSET: <cid>,<apn>,<id>,<pwd>,<time> OK	
Test	AT+CGPERMSET=?	+CGPERMSET: (list of supported <cid>s),, ,(list of supported <time>s) OK	

17.29.3 Defined values

Parameter	Type	Description
<cid>	Number	See Chapter 17.1.2
<APN>	String	See Chapter 17.1.1
<id>	String	User ID to be used in Always-On mode
<pwd>	String	Password to be used in Always-On mode
<time>	Number	Value expressed in minutes of Keep Alive Time to be used in Always-On mode The range goes from 60 to 600. The default value is 120 (min)

17.30 Always-On mode settings +CGPERMACT

+CGPERMACT						
Modules	LISA-U270-62S					
Attributes	Syntax	PIN required	Settings saved	Can be aborted	Response time	Error reference
	full	No	No	No	-	+CME Error

17.30.1 Description

Sets the Always-On mode / On-Demand mode. A protocol level error causes the issuing of the +ALWAYSONERROR URC. If the command sets the parameter value out of the allowed range, an ERROR result code is returned whatever is the configuration of +CMEE command.

17.30.2 Syntax

Type	Syntax	Response	Example
Set	AT+CGPERMACT=<cid>,<mode>	OK	
Read	AT+CGPERMACT?	AT+CGPERMACT: <cid>,<mode>	



Type	Syntax	Response	Example
		OK	
Test	AT+CGPERMACT=?	+CGPERMACT: (list of supported <cid>s), (list of supported <mode>s) OK	
URC		+ALWAYSONERROR OK	

17.30.3 Defined values

Parameter	Type	Description
<cid>	Number	See Chapter 17.1.2
<mode>	Number	Mode set for the module <ul style="list-style-type: none"> 0: On-Demand mode 1: Always-On mode

17.31 Always-On mode check state +CGPERMSTATE

+CGPERMSTATE						
Modules	LISA-U270-62S					
Attributes	Syntax	PIN required	Settings saved	Can be aborted	Response time	Error reference
	full	No	No	No	-	+CME Error

17.31.1 Description

Returns the Always-On state on which the module currently belongs.

17.31.2 Syntax

Type	Syntax	Response	Example
Read	AT+CGPERMSTATE?	AT+CGPERMSTATE: <cid>,<mode> OK	If the On-Demand mode is disabled: +CGPERMSTATE: ,0 OK Otherwise: +CGPERMSTATE: 1,0 OK
Test	AT+CGPERMSTATE=?	+CGPERMSTATE: (list of supported <cid>s),(list of supported <state>s) OK	

17.31.3 Defined values

Parameter	Type	Description
<cid>	Number	See Chapter 17.1.2
<state>	Number	State to which the module belongs <ul style="list-style-type: none"> 0: On-Demand mode state 1: Always-On active state 2: Always-On stand-by state 3: Always-On pending state 4: other unknown state

17.32 Traffic Flow Template +CGTFT

+CGTFT						
Modules	LISA-U SARA-U					
Attributes	Syntax	PIN required	Settings saved	Can be aborted	Response time	Error reference
	full	Yes	No	No	-	+CME Error

17.32.1 Description

Allows the TE to specify a Packet Filter (PF) for a Traffic Flow Template (TFT) that is used in the GGSN for routing of down-link packets onto different QoS flows towards the TE (see the 3GPP TS 23.060 [10] and 3GPP TS 24.008 [30]). A TFT is identified by a <packet filter identifier> and each packet filter also has an <evaluation precedence index>. The set command specifies a Packet Filters to be added to the TFT stored in the MT and used for the context identified by <cid>. This command is effectively an extension of the +CGDCONT and +CGDSCONT AT commands.

The syntax +CGTFT=<cid> causes all of the Packet Filters in the TFT for the specified <cid> to become undefined.

Not all the parameters combinations are allowed in a Packet Filter, some may coexist but others are mutually exclusive. The possible combinations are specified in 3GPP TS 23.060 [10].



A valid packet filter must contain a unique identifier and a unique evaluation precedence index within all TFTs for one PDP address. The network will reject the activation of a secondary context if the corresponding packet filter contains an identifier or an evaluation precedence index which is not unique within all TFTs for one PDP address.

17.32.2 Syntax

Type	Syntax	Response	Example
Set	AT+CGDCONT or AT+CGDSCONT are needed previously AT+CGTFT=[<cid>,<packet_filter_identifier>,<evaluation_precedence_index>[,<source_address_and_subnet_mask>[,<protocol_number_(ipv4)-next_header_(ipv6)>[,<destination_port_range>[,<source_port_range>[,<ipsec_security_parameter_index_(spi)>[,<type_of_service_(tos)__(ipv4)_and_mask-traffic_class_(ipv6)_and_mask>[,<flow_label_(ipv6)>]]]]]]]]]	OK	AT+CGTFT=2,1,1,"10 9.115.183.216.255.255.0.0" OK
Read	AT+CGTFT?	+CGTFT: <cid>,<packet_filter_identifier>,<evaluation_precedence_index>,<source_address_and_subnet_mask>,<protocol_number_(ipv4)-next_header_(ipv6)>,<destination_port_range>,<source_port_range>,<ipsec_security_parameter_index_(spi)>,<type_of_service_(tos)__(ipv4)_and_mask-traffic_class_(ipv6)_and_mask>,<flow_label_(ipv6)> [+CGTFT: <cid>,<packet_filter_identifier>,<evaluation_precedence_index>,<source_address_and_subnet_mask>,<protocol_number_(ipv4)-next_header_(ipv6)>,<destination_port_range>,<source_port_range>,<ipsec_security_parameter_index_(spi)>,<type_of_service_(tos)__(ipv4)_and_mask-traffic_class_(ipv6)_and_mask>,<flow_label_(ipv6)> [...]]	+CGTFT: 2,1,1,"10 9.115.183.216.255.255.0.0",0,"0.0",0 .0",00000000,"0.0",00000 OK



Type	Syntax	Response	Example
Test	AT+CGTFT=?	<p>OK</p> <p>+CGTFT: <PDP_type>,(list of supported <packet_filter_identifier>s),(list of supported <evaluation_precedence_index>s),(list of supported <source_address_and_subnet_mask>s),(list of supported <protocol_number_(ipv4)-next_header_(ipv6)>s),(list of supported <destination_port_range>s),(list of supported <source_port_range>s),(list of supported <ipsec_security_parameter_index_(spi)>s),(list of supported <type_of_service_(tos)_and_mask-traffic_class_(ipv6)_and_mask>s),(list of supported <flow_label (ipv6)>s)</p> <p>[+CGTFT: <PDP_type>,(list of supported <packet_filter_identifier>s),(list of supported <evaluation_precedence_index>s),(list of supported <source_address_and_subnet_mask>s),(list of supported <protocol_number_(ipv4)-next_header_(ipv6)>s),(list of supported <destination_port_range>s),(list of supported <source_port_range>s),(list of supported <ipsec_security_parameter_index_(spi)>s),(list of supported <type_of_service_(tos)_and_mask-traffic_class_(ipv6)_and_mask>s),(list of supported <flow_label (ipv6)>s)</p> <p>[...]</p> <p>OK</p>	<p>+CGTFT: IP,(1-8),(0-255),("0.0.0.0.0.0.0.0-255.255.255.255.255.255.255.255"),(0-255),("0.0-65535.65535"),("0.0-65535.65535"),(00000000-ffffff),("0.0-255.255"),(00000-00000)</p> <p>OK</p>

17.32.3 Defined values

Parameter	Type	Description
<cid>	Number	See Chapter 17.1.2
<packet_filter_identifier>	Number	See Chapter 17.1.19
<evaluation_precedence_index>	Number	See Chapter 17.1.8
<source_address_and_subnet_mask>	String	See Chapter 17.1.32
<protocol_number_(ipv4)-next_header_(ipv6)>	Number	See Chapter 17.1.33
<destination_port_range>	String	See Chapter 17.1.7
<source_port_range>	String	See Chapter 17.1.34
<ipsec_security_parameter_index_(spi)>	Number	See Chapter 17.1.12
<type_of_service_(tos)_and_mask-traffic_class_(ipv6)_and_mask>	String	See Chapter 17.1.35
<flow_label(ipv6)>	Number	See Chapter 17.1.36

17.32.4 Notes

LISA-U

- The read command's information text response does not display the <source_address_and_subnet_mask> parameter entirely in dotted notation, i.e. characters [and] are used to separate subnet mask from source address.

17.33 Read counters of sent or received PSD data +UGCNTRD

+UGCNTRD						
Modules	LEON-G SARA-G					
	LISA-U SARA-U					
Attributes	Syntax	PIN required	Settings saved	Can be aborted	Response time	Error reference
	full	Yes	No	No	-	-

17.33.1 Description

Allows reading the counters for total sent / received bytes for each defined context.

For each active <cid> one result code line is provided by the DCE.



Only if the specific PDP context parameter values for a PDP context are set.



The sent / received bytes are the gross payload evaluated by the protocol stack, therefore they comprise the TCP and IP header bytes and the packets used to open and close the TCP connection.

17.33.2 Syntax

Type	Syntax	Response	Example
Action	AT+UGCNTRD	+UGCNTRD: <cid>,<sent_sess_bytes>,<received_sess_ bytes>,<sent_total_bytes>,<received_ total_bytes> [... +UGCNTRD: <cid>,<sent_sess_bytes>,<received_sess_ bytes>,<sent_total_bytes>,<received_ total_bytes>] OK	AT+UGCNTRD +UGCNTRD: 1, 100, 0, 100, 0 OK
Test	AT+UGCNTRD=?	OK	OK

17.33.3 Defined values

Parameter	Type	Description
<cid>	Number	Local PDP context identifier in the range of 0-255
<sent_sess_bytes>	Number	Sent bytes for the current PSD session
<received_sess_bytes>	Number	Received GPRS session bytes for the current PSD session
<sent_total_bytes>	Number	Total sent bytes
<received_total_bytes>	Number	Total received bytes

17.34 Set/reset counter of sent or received PSD data +UGCNTSET

+UGCNTSET						
Modules	LEON-G SARA-G					
	LISA-U SARA-U					
Attributes	Syntax	PIN required	Settings saved	Can be aborted	Response time	Error reference
	partial	Yes	No	No	-	-

17.34.1 Description

Allows setting the counter for total sent/received bytes for each defined context to zero or any other offset value.



Whenever the total counter for a <cid> is set (to zero or a certain value), the session counter for this <cid> will be set to zero.



If the <cid> equals zero then the total counter for every defined context is set to zero.

 Given offset parameters are ignored in this case.

17.34.2 Syntax

Type	Syntax	Response	Example
Set	AT+UGCNTSET=<cid>,[<total_bytes_sent_offset>,<total_bytes_received_offset>]	OK	AT+UGCNTSET=0,20,20 OK
Test	AT+UGCNTSET=?	+UGCNTSET: (range of <cid>s),(range of <total_bytes_sent_offset>),(range of <total_bytes_received_offset>) OK	+UGCNTSET: (0-255),(0-2147483646),(0-2147483646) OK

17.34.3 Defined values

Parameter	Type	Description
<cid>	Number	Number containing the local PDP context identifier in range of 0-255
<total_bytes_sent_offset>	Number	long Number containing the offset of total sent bytes used for counting in range 0-0x7FFFFFFE
<total_bytes_received_offset>	Number	long Number containing the offset of total received bytes used for counting in range 0-0x7FFFFFFE.

17.34.4 Notes

LEON-G

- It is not possible to set the counters of internal PDP contexts.
- The range of <cid> parameter goes from 0 to 3.

17.35 Multiple PDP contexts

Two PDP context types are defined:

- "external" PDP context: IP packets are built by the DTE, the MT's IP instance runs the IP relay function only;
- "internal" PDP context: the PDP context (relying on the MT's embedded TCP/IP stack) is configured, established and handled via the data connection management *+UPSD*, *+UPSDA* and *+UPSND* AT commands.

Multiple PDP contexts are supported. The DTE can access these PDP contexts either alternatively through the physical serial interface, or simultaneously through the virtual serial ports of the multiplexer (multiplexing mode MUX), with the following constraints:

- Using the MT's embedded TCP/IP stack, only a internal PDP context is supported. This IP instance supports up to 7 sockets;
- Using only external PDP contexts, it is possible to have at most 3 IP instances (with 3 different IP addresses) simultaneously active. If in addition the internal PDP context is used, at most 2 external PDP contexts can be activated.

 SARA-G300 / SARA-G310
Multiple PDP contexts and internal PDP contexts are not supported.

 LEON-G
Using the MT's embedded TCP/IP stack, the IP instance supports up to 16 sockets.

17.36 Primary and secondary PDP contexts

A PDP context can be either **primary** or **secondary**. A secondary PDP context uses the same IP address of a primary PDP context (the usual PDP context activated e.g. via dial-up). The Traffic Flow Filters for such secondary contexts shall be specified according to 3GPP TS 23.060 [10].



The typical usage of the secondary PDP contexts is in VoIP calls, where RTP (speech) packets are conveyed on one PDP context (e.g. the primary one) with a given QoS (e.g. low reliability) whereas SIP signalling is routed on



a different PDP context (e.g. the secondary one, with the same IP address but different port numbers) with a more reliable QoS.

A Traffic Flow Template (i.e. a filter based on port number, specifying relative flow precedence) shall be configured for the secondary context to instruct the GGSN to route down-link packets onto different QoS flows towards the TE.

PDP context type	Activation procedure
Primary	Used to establish a logical connection through the network from the UE to the GGSN with the Quality of Service (QoS) functionality. The UE initiates the PDP context activation: it changes the session management state to active, creates the PDP context, obtains the IP address and reserves radio resources. After the activation, the UE is able to send IP packets over the air interface.
Secondary	Used to establish a second PDP context with the same IP address as the primary PDP context. The two contexts may have different QoS profiles, which makes the feature useful for applications that have different QoS requirements (e.g., IP multimedia) in downlink, based on port number addressing. The access point name, though, will be the same for the primary and secondary PDP contexts.

-  At most 2 secondary PDP contexts may be associated to a primary context.
-  At most 2 secondary PDP contexts can be activated, since the maximum number of PDP contexts, both normal and secondary, is always 3.
-  LEON-G / SARA-G
The secondary PDP contexts are not supported.

18. System features

18.1 Firmware Install Command +UFWINSTALL

+UFWINSTALL						
Modules	LISA-U200-82S					
Attributes	Syntax	PIN required	Settings saved	Can be aborted	Response time	Error reference
	full	No	No	No	-	FW Install Error

18.1.1 Description

Triggers the FW installation procedure, starting from the file (delta binary file) stored in module file system. It could be used as a part of implementation of FOTA procedure. The command causes a SW system reset with network deregistration.

During the update process, the device cannot be used to make calls, even emergency calls. The update process is fault tolerant, even if the battery is suddenly removed.

At the end of successful installation, the main firmware software boots up, NVM and profiles data are set to the default values of the new firmware version and the SIM is reset (the PIN will be required if enabled).

The firmware can be updated using the following interfaces:

- UART with configurable baud rate (only one port is available)
- USB with configurable USB instance

During the update operations, the +UFWINSTALL URC displays the progress indication and the result operation on the interface chosen via +UFWINSTALL command. When the FW update is completed, a URC will notify the final result of the operation.

Example:

```
AT+UFWINSTALL="Delta_FW_90_to_91.upd", 1, 115200
```

```
OK
```

```
+UFWINSTALL: 1
```

```
+UFWINSTALL: 2
```

```
+UFWINSTALL: 3
```

```
+UFWINSTALL: 4
```

```
.....
```

```
+UFWINSTALL: 9
```

```
+UFWINSTALL: 12
```

```
+UFWINSTALL: 15
```

```
.....
```

```
+UFWINSTALL: 99
```

```
+UFWINSTALL: 100
```

```
+UFWINSTALL: 128
```

The "OK" string is printed out just before the FW reset.

The progression of installation is incremental, but the URC step can be different from 1.

The installation is done when the percentage ends with +UFWINSTALL: 100



The last URC with a value greater than 100 indicates the update operation result (e.g. 128 means operation completed with success (for more details refer to [Appendix A.10](#)))

☞ Once the command has been sent correctly, the FW resets and at the next boot up FW install will start.

☞ For more details refer to FW update Application note [\[85\]](#).

18.1.2 Syntax

Type	Syntax	Response	Example
Set	AT+UFWINSTALL=<filename>[,<Serial_Port_Number>[,<BaudRate>]]	OK	AT+UFWINSTALL="Delta_FW_90_to_91.upd",1,115200 OK
Test	AT+UFWINSTALL=?	+UFWINSTALL: "filename", (list of supported <Serial_Port_Number>s), (list of supported <BaudRate>s) OK	+UFWINSTALL: "filename", (0,1,4-6), (19200,38400,57600,115200,230400,460800,921600) OK
URC		+UFWINSTALL:<progress_install>	

18.1.3 Defined values

Parameter	Type	Description
<filename>	String	The delta filename from version 0 to version 1 which has been previously downloaded in FS. The delta file can have different extension
<Serial_Port_Number>	Number	Serial interface where the progress percentage and the information messages will be sent: <ul style="list-style-type: none"> • 0: no info will be shown • 1: UART interface • 4: USB1 • 5: USB2 • 6: USB3 If omitted, the command will take as default value for <Serial_Port_Number> the port where the command is issued.
<BaudRate>	Number	Available baud rates expressed in b/s: <ul style="list-style-type: none"> • 19200 • 38400 • 57600 • 115200 • 230400 • 460800 • 921600 When a USB interface is selected, the parameter has no effect in the FW install configuration. If omitted, the command will take as default value for <BaudRate> the baud rate of the port where the command is issued.
<progress_install>	Integer	Provide the installation progress from 1 to 100 and the update result (see Appendix A.10).

18.1.4 Notes

- Store the delta file into the module file system before starting the install with +UFWINSTALL. Otherwise the "FFS file not found" error is issued. The procedure for FS storing is up to the user (via FTP, +UDWNFILE).

18.2 Firmware update Over AT command (FOAT) +UFWUPD

+UFWUPD						
Modules	LEON-G SARA-G					
	LISA-U SARA-U					
Attributes	Syntax	PIN required	Settings saved	Can be aborted	Response time	Error reference
	partial	No	No	No	-	FOAT Error

18.2.1 Description

Triggers one of the following firmware update types using the Xmodem and Xmodem-1k protocols:

- Firmware image update
- File System (FS) image update
- Firmware and File System images update

Depending on the file format, the update will affect:

- Module firmware: the firmware can be updated only using the file in fls format
- NVM and profiles: they are reset to the factory-programmed values using either the file in dffs or in fls format
- FS: it is updated only using the file in dffs format

 LISA-U2x0-01S / LISA-U200-00S

The released file in fls format contains the File System image. Any filetype option of the +UFWUPD command which involves the update of file system will require the fls file.

 LEON-G

The file in fls format does not allow updating the profile and the NVM. The file in dffs format does not allow updating the profile and the NVM.

 SARA-G

The NVM and the profiles are not updated with the file in dffs format.

 The errors (data corruption, data loss etc) during the Update phase are internally handled by the Xmodem protocol itself; for more details about the error code, see [Appendix A.6](#).

 The selected downloadable file (.fls, .dffs) carries the information of the module type for which it can be used. In case of mismatch, the FOAT procedure stops the download with an error message (see [Appendix A.6](#)) and then starts the old FW present in the module.

 In case of power loss during the update, at the next module wake-up a fault is detected and the module remains in Firmware Update Mode expecting that the upgrade restarts from Xmodem handshake; the FW is corrupted and useless (ERROR2).

 If the FW upgrade ends with an ERROR condition, the module remains in Firmware Update Mode expecting that the upgrade restarts from Xmodem handshake; the FW is corrupted and useless (ERROR2).

 If no data comes to module after AT+UFWUPD command, up to ten NACK are sent and then Firmware Update Mode is dropped out coming back to normal mode; the FW is unchanged and still useable (ERROR1).

 For more details see FW update Application note [\[85\]](#).

18.2.2 Syntax

Type	Syntax	Response	Example
Set	AT+UFWUPD=<filetype>[,<speed>]	+UFWUPD: ONGOING (Sent at new baud rate, if specified)	AT+UFWUPD=0 +UFWUPD: ONGOING
Test	AT+UFWUPD=?	+UFWUPD: (list of supported <filetype>s), (list of supported <speed>s)	+UFWUPD: (0-2),(115200, 230400, 460800, 921600)

Type	Syntax	Response	Example
		OK	OK

18.2.3 Defined values

Parameter	Type	Description
<filetype>	Number	Download type <ul style="list-style-type: none"> • 0: firmware image update (*.fls file) • 1: File System image update (*.dffs file) • 2: firmware and File System image update
<speed>	Number	Baud rate in b/s <ul style="list-style-type: none"> • 115200 (default value) • 230400 • 460800 • 921600

18.2.4 Notes

- If <filetype> is set to 2 make sure the file contains both the firmware and file system images.

SARA-G

- <filetype>=2 is not supported.

SARA-G300 / SARA-G310

- <filetype>=1 is not supported.

LEON-G

- <filetype>=2 is not supported.

18.3 Antenna Detection +UANTR

+UANTR						
Modules	LEON-G SARA-G340 SARA-G350					
	LISA-U SARA-U					
Attributes	Syntax	PIN required	Settings saved	Can be aborted	Response time	Error reference
	full	No	No	No	-	+CME Error

18.3.1 Description

Measures the DC component of load of the GSM antenna (the GPS antenna is RFU). The antenna load is expressed in kOhm.

18.3.2 Syntax

Type	Syntax	Response	Example
Set	AT+UANTR=[<antenna_id>]	+UANTR: <antenna_id>,<antenna_load> OK	AT+UANTR=0 +UANTR: 0,10 OK
Test	AT+UANTR=?	+UANTR: (list of supported <antenna_id>s) OK	+UANTR: (0) OK

18.3.3 Defined values

Parameter	Type	Description
<antenna_id>	Number	Antenna identifier (optional parameter) <ul style="list-style-type: none"> • 0 (default value): GSM antenna • 1: GPS antenna (RFU)



Parameter	Type	Description
<antenna_load>	Number	Measured value in kohm of the antenna load with a resolution of 1 kohm. The range goes from -1 to 53 (only integer values can be assumed), where: <ul style="list-style-type: none"> -1: open circuit 0: short circuit 1: 1 kohm (minimum limit of the measurement range) ... 53: 53 kohm (maximum limit of the measurement range)

18.3.4 Notes

- The load resistor values below the minimum limit of 1 kohm are identified as short circuit (<antenna_load>=0), while values above the maximum limit of 53 kohm are identified as open circuit (<antenna_load>=-1).
- The reported value could differ from the real resistance value of the diagnostic resistor mounted inside the antenna assembly due to antenna cable length, antenna cable capacity and the measurement method.

18.4 ADC read command +UADC

+UADC						
Modules	LEON-G					
Attributes	Syntax	PIN required	Settings saved	Can be aborted	Response time	Error reference
	full	No	No	No	-	+CME Error

18.4.1 Description

Reads the current value of the specified ADC, given in mV. The syntax and the parameters range are shown in the response to the test command if ADC are supported; if no ADC is supported by the modem, an error is returned.

18.4.2 Syntax

Type	Syntax	Response	Example
Set	AT+UADC=<adc_id>	+UADC: <adc_id>,<adc_val> OK	AT+UADC=0 +UADC: 0,480 OK
Test	AT+UADC=?	+UADC: (range of <adc_id>s) OK	+UADC: (0-1) OK

18.4.3 Defined values

Parameter	Type	Description
<adc_id>	Number	ADC identifier
<adc_val>	Number	Current ADC value measured on the specified ADC pin, typical range [0-1920 mV]

18.5 Power saving control (Power SaVing) +UPSV

+UPSV						
Modules	LEON-G SARA-G LISA-U SARA-U					
Attributes	Syntax	PIN required	Settings saved	Can be aborted	Response time	Error reference
	partial	No	Profile	No	-	+CME Error

18.5.1 Description





Sets the UART power saving configuration, but it has a global effect on the module power saving configuration:

- If power saving is enabled (+UPSV=1), the UART interface is cyclically enabled and the module enters idle-mode automatically whenever possible
- If power saving is disabled (+UPSV=0), the UART interface is always enabled and the module does not enter idle-mode
- If power saving is controlled by the UART **RTS** signal (+UPSV=2), the UART interface is enabled and the module does not enter idle-mode as long as the UART **RTS** line is ON
- If power saving is controlled by the UART **DTR** signal (+UPSV=3), the UART interface is enabled and the module does not enter idle-mode as long as the UART **DTR** line is ON

18.5.2 Syntax

Type	Syntax	Response	Example
Set	AT+UPSV=<mode>[,<Timeout>]	OK	AT+UPSV=1,3000 OK
Read	AT+UPSV?	+UPSV: <mode>[,<Timeout>] OK	+UPSV: 1,3000 OK
Test	AT+UPSV=?	+UPSV: (list of supported <mode>s),(list of supported <Timeout>s) OK	+UPSV: (0-3),(40-65000) OK

18.5.3 Defined values

Parameter	Type	Description
<mode>	Number	Power saving configuration <ul style="list-style-type: none"> • 0 (default and factory-programmed value): disabled • 1: enabled <ul style="list-style-type: none"> ◦ The UART is re-enabled from time to time to give to the DTE a chance for the transmission and the module switches from idle to active-mode in a cyclic way. If during the active-mode any data is received, the UART (and the module) is forced to stay "awake" for a time specified by the <Timeout> parameter. Any subsequent data reception during the "awake" period resets and restarts the "awake" timer • 2: power saving is controlled by UART RTS signal: <ul style="list-style-type: none"> ◦ If the RTS state is set to OFF, the power saving mode is allowed ◦ If the RTS state is set to ON, the module shall exit from power saving mode  <mode>=2 is allowed only if HW flow control has been previously disabled on UART interface (e.g. with AT&K0), otherwise the command returns an error response (+CME ERROR: operation not allowed if +CMEE=2).  With <mode>=2 the DTE can start sending data to the module without risk of data loss after having asserted the UART RTS line (RTS sets to ON). • 3: power saving is controlled by UART DTR line: <ul style="list-style-type: none"> ◦ If the DTR state is set to OFF, the power saving mode is allowed ◦ If the DTR state is set to ON, the module shall exit from power saving mode  <mode>=3 is allowed regardless the flow control setting on UART. In particular, the HW flow control can be set on UART during this mode.  With <mode>=3 the DTE can start sending data to the module without risk of data loss after having asserted the UART DTR (DTR sets to ON).
<Timeout>	Number	If <mode>=1 and active-mode entered, it provides the guard period of no reception of characters on the UART interface before entering idle-mode again. It is expressed in GSM frames (4.615 ms) <ul style="list-style-type: none"> • The range goes from 40 to 65000 (approximately from 184 ms to 300 s); the default value is 2000 GSM frames (ca 9.2 s) • This parameter is accepted only if <mode>=1

18.5.4 Notes

- <mode>= 1, <mode>= 2 and <mode>= 3 are applicable only in reference to the UART interface, even if the command is accepted by all the serial interfaces (physical and MUX virtual interfaces). If the command

is issued on USB/SPI/MUX channel, all the AT profiles are accordingly updated, but the setting is only applied to the UART interface.

- `<mode>= 2` requires the disabling of HW flow control only on the UART interface. The other serial interfaces can request the `<mode>=2` for the UART regardless their flow control configuration.
- If `<mode>=2` the CTS line is always set to ON by the module.
- For a detailed explanation of modules' operating modes, modules and interfaces behavior in reference to the `+UPSV` command setting, refer to the corresponding System integration Manual.

LISA-U / SARA-U

- Since these series are equipped with other serial interfaces besides the UART (e.g. USB, SPI), there are some interactions among the power saving mechanisms implemented by the different interfaces. Refer to the corresponding module's System integration Manual for a detailed description.

For power consumption minimization, a DTE could require to set `<mode>=1` or `<mode>=2` or `<mode>=3` (more likely 2 or 3), even if the UART is not used (or even connected). In this condition, the autobauding should be disabled on the UART interface. Otherwise, the `+UPSV` setting could be not allowed on the other available AT interfaces (e.g. USB) (ERROR result is returned). If UART is not accessible, the autobauding can be disabled on UART only by change the `+IPR` configuration from value 0 (autobauding) to a different value on the stored AT profile, that is with the procedure described in [Appendix B.3](#) applied on the other available AT interfaces (e.g. USB). If this procedure cannot be performed, the `UPSV <mode>=1` or `<mode>=2` or `<mode>=3` can be set on other available AT interfaces on the condition that the module UART has not pending data to send (that is URCs or the greeting message, since the UART is not used by the DTE). Basically, this can be possible only in case `+UPSV` command is issued as the first command after the module boot.

LISA-U1 / LISA-U2x0-01S / LISA-U200-00S

- `<mode> =3` is not supported.

SARA-G

- `<mode> =3` is not supported.
- if `<mode>=2` the CTS line follows the module power saving state if `RTS` is set to OFF.

SARA-G300 / SARA-G310

- If a valid reference clock signal is not provided to the EXT32K input pin, the `<mode>=1` and `<mode>=2` does not change the power saving configuration of the UART and the module: the UART is always enabled and the module does not enter idle mode as for `<mode>=0`.

LEON-G

- `<mode> =3` is not supported.
- if `<mode>=2` the CTS line follows the module power saving state if `RTS` is set to OFF.

18.6 End User Test +UTEST

+UTEST						
Modules	LEON-G SARA-G					
	LISA-U SARA-U					
Attributes	Syntax	PIN required	Settings saved	Can be aborted	Response time	Error reference
	full	No	No	No	-	+CME Error

18.6.1 Description

Sets the module in non-signalling (or test) mode, or returns to signalling (or normal) mode.

In test/non-signalling mode the module switches off the 2G/3G/4G protocol stack for performing single tests which could not be performed during signalling, since the radio frequency part is directly controlled by the test.



The usage of this command shall be restricted to controlled (shielded chamber/box) environments and for test purpose only. Improper usage of this command on real network could disturb other users and the network itself.

When entering test mode, it is possible to sequentially trigger the following actions for testing purposes:

- 2G transmission of GSM burst sequence on the desired channel and power level (only one time slot configuration is available)
- 2G transmission of 8-PSK modulation burst sequence on the desired channel and power level (only one time slot configuration is available)
- 3G transmission of WCDMA signal on the desired channel and power level
- 4G transmission of LTE SC-FDMA OFDM signal (5 MHz bandwidth) in the desired channel in FDD or TDD band and power level
- Receiving signal detection and RF level measurement on the desired 2G, 3G or 4G (LTE) channel
- Receiving signal detection at diversity or secondary antenna input and RF level measurement on the desired 2G, 3G or 4G (LTE) channel

 The command only accepts the parameters set supported by the specific module version. When an unsupported parameter is issued an error result code will be provided ("+CME ERROR: operation not supported" if +*CME* is set to 2).

The execution of these actions is performed in non-signalling mode. In Normal mode:

- The only allowed +UTEST command is the AT+UTEST=1 used to enable testing interface in the non-signalling mode
- All other +UTEST commands return an error result code ("+CME ERROR: operation not allowed" if +*CME* is set to 2)

 Set the <mode> parameter of AT+COPS command to 2 before entering the non-signalling mode, otherwise an error result code ("+CME ERROR: operation not allowed" if +*CME* is set to 2) is provided.

In non-signalling mode:

- The module only accepts +UTEST commands

 The +*CME* command can only be set in Normal mode.

To return to the normal mode perform one of these actions:

- A module reset
- Power off the module
- Send AT+UTEST=0

 See the End User Test Application Note for further test command examples [78].

18.6.2 Syntax

Type	Syntax	Response	Example
Set	AT+UTEST=<mode>,[<par1>],[<par2>],[<par3>],[<par4>],[<par5>]	If <mode>=0 or 1	AT+UTEST=0
		OK	OK
		If <mode>=2 or 3	AT+UTEST=2,124,250
		+UTEST: [<par1>,<par2>],[<par3>,<par4>,<par5>],[<min>,<avg>,<max>]	+UTEST: 124,250,-80,-80,-80
		OK	OK
Read	AT+UTEST?	+UTEST: <mode>	+UTEST: 1
		OK	OK
Test	AT+UTEST=?	+UTEST: (list of supported <mode>s)	+UTEST: (0-3)
		OK	OK



18.6.3 Defined values



Parameter	Type	Description
<mode>	Number	Test mode setting: <ul style="list-style-type: none"> • 0: the module returns to the module normal mode

Parameter	Type	Description
		<ul style="list-style-type: none"> 1: the module enters non-signalling mode 2: RX test mode (measuring the antenna level estimation of the received RF signal) 3: TX test mode (GSMK/8-PSK burst or transmission in 3G bands)
<par1>..<par5>	Number	Parameters needed for each selected mode as reported in the table below

18.6.4 Notes

- RX mode setting (<mode>=2)

Par	Description	Range	Default	Notes
<par1>	Channel	0 ÷ 165535	32	<p>RX channel 2G mode: for 850, 900, 1800 bands the value corresponds to ARFCN while for 1900 band an offset of 32768 is added.</p> <ul style="list-style-type: none"> [0-124]: GSM 900 MHz [128-251]: GSM 850 MHz [512-885]: DCS 1800 MHz [975-1023]: EGSM 900 MHz [33280-33578]: PCS 1900 MHz (corresponding to ARFCN 512-810 range in band 1900) <p>RX channel 3G mode: the value corresponds to UARFCN, additional channels available in some 3G bands are not supported.</p> <ul style="list-style-type: none"> [1537-1738]: band IV (1700 MHz) [2937-3088]: band VIII (900 MHz) [4357-4458]: band V (850 MHz) / band VI (800 MHz) / band XIX (800 MHz) (additional not supported, band VI and XIX are subsets) [9662-9938]: band II (1900 MHz) (additional not supported) [10562-10838]: band I (2100 MHz) <p>RX channel 4G mode: the value corresponds to EARFCN with an offset of 100000.</p> <ul style="list-style-type: none"> [101950-102399]: FDD band 4 (EARFCN range 1950 - 2399) [105180-105279]: FDD band 13 (EARFCN range 5180 - 5279) [101200-101949]: FDD band 3 (EARFCN range 1200 - 1949) [102750-103449]: FDD band 7 (EARFCN range 2750 - 3449) [106150-106449]: FDD band 20 (EARFCN range 6150 - 6449) [137750-138249]: TDD band 38 (EARFCN range 37750 - 38249) [100000-100599]: FDD band 1 (EARFCN range 0 - 599) [100600-101199]: FDD band 2 (EARFCN range 600 - 1199) [102400-102649]: FDD band 5 (EARFCN range 2400 - 2649) [103450-103799]: FDD band 8 (EARFCN range 3450 - 3799) [105730-105849]: FDD band 17 (EARFCN range 5730 - 5849) <p> Only the values indicated in the above ranges are valid, otherwise an error result code will be provided ("CME ERROR: operation not supported" if +CME is set to 2)</p> <p> An error result code will be provided ("CME ERROR: operation not supported" if +CME is set to 2) if the RX channel parameter value belongs to a not supported technology mode (2G or 3G or 4G mode) or band.</p>



Par	Description	Range	Default	Notes
<par2>	Time	1 ÷ 600000	1000	Time interval for RX test expressed in ms
<par3>	Antenna Diversity	0 ÷ 1	0	Receiver path: <ul style="list-style-type: none"> • 0: Main / primary antenna • 1: Diversity / secondary antenna The parameter is available only if supported, otherwise an error result code will be provided ("CME ERROR: operation not supported" if +CME is set to 2)
<min>	Minimum antenna RF level estimation	-100 ÷ -20		Expressed in dBm, for 2G mode  In 3G / 4G mode the range goes from -90 to -20
<avg>	Average antenna RF level estimation	-100 ÷ -20		Expressed in dBm, for 2G mode  In 3G / 4G mode the range goes from -90 to -20
<max>	Maximum antenna RF level estimation	-100 ÷ -20		Expressed in dBm, for 2G mode  In 3G / 4G mode the range goes from -90 to -20

- RX mode test command examples

Command	Response	Description
AT+UTEST=2	+UTEST:32,1000,-89,-88,-87 OK	The module measures the antenna RX level at RX channel 32 band GSM900 for 1 s interval. After this time the module provides the response.  In the example -89,-88,-87 are the antenna RF level estimation: the numbers are just an example
AT+UTEST=2,885,5000	+UTEST:885,5000,-66,-65,-65 OK	The module measures the antenna RX level at RX channel 885 band DCS1800 for 5 s interval. After this time the module provides the response.
AT+UTEST=2,10562,2000	+UTEST:10562,2000,-60,-60,-59 OK	The module measures the antenna RX level at RX channel 10562 band B1 for 2 s interval on the main antenna path. After this time the module provides the response.
AT+UTEST=2,10562	+UTEST:10562,1000,0,-85,-85,-85 OK	The module measures the antenna RX level at RX channel 10562 band B1 for 1 s interval on the main antenna path. After this time the module provides the response.
AT+UTEST=2,65,3000,0	+UTEST:65,3000,0,-63,-62,-62 OK	The module measures the antenna RX level at RX channel 65 band GSM900 for 3 s interval on the main antenna path. After this time the module provides the response.
AT+UTEST=2,4357,,1	+UTEST:4357,1000,1,-51,-51,-51 OK	The module measures the antenna RX level at RX channel 4357 band B5 for 1 s interval on the diversity antenna path. After this time the module provides the response.
AT+UTEST=2,102174,500,0	+UTEST:102174,500,0,-71,-70,-70 OK	The module measures the antenna RX level at RX channel 2174 band FDD 4 for 0.5 s interval on the primary antenna path. After this time the module provides the response.
AT+UTEST=2,105230,,1	+UTEST:105230,1000,1,-72,-71,-70 OK	The module measures the antenna RX level at RX channel 5230 band FDD 13 for 1 s interval on the secondary antenna path. After this time the module provides the response.

- TX mode setting (<mode>=3)

Par	Description	Range	Default	Notes
<par1>	Tx channel	0 ÷ 165535	32	TX channel 2G mode: for 850, 900, 1800 bands the value corresponds to ARFCN while for 1900 band an offset of 32768 is added. <ul style="list-style-type: none"> • [0-124]: GSM 900 MHz • [128-251]: GSM 850 MHz • [512-885]: DCS 1800 MHz • [975-1023]: EGSM 900 MHz • [33280-33578]: PCS 1900 MHz (corresponding to ARFCN 512-810 range in band 1900)

Par	Description	Range	Default	Notes
				<p>TX channel 3G mode: the value corresponds to UARFCN, additional channels available in some 3G bands are not supported.</p> <ul style="list-style-type: none"> [1312-1513]: band IV (1700 MHz) [2712-2863]: band VIII (900 MHz) [4132-4233]: band V (850 MHz)/ band VI (800 MHz)/ band XIX (800 MHz)(additional not supported, band VI and XIX are subsets) [9262-9538]: band II (1900 MHz)(additional not supported) [9612-9888]: band I (2100 MHz) <p>TX channel 4G mode: the value corresponds to EARFCN with an offset of 100000.</p> <ul style="list-style-type: none"> [118000-118599]: FDD band 1 (EARFCN range 18000 - 18599) [118600-119199]: FDD band 2 (EARFCN range 18600 - 19199) [119950-120399]: FDD band 4 (EARFCN range 19950 - 20399) [119200-119949]: FDD band 3 (EARFCN range 19200 - 19949) [120400-120649]: FDD band 5 (EARFCN range 20400 - 20649) [120750-121449]: FDD band 7 (EARFCN range 20750 - 21449) [121450-121799]: FDD band 8 (EARFCN range 21450 - 21799) [123180-123279]: FDD band 13 (EARFCN range 23180 - 23279) [123730-123849]: FDD band 17 (EARFCN range 23730 - 23849) [124150-124449]: FDD band 20 (EARFCN range 24150 - 24449) [137750-138249]: TDD band 38 (EARFCN range 37750 - 38249) <p> Only the values indicated in the above ranges are valid, otherwise an error result code will be provided ("CME ERROR: operation not supported" if +CME is set to 2)</p> <p> An error result code will be provided ("CME ERROR: operation not supported" if +CME is set to 2) if the TX channel parameter value belongs to a not supported technology mode (2G or 3G or 4G mode) or band.</p>
<par2>	Power control Level	-56 ÷ 24	5	<p>For 2G mode: PCL (power control level). The allowed values depend on the related <par1> value: lower numbers means higher power level.</p> <ul style="list-style-type: none"> [0-19]: GSM 850 and 900, if <par2> is less than 5 the handling is the same for <par2>=5 [0-15]: DCS 1800 and PCS 1900 <p>In case <par4> is set to 2 (8-PSK modulation) the range is as below. Other values are valid but behave as the indicated level</p> <ul style="list-style-type: none"> [0-19]: GSM 850 and 900 if <par2> is less than 8 the handling is the same for <par2>=8 [0-15]: DCS 1800 and PCS 1900; if <par2> is less than 2 the handling is the same for <par2>=2 <p>For 3G mode: Absolute output power [dBm]</p> <ul style="list-style-type: none"> [-56 ÷ 24] for all the bands <p>For 4G mode: Absolute output power [dBm]</p> <ul style="list-style-type: none"> [-40 ÷ 24] for all the bands

Par	Description	Range	Default	Notes
<par3>	Training Seq (TSC)	0 ÷ 7	5	<p> Only the values indicated in the above ranges are valid, otherwise an error result code will be provided ("CME ERROR: operation not supported" if +CME is set to 2)</p> <p>Training sequence to be used (to be changed only in case of link with network simulator, else use default)</p>

<par4>	Modulation Mode	1 ÷ 2	1	Modulation mode
				<p>In 3G / 4G mode the values is unused.</p> <ul style="list-style-type: none"> 1: GMSK normal modulation including TSC 2: 8-PSK normal modulation including TSC <p>In 3G / 4G mode the parameter is unused.</p> <p>WCDMA modulation is automatically set using for <par1> a UARFCN value.</p> <p>LTE SC-FDMA OFDM modulation (5 MHz bandwidth), FDD or TDD, is automatically set using for <par1> an EARFCN value.</p>
<par5>	Time	0 ÷ 600000	1000	Time interval for TX test expressed in ms
				<ul style="list-style-type: none"> 0: burst sequence is continuously transmitted. In this case the command will immediately return the information text response. The command line will be immediately available for any +UTEST command. Provide AT+UTEST=1 command to stop the burst sequence transmission, any other +UTEST commands can be set and the current sequence transmission is stopped.

• TX mode test command examples

Command	Response	Description
AT+UTEST=3,32,7,5	+UTEST:32,7,5,1,1000 OK	The module will transmit for 1 s interval 1 slot burst sequence at TX channel 32 GSM900 at PCL 5 using training sequence 5 and normal GMSK modulation
AT+UTEST=3,65,8,,2,5000	+UTEST:65,8,5,2,5000 OK	The module will transmit for 5 s interval 1 slot burst sequence at TX channel 65 GSM900 at PCL 8 (gamma 6, 27 dBm) using training sequence 5 and normal 8-PSK modulation
AT+UTEST=3,660,,,0	+UTEST:660,5,5,1,0 OK	The module will transmit continuously 1 slot burst sequence at TX channel 660 DCS1800 at PCL 5 using training sequence 5 and normal GMSK modulation
AT+UTEST=3,9612,22,,,2000	+UTEST:9612,22,5,1,2000 OK	The module will transmit for 2 s interval at TX channel 9612 band B1 at 22 dBm power level using WCDMA modulation
AT+UTEST=3,120399,15,,,3000	+UTEST: 120399,15,5,1,3000 OK	The module transmits for 3 s interval at TX channel 20399 band FDD 4 at 15 dBm power level using SC-FDMA OFDM modulation 5 MHz bandwidth
AT+UTEST=3,123230,-10,,,0	+UTEST: 123230,-10,5,1,0 OK	The module continuously transmits at TX channel 23230 band FDD 13 at -10 dBm power level using SC-FDMA OFDM modulation 5 MHz bandwidth

18.7 Smart temperature Supervisor +USTS

+USTS						
Modules	LEON-G SARA-G340 SARA-G350					
	LISA-U SARA-U					
Attributes	Syntax	PIN required	Settings saved	Can be aborted	Response time	Error reference
	partial	No	Profile	No	-	+CME Error

18.7.1 Description

Allows to enable/disable the Smart Temperature Supervisor feature.

When the feature is enabled the internal temperature is measured via the internal temperature sensor.

If the measured value goes over the t_{+1} threshold or below the t_{-1} threshold an URC will be sent to notify a warning: the module is still in a valid and good working condition.

If the measured value goes over the t_{+2} threshold or below the t_{-2} threshold an URC will be sent to notify the dangerous working condition. This status will be notified and the device will start the shutting down procedure to avoid damaging it.

 The shutting down procedure is performed only if $\langle \text{mode} \rangle = 1$: an URC is sent to notify this.

 For security reasons the shut down is suspended in case of emergency call in progress. In this case the device will switch off at call termination: an URC will be sent to notify this.

 If the feature is disabled ($\langle \text{mode} \rangle = 0$ and $\langle \text{mode} \rangle = 2$) there's no embedded protection against not allowed temperature working conditions.

 For more details on Smart Temperature Supervisor feature, refer to the corresponding module System integration Manual.

18.7.2 Syntax

Type	Syntax	Response	Example
Set	AT+USTS= $\langle \text{mode} \rangle$	OK	AT+USTS=0 OK
Read	AT+USTS?	+USTS: $\langle \text{mode} \rangle$ OK	+USTS: 0 OK
Test	AT+USTS=?	+USTS: (list of supported modes) OK	+USTS: (0-2) OK
URC		+UUSTS: $\langle \text{mode} \rangle, \langle \text{event} \rangle$	+UUSTS: 1,1

18.7.3 Defined values

Parameter	Type	Description
$\langle \text{mode} \rangle$	Number	Enable / disable the smart temperature mode <ul style="list-style-type: none"> 0 (default value and factory-programmed value): feature disabled 1: Smart Temperature feature enabled: the indication and shutting down are performed 2: Smart Temperature Indication enabled
$\langle \text{event} \rangle$	Number	Provides the event status <ul style="list-style-type: none"> -2: temperature below t_{-2} threshold -1: temperature below t_{-1} threshold 0: temperature inside the allowed range - not close to the limits 1: temperature above t_{+1} threshold 2: temperature above the t_{+2} threshold 10: timer expired and no emergency call is in progress, shutdown phase started 20: emergency call ended, shutdown phase started 100: error during measurement

18.7.4 Notes

LEON-G

- $\langle \text{event} \rangle = 100$ is not supported.

18.8 MSPR profile handling configuration +UDCONF=40

+UDCONF=40						
Modules	LISA-U200-01S LISA-U200-02S LISA-U200-52S LISA-U200-62S LISA-U200-82S LISA-U230 LISA-U260 LISA-U270 SARA-U					
Attributes	Syntax	PIN required	Settings saved	Can be aborted	Response time	Error reference
	partial	No	<i>NVM</i>	No	-	<i>+CME Error</i>

18.8.1 Description

The multi-slot transmission power can be reduced according to the 3GPP specifications and set to a defined threshold.

In 3G mode (i.e. UMTS radio access), the maximum output power cannot be set through the AT command, but is automatically set by the module according to the UE Maximum Power Reduction for the nominal maximum output power with HS-DPCCH and E-DCH defined by 3GPP specifications.

In 2G mode (i.e. GPRS and EDGE radio access), the maximum output power in GMSK or 8-PSK multi-slot configuration can be set by selecting the active multi-slot power reduction profile within the available profiles defined in [Table 13](#) according to 3GPP specifications.

The maximum output power in GMSK or 8-PSK multislot configuration depends on the active MSPR profile set by the AT command and the number of active Tx slots set by the network, as described in [Table 13](#):

Active Tx slots	MSPR Profile 0	MSPR Profile 1	MSPR Profile 2	MSPR Profile 3
1	0	0	0	0
2	3	1	0	0
3	4,8	2,8	0,8	0
4	6	4	2	0

Table 13: Power reduction (dBm)

 The changes in the user defined power reduction are effective after reboot.

18.8.2 Syntax

Type	Syntax	Response	Example
Set	AT+UDCONF=40,<GMSK_profile>[,<8PSK_profile>]	OK	AT+UDCONF=40,2,3 OK
Set	AT+UDCONF=40	+UDCONF: 40,<GMSK_profile>,<8PSK_profile> OK	AT+UDCONF=40 AT+UDCONF: 40,2,2 OK

18.8.3 Defined values

Parameter	Type	Description
<GMSK_profile>	Number	User defined power reduction: MSPR GMSK profile (range 0-3). The factory-programmed value is 2
<8PSK_profile>	Number	User defined power reduction: MSPR 8-PSK profile (range 0-3). This parameter is optional: if omitted, the MSPR 8-PSK profile is not affected. The factory-programmed value is 2. The parameter is significant only for cellular modules supporting 8-PSK in uplink.

18.8.4 Notes

- For AT&T certification: the 8-PSK MSPR profile should be limited to values 2 and 3.

LISA-U

- Modules are certified with defined MSPR profiles. If the user changes the profile classes during the certification process, the product PICS must be changed accordingly.

18.9 Configure the Data Channel +UDATACHANNEL

+UDATACHANNEL						
Modules	LISA-U SARA-U					
Attributes	Syntax	PIN required	Settings saved	Can be aborted	Response time	Error reference
	full	No	No	No	-	+CME Error

18.9.1 Description

Configures the serial channel over which CSD or PSD data shall be routed during a data connection (initiated by the ATD or AT+CGDATA commands), after the CONNECT has been received.

As a factory-programmed setting, the data is routed on the same channel where the connection is established.

The channels are identified by a string made up of a trailing forward slash followed by the device type name and a numerical index, separated by a forward slash. For example:

- "/USBCDC/0" is the 1st USB channel
- "/tyCo/2" is the 3rd UART/SPI channel
- "/mux/1" is the 2nd multiplexer channel

The MUX channels are available only if the mux is activated.

Channel identifier (Device name)	Description
"/tyCo/0"	UART 0
"/tyCo/2"	SPI
"/USBCDC/0"	USB channel #0
"/USBCDC/1"	USB channel #1
"/USBCDC/2"	USB channel #2
"/USBCDC/4"	USB channel #4
"/mux/1"	MUX channel #1
"/mux/2"	MUX channel #2
"/mux/3"	MUX channel #3
"/mux/4"	MUX channel #4
"/mux/5"	MUX channel #5
"/mux/6"	MUX channel #6
"/mux/7"	MUX channel #7
"/mux/8"	MUX channel #8



An error message will be provided if the referenced channel is not active / available.

18.9.2 Syntax

Type	Syntax	Response	Example
Set	AT+UDATACHANNEL=<mode>,<csd_psd_flag>,<ctrl-tid-path>,<tidpath>[,<connect_flag>]	OK	AT+UDATACHANNEL=1,1,"/mux/1","/mux/2",0
Test	AT+UDATACHANNEL=?	+UDATACHANNEL: (list of <mode>s),(list of <csd_psd_flag>'s), (list of <connect_flag>'s) OK	+UDATACHANNEL: (0-2),(0,1),(0,1) OK

18.9.3 Defined values

Parameter	Type	Description
<mode>	Number	<ul style="list-style-type: none"> • 0: disable the routing • 1: enable the routing • 2: query current setting for the type of data specified by <csd_psd_flag> and the channel referenced by <ctrl-tidpath>; the <tid-path> must not be set.
<csd_psd_flag>	Number	<ul style="list-style-type: none"> • 0 configure the channel for a CSD connection • 1 configure the channel for a PSD connection

Parameter	Type	Description
<ctrl-tid-path>	String	• Interface for which the data routing mechanism shall be enabled
<tid-path>	String	Interface to which a data call shall be routed
<connect_flag>	Number	• 0 No Reporting on the data channel (neither CONNECT nor NO CARRIER) • 1 Reporting on the data channel enabled (= CONNECT and NO CARRIER)

18.10 Rx Diversity +URXDIV

+URXDIV						
Modules	LISA-U230					
Attributes	Syntax	PIN required	Settings saved	Can be aborted	Response time	Error reference
	full	No	<i>NVM</i>	No	-	<i>+CME Error</i>

18.10.1 Description

Controls the 3G Rx Diversity and 2G DARP during runtime.

The features can be enabled or disabled during operation. Specifying the 2G DARP is optional.

Refer to 3GPP TS 25.101 [64] and 3GPP TS 45.005 [65].



u-blox cellular modules are certified according to all the capabilities and options stated in the Protocol Implementation Conformance Statement document (PICS) of the module. The PICS, according to 3GPP TS 51.010-2 [83] and 3GPP TS 34.121-2 [84], is a statement of the implemented and supported capabilities and options of a device. If the user changes the command settings during the certification process, the PICS of the application device integrating a u-blox cellular module must be changed accordingly.

18.10.2 Syntax

Type	Syntax	Response	Example
Set	AT+URXDIV=<RxDiv3G>[,<DARP>]	OK	AT+URXDIV=1,3 OK
Read	AT+URXDIV?	+URXDIV: <RxDiv3G>,<DARP> OK	+URXDIV: 1,3 OK
Test	AT+URXDIV=?	+URXDIV: (list of supported <RxDiv3G>'s),(list of supported <DARP>'s) OK	+URXDIV: (0-1),(1-3) OK

18.10.3 Defined values

Parameter	Type	Description
<RxDiv3G>	Number	Rx diversity enable/disable. Allowed values: <ul style="list-style-type: none"> • 0: 3G Rx Diversity disabled • 1 (factory-programmed value): 3G Rx Diversity enabled
<DARP>	Number	DARP Phase and mode. Allowed values: <ul style="list-style-type: none"> • 1: DARP Phase 1 • 2: DARP Phase 2 - traffic only • 3 (default and factory-programmed value): DARP Phase 2 - always on

18.10.4 Notes

- It is possible to set the parameters only if the module is not registered to the network (+COPS=2).
- The diversity receiver is provided to improve the quality and reliability of the wireless link on all 2G and 3G operating bands except 2G DCS 1800.
- The command saves the setting in NVM.

18.11 RING line handling +URING

+URING								
Modules	LISA-U200-02S	LISA-U200-52S	LISA-U200-62S	LISA-U200-82S	LISA-U260-02S	LISA-U270-02S	LISA-U270-62S	SARA-U
Attributes	Syntax	PIN required	Settings saved	Can be aborted	Response time	Error reference		
	full	No	<i>NVM</i>	No	-	<i>+CME Error</i>		

18.11.1 Description

Configures the RING line handling of the UART interface for other events besides the usual ones, that is the incoming call indication (RING)(linked to the "RING" URC) and the incoming SMS indication (linked to the "+CMT: ." and the "+CMTI: ." URCS).

The RING line will be asserted when one of the configured events will occur and it remains asserted for 1 s unless another configured event will happen (in this case the 1 s timer will be started again). Same behavior will be applied if the events are the incoming call or the incoming SMS.

18.11.2 Syntax

Type	Syntax	Response	Example
Set	AT+URING=<mode>	OK	AT+URING=1 OK
Read	AT+URING?	+URING: <mode> OK	+URING: 1 OK
Test	AT+URING=?	+URING: (list of the supported <mode>s) OK	+URING: (0-3) OK

18.11.3 Defined values

Parameter	Type	Description
<mode>	Number	Configures the RING line handling: <ul style="list-style-type: none"> 0 (factory-programmed value): feature disabled (RING line is asserted only on incoming call and incoming SMS) 1: RING line asserted for all the URCS 2: RING line asserted for all the incoming data (PPP, Direct Link, sockets, FTP) 3: RING line asserted for all URCS and all incoming data (PPP, Direct Link, sockets, FTP)

18.12 PPP/LCP silent mode configuration +UDCONF=0

+UDCONF=0						
Modules	LEON-G SARA-G					
Attributes	Syntax	PIN required	Settings saved	Can be aborted	Response time	Error reference
	full	No	No	No	-	<i>+CME Error</i>

18.12.1 Description

Configures the advanced settings for the PPP/LCP silent mode. It means that it is possible to configure whether the module must wait for the first LCP frame or send the first LCP frame while establishing a PPP connection.

18.12.2 Syntax

Type	Syntax	Response	Example
Set	AT+UDCONF=0,<ppp_lcp_silent_mode>	OK	AT+UDCONF=0,0 OK
Read	AT+UDCONF=0	AT+UDCONF: 0,<ppp_lcp_silent_mode> OK	AT+UDCONF=0 AT+UDCONF: 0,0 OK

18.12.3 Defined values

Parameter	Type	Description
<ppp_lcp_silent_mode>	Number	Enables/disables the PPP-LCP silent mode. Allowed values: <ul style="list-style-type: none"> • 0: silent mode disabled, the module sends the first LCP frame • 1 (factory-programmed value): silent mode enabled, the module waits for the other end to start first

18.13 IPv6 configuration +UDCONF=66

+UDCONF=66						
Modules	SARA-U					
Attributes	Syntax	PIN required	Settings saved	Can be aborted	Response time	Error reference
	full	No	NVM	No	-	+CME Error

18.13.1 Description

Configures IPv6 support.

 If IPv6 is not supported, also IPv4v6 is not supported.

 The configuration will be effective at the next power on.

18.13.2 Syntax

Type	Syntax	Response	Example
Set	AT+UDCONF=66,<IPv6_conf>	OK	AT+UDCONF=66,1 OK
Set	AT+UDCONF=66	+UDCONF: 66,<IPv6_conf> OK	AT+UDCONF=66 +UDCONF: 66,0 OK

18.13.3 Defined values

Parameter	Type	Description
<IPv6_conf>	Number	IPv6 support enable / disable: <ul style="list-style-type: none"> • 0 (factory-programmed value): IPv6 support disabled • 1: IPv6 support enabled

19. GPIO

19.1 Introduction

The chapter provides the description of AT commands used to manage the GPIO pins provided by u-blox cellular modules.

19.1.1 GPIO functions

On u-blox cellular modules, GPIO pins can be opportunely configured as general purpose input or output. Moreover GPIO pins of u-blox cellular modules can be configured to provide custom functions via **+UGPIOC** AT command. The custom functions availability can vary depending on the u-blox cellular modules series and version: see [Table 14](#), [Table 15](#), [Table 16](#) and [Table 17](#) for an overview of the custom functions supported by u-blox cellular modules.

<gpio_mode>	Function	LEON-G
0	Output	Supported
1	Input	Supported
2	Network status indication	Supported
3	GNSS supply enable	Supported
4	GNSS data ready	Supported
5	GNSS RTC sharing	Supported
7	SIM Card Detection	Not Supported
8	Headset Detection	Supported
9	GSM Tx burst indication	Not Supported
10	Module operating status indication	Not Supported
11	Module functionality status indication	Not Supported
12	I ² S digital audio interface	Not Supported
13	SPI serial interface	Not Supported
255	Pad disabled	Supported

Table 14: GPIO custom functions overview (LEON-G series)

<gpio_mode>	Function	SARA-G340 / SARA-G350
0	Output	Supported
1	Input	Supported
2	Network status indication	Supported
3	GNSS supply enable	Supported
4	GNSS data ready	Supported
5	GNSS RTC sharing	Supported
9	GSM Tx burst indication	Supported
255	Pad disabled	Supported

Table 15: GPIO custom functions overview (SARA-G340 / SARA-G350 series)

<gpio_mode>	Function	LISA-U1 series	LISA-U200-00S	LISA-U2 series (except LISA-U200-00S)
0	Output	Supported	Supported	Supported
1	Input	Supported	Supported	Supported
2	Network status indication	Supported	Supported	Supported
3	GNSS supply enable	Supported	Not Supported	Supported
4	GNSS data ready	Supported	Not Supported	Supported
5	GNSS RTC sharing	Supported	Not Supported	Supported
7	SIM Card Detection	Supported	Supported	Supported
8	Headset Detection	Not Supported	Not Supported	Not Supported
9	GSM Tx burst indication	Supported	Supported	Supported

<gpio_mode>	Function	LISA-U1 series	LISA-U200-00S	LISA-U2 series (except LISA-U200-00S)
10	Module operating status indication	Not Supported	Not Supported	Supported
11	Module functionality status indication	Not Supported	Not Supported	Supported
12	I ² S digital audio interface	Not Supported	Not Supported	Supported
13	SPI serial interface	Not Supported	Not Supported	Supported
255	Pad disabled	Supported	Supported	Supported

Table 16: GPIO custom functions overview (LISA-U series)

<gpio_mode>	Function	SARA-U2 series
0	Output	Supported
1	Input	Supported
2	Network status indication	Supported
3	GNSS supply enable	Supported
4	GNSS data ready	Supported
5	GNSS RTC sharing	Supported
7	SIM Card Detection	Supported
8	Headset Detection	Not Supported
9	GSM Tx burst indication	Supported
10	Module operating status indication	Supported
11	Module functionality status indication	Supported
12	I ² S digital audio interface	Supported
13	SPI serial interface	Not Supported
255	Pad disabled	Supported

Table 17: GPIO custom functions overview (SARA-U series)

The configuration of the GPIO pins (i.e. the setting of the parameters of the `+UGPIOC` AT command) is saved in the NVM and used at the next power-on.

19.1.2 GPIO mapping

The number of available GPIO pins and their mapping can vary depending on the u-blox cellular modules series and version. The GPIOs mapping for different u-blox cellular modules is reported in [Table 18](#), [Table 19](#), [Table 20](#), [Table 21](#), [Table 22](#) and [Table 23](#).

 See the corresponding module System Integration Manual for the supported functions by each GPIO.

<gpio_id>	Pin name	Pin number	Factory-programmed function	Remarks
18	HS_DET	18	Headset Detection	Only pin 18 can be configured for headset detection functionality
20	GPIO1	20	Pad disabled	
21	GPIO2	21	GNSS supply enable	
23	GPIO3	23	GNSS Data Ready	Only pin 23 can be configured for GNSS Data Ready functionality
24	GPIO4	24	GNSS RTC sharing	Only pin 24 can be configured for GNSS RTC sharing functionality

Table 18: LEON-G series GPIO mapping

<gpio_id>	Pin name	Pin number	Factory-programmed function	Remarks
16	GPIO1	16	Pad disabled	
23	GPIO2	23	GNSS supply enable	
24	GPIO3	24	GNSS Data Ready	Only pin 24 can be configured for GNSS Data Ready functionality

<gpio_id>	Pin name	Pin number	Factory-programmed function	Remarks
25	GPIO4	25	GNSS RTC sharing	Only pin 25 can be configured for GNSS RTC sharing functionality

Table 19: SARA-G350 / SARA-G340 GPIO mapping

<gpio_id>	Pin name	Pin number	Factory-programmed function	Remarks
20	GPIO1	20	Pad disabled	
21	GPIO2	21	GNSS supply enable	
23	GPIO3	23	GNSS Data Ready	Only pin 23 can be configured for GNSS Data Ready functionality
24	GPIO4	24	GNSS RTC sharing	Only pin 24 can be configured for GNSS RTC sharing functionality
51	GPIO5	51	SIM Card Detection	Only pin 51 can be configured for SIM card detection functionality

Table 20: LISA-U1 series GPIO mapping

<gpio_id>	Pin name	Pin number	Factory-programmed function	Remarks
20	GPIO1	20	Pad disabled	
21	GPIO2	21	Pad disabled	
23	GPIO3	23	Pad disabled	
24	GPIO4	24	Pad disabled	
51	GPIO5	51	SIM Card Detection	Only pin 51 can be configured for SIM card detection functionality
39	GPIO6	39	Pad disabled	
40	GPIO7	40	Pad disabled	
53	GPIO8	53	Pad disabled	
54	GPIO9	54	Pad disabled	

Table 21: LISA-U200-00S GPIO mapping





<gpio_id>	Pin name	Pin number	Factory-programmed function	Remarks
20	GPIO1	20	Pad disabled	
21	GPIO2	21	GNSS supply enable	
23	GPIO3	23	GNSS Data Ready	Only pin 23 can be configured for GNSS Data Ready functionality
24	GPIO4	24	GNSS RTC sharing	Only pin 24 can be configured for GNSS RTC sharing functionality
51	GPIO5	51	SIM Card Detection	Only pin 51 can be configured for SIM card detection functionality
39	GPIO6	39	2nd I ² S receive data input	Only pin 39 can be configured for 2nd I ² S receive data input functionality
40	GPIO7	40	2nd I ² S transmit data output	Only pin 40 can be configured for 2nd I ² S transmit data output functionality
53	GPIO8	53	2nd I ² S clock input/output	Only pin 53 can be configured for 2nd I ² S clock input/output functionality
54	GPIO9	54	2nd I ² S word alignment input/output	Only pin 54 can be configured for 2nd I ² S word alignment input/output functionality
55	GPIO10	55	SPI Serial Clock Input	Only pin 55 can be configured for SPI Serial Clock Input functionality
56	GPIO11	56	SPI Data Line Input	Only pin 56 can be configured for SPI Data Line Input functionality
57	GPIO12	57	SPI Data Line Output	Only pin 57 can be configured for SPI Data Line Output functionality
58	GPIO13	58	SPI Slave Ready Output	Only pin 58 can be configured for SPI Slave Ready Output functionality

<gpio_id>	Pin name	Pin number	Factory-programmed function	Remarks
59	GPIO14	59	SPI Master Ready Input	Only pin 59 can be configured for SPI Master Ready Input functionality

Table 22: LISA-U2 series (except LISA-U200-00S) GPIO mapping

<gpio_id>	Pin name	Pin number	Factory-programmed function	Remarks
16	GPIO1	16	Pad disabled	
23	GPIO2	23	GNSS supply enable	
24	GPIO3	24	GNSS Data Ready	Only pin 24 can be configured for GNSS Data Ready functionality
25	GPIO4	25	GNSS RTC sharing	Only pin 25 can be configured for GNSS RTC sharing functionality
42	GPIO5	42	SIM Card Detection	Only pin 42 can be configured for SIM card detection functionality
37	GPIO6	37	I ² S receive data input	Only pin 37 can be configured for I ² S receive data input functionality
35	GPIO7	35	I ² S transmit data output	Only pin 35 can be configured for I ² S transmit data output functionality
36	GPIO8	36	I ² S clock input/output	Only pin 36 can be configured for I ² S clock input/output functionality
34	GPIO9	34	I ² S word alignment input/output	Only pin 34 can be configured for I ² S word alignment input/output functionality

Table 23: SARA-U GPIO mapping

-  The "GNSS supply enable", "GNSS data ready" and "GNSS RTC sharing" custom functions can be handled by the **+UGPS** and the **+UGPRF** custom AT commands to manage the u-blox GNSS receiver connected to the cellular module and the embedded GPS aiding.
-  The AT+UGPIOC=xx,255 or AT+UGPIOC=xx,0 or AT+UGPIOC=xx,1 commands (where xx= 55, 56, 57, 58, 59) cannot be sent over SPI channel (the error message "+CME ERROR: GPIO busy" is reported). This is because these commands disable the SPI channel.
-  When the GPIOs 10-14 need to be switched from tristate (<gpio_mode>=255) or GPIO output (<gpio_mode>=0) or GPIO input (<gpio_mode>=1) to SPI functionality (<gpio_mode>=13), a power cycle (reset) is required for the changes to take effect.
-  When SIM card detection functionality is enabled, the status is reported by **+CIND** AT command.
-  See the corresponding module System Integration Manual for the complete overview of all allowed configurations.

19.1.3 Network status indication

When a GPIO pin is configured to provide network status indication, its progress depends on the CS network registration state (see **+CREG**) and on the module transmission state:

- No Service: indicates no network coverage or not registered state
- Registered home network 2G: indicates registered state on home network in 2G RAT
- Registered home network 3G: indicates registered state on home network in 3G RAT
- Registered roaming 2G: indicates registered state with visitor 2G network (roaming in 2G RAT)
- Registered roaming 3G: indicates registered state with visitor 3G network (roaming in 3G RAT)
- Data transmission: indicates voice or data call active either in 2G or 3G RAT



SARA-U

If the module is in CG class, the PS network registration state determines the network status indication; otherwise the GPIO pin progress depends on the CS network registration state.

The following figures report the allowed progresses for GPIO pin set as network indication: V_H and V_L values are provided in the corresponding module Data Sheet in the "Generic Digital Interfaces pins" section.

19.1.3.1 No service (no network coverage or not registered)

- Continuous Output / Low



19.1.3.2 Registered home network 2G

- Cyclic Output / High for 100 ms, Output / Low for 2 s

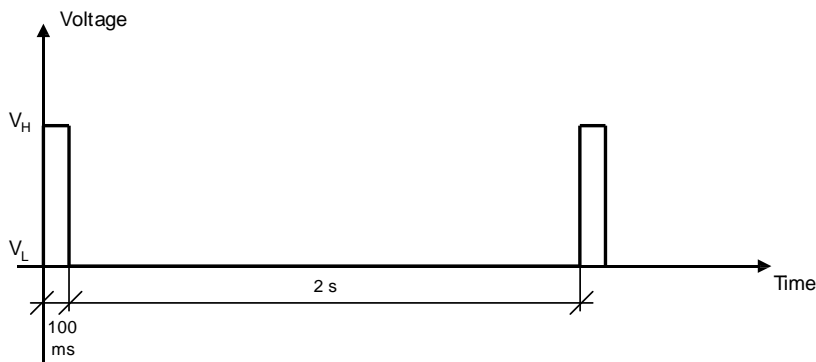

19.1.3.3 Registered home network 3G

- Cyclic Output / High for 50 ms, Output / Low for 50 ms, Output / High for 50 ms, Output / Low for 2 s

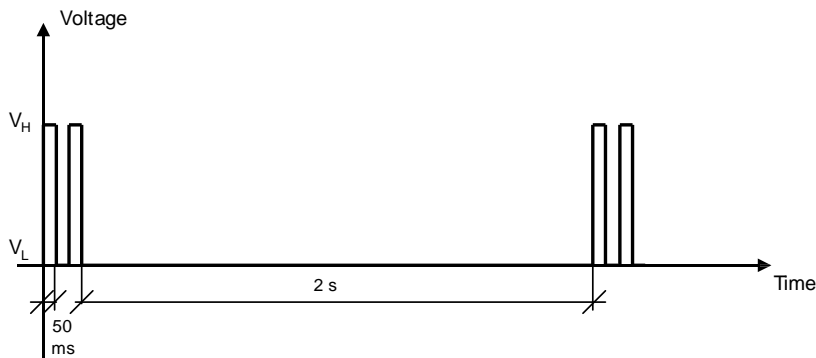

19.1.3.4 Registered roaming 2G

- Cyclic Output / High for 100 ms, Output / Low for 100 ms, Output / High for 100 ms, Output / Low for 2 s

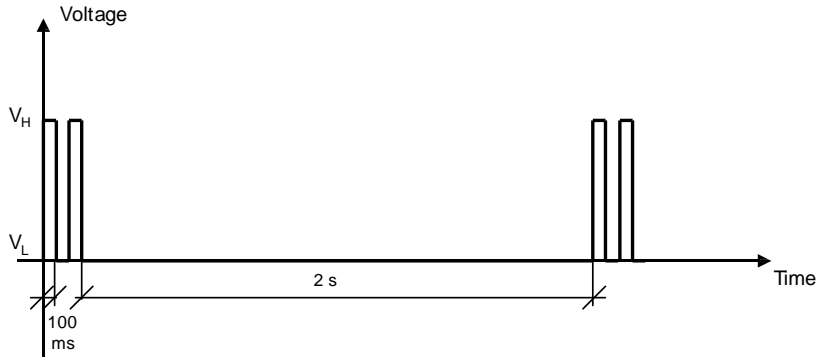

19.1.3.5 Registered roaming 3G

- Cyclic Output / High for 50 ms, Output / Low for 50 ms, Output / High for 50 ms, Output / Low for 100 ms

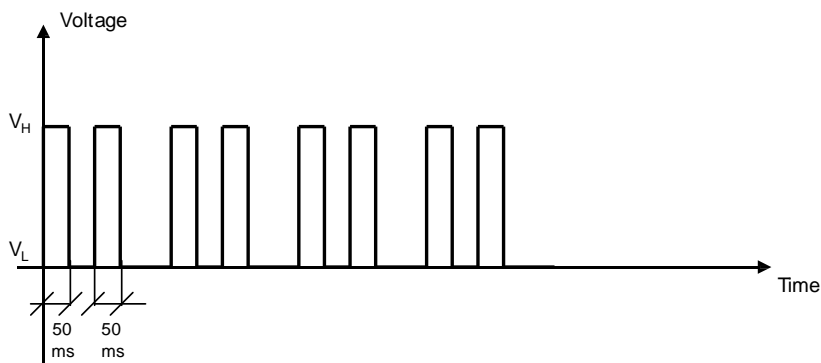

19.1.3.6 Data transmission

- Continuous Output / High

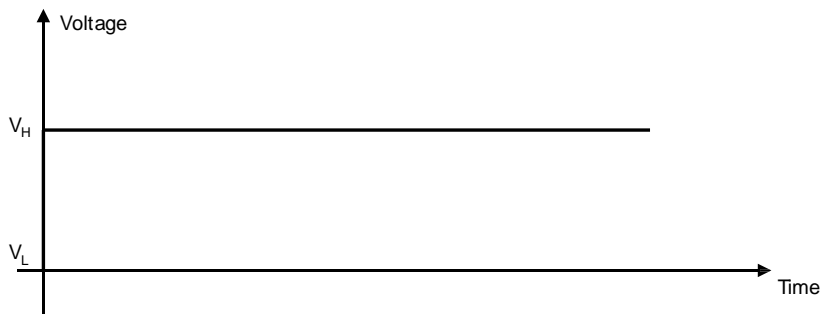

19.2 GPIO select configuration command +UGPIOC

+UGPIOC						
Modules	LEON-G SARA-G340 SARA-G350 LISA-U SARA-U					
Attributes	Syntax	PIN required	Settings saved	Can be aborted	Response time	Error reference
	partial	No	<i>NVM</i>	No	< 10 s	+CME Error

19.2.1 Description

Configures the GPIOs pins as input, output or to handle a custom function. When the GPIOs pins are configured as output pin, it is possible to set the value.

The test command provides the list of the supported GPIOs, the supported functions and the status of all the GPIOs.



Not all the GPIO functions can be assigned to each GPIO pin. If the configuration is not allowed, an error message will be returned (error code 1502 - "+CME ERROR: Select GPIO mode error").

The following custom functions cannot be simultaneously configured on 2 GPIOs.

- Network status indication
- GPS supply enable
- GPS data ready
- GPS RTC sharing
- SIM card detection
- Headset detection
- GSM Tx burst indication
- Module operating status indication
- Module functionality status indication



The AT+UGPIOC=xx,255 or AT+UGPIOC=xx,0 or AT+UGPIOC=xx,1 commands (where xx= 55, 56, 57, 58, 59) cannot be sent over the SPI interface (the error message "+CME ERROR: GPIO busy" is reported). This is because these commands disable the SPI interface.



To make available the GPIO set as "GPS supply enable" mode it is needed to stop supplying GPS with the *AT+UGPS=0* command.



For more details regarding the custom functions supported by the u-blox cellular modules and the factory-programmed settings, see [Chapter 19.1.1](#) and [Chapter 19.1.2](#).

19.2.2 Syntax

Type	Syntax	Response	Example
Set	AT+UGPIOC=<gpio_id>,<gpio_mode>[,<gpio_out_val>\<gpio_in_pull>]	OK	AT+UGPIOC=20,0,1 OK
Read	AT+UGPIOC?	+UGPIOC: <gpio_id>,<gpio_mode> [<gpio_id>,<gpio_mode> [...]] OK	+UGPIOC: 20,0 21,3 23,255 24,255 51,7 OK
Test	AT+UGPIOC=?	+UGPIOC: (list of supported GPIOs pins), (list of supported <gpio_mode>),(list of supported <gpio_out_val>\<gpio_in_pull>) [<gpio_id1>,<gpio_mode>	+UGPIOC: (20,21,23,24,51),(0-5,7,9,255),(0-2)

Type	Syntax	Response	Example
		...	
		<gpio_idN>,<gpio_mode>]	
		OK	

19.2.3 Defined values

Parameter	Type	Description
<gpio_id>	Number	GPIO pin identifier: pin number See the Chapter 19.1.2 for the available GPIO pins, their mapping and factory-programmed values on different u-blox cellular modules series and version.
<gpio_mode>	Number	Mode identifier: configured function See the Chapter 19.1.1 for custom functions supported by different u-blox cellular modules series and version. Allowed values: <ul style="list-style-type: none"> • 0: output • 1: input • 2: network status indication • 3: GPS supply enable • 4: GPS data ready • 5: GPS RTC sharing • 7: SIM card detection • 8: headset detection • 9: GSM Tx burst indication • 10: module operating status indication • 11: module functionality status indication • 12: I²S digital audio interface • 13: SPI serial interface • 255: pad disabled
<gpio_out_val>	Number	GPIO output value (for output function <gpio_mode>=0 only): <ul style="list-style-type: none"> • 0 (default value): low • 1: high
<gpio_in_pull>	Number	GPIO input value (for input function <gpio_mode>=1 only): <ul style="list-style-type: none"> • 0 (default value): no resistor activated • 1: pull up resistor active • 2: pull down resistor active

19.2.4 Notes

LISA-U1

- <gpio_in_pull> is not supported. It is pulled none by default for input function <gpio_mode>=1.
- the list of the <gpio_id> with the related <gpio_mode> is not provided in the test command.

LISA-U2

- GPIO6- GPIO9 pins can be configured as I2S1 digital interface. If not all these pins are set in "I2S digital audio interface" mode, the **+USPM** command attempting to switch the audio path on I2S1 will return a "+CME ERROR: operation not allowed" message. On the other side, if the audio path is already set as I2S1 by **+USPM** command, the **+UGPIOC** command trying to reconfigure the GPIO mode on any the I2S1 pins, will return a "+CME ERROR: GPIO busy" message.

SARA-U

- GPIO6- GPIO9 pins can be configured as I2S digital interface. If not all these pins are set in "I2S digital audio interface" mode, the **+USPM** command attempting to switch the audio path on I2S will return a "+CME ERROR: operation not allowed" message. On the other side, if the audio path is already set as I2S by **+USPM** command, the **+UGPIOC** command trying to reconfigure the GPIO mode on any of the I2S pins, will return a "+CME ERROR: GPIO busy" message. By default the audio path is I2S, to use I2S



pins as GPIO, the I2S interface must be disabled setting audio path to 'Null' path by command [+USPM](#) command.

SARA-G340 / SARA-G350

- the list of the `<gpio_id>` with the related `<gpio_mode>` is not provided in the test command.

LEON-G

- `<gpio_in_pull>` is not supported. It is pulled none by default for input function `<gpio_mode>=1`.
- the read command is not supported.

19.3 GPIO read command +UGPIOR

+UGPIOR						
Modules	LEON-G SARA-G340 SARA-G350					
	LISA-U SARA-U					
Attributes	Syntax	PIN required	Settings saved	Can be aborted	Response time	Error reference
	full	No	No	No	< 10 s	+CME Error

19.3.1 Description

Reads the current value of the specified GPIO, no matter whether it is configured as input or output (refer to [+UGPIOC](#) AT command to define the GPIO function). The syntax and the parameters range is shown in the response to the test command.

19.3.2 Syntax

Type	Syntax	Response	Example
Set	AT+UGPIOR=<gpio_id>	+UGPIOR: <gpio_id>,<gpio_val> OK	AT+UGPIOR=20 +UGPIOR: 20,0 OK
Test	AT+UGPIOR=?	+UGPIOR: (list of supported <gpio_id>s) OK	+UGPIOR: (20, 21) OK

19.3.3 Defined values

Parameter	Type	Description
<gpio_id>	Number	GPIO pin identifier: pin number Refer to Chapter 19.1.2 for the available GPIO pins, their mapping and factory-programmed values on different u-blox cellular modules series and version.
<gpio_val>	Number	GPIO value (0-1)

19.3.4 Notes

- The command works only if the parameter `<gpio_mode>` of the [+UGPIOC](#) AT command is set to 0 or 1.

19.4 GPIO set command +UGPIOW

+UGPIOW						
Modules	LEON-G SARA-G340 SARA-G350					
	LISA-U SARA-U					
Attributes	Syntax	PIN required	Settings saved	Can be aborted	Response time	Error reference
	full	No	No	No	< 10 s	+CME Error

19.4.1 Description

Sets ("writes") the output of the specified GPIO, but only if it is configured in output function (refer to [+UGPIOC](#) AT command to set the pin as output).



19.4.2 Syntax

Type	Syntax	Response	Example
Set	AT+UGPIOW=<gpio_id>,<gpio_out_val>	OK	AT+UGPIOW=20,1 OK
Test	AT+UGPIOW=?	+UGPIOW: (list of supported & <gpio_id>s), (list of supported <gpio_out_val>) OK	+UGPIOW: (20, 21),(0-1) OK

19.4.3 Defined values

Parameter	Type	Description
<gpio_id>	Number	GPIO pin identifier: pin number Refer to Chapter 19.1.2 for the available GPIO pins, their mapping and factory-programmed values on different u-blox cellular modules series and version.
<gpio_out_val>	Number	GPIO value (0-1)

19.4.4 Notes

- The command works only if the parameter <gpio_mode> of the [+UGPIOC](#) AT command is set to 0.

20. File System

20.1 Download file +UDWNFILE

+UDWNFILE						
Modules	LEON-G SARA-G340 SARA-G350 LISA-U SARA-U					
Attributes	Syntax	PIN required	Settings saved	Can be aborted	Response time	Error reference
	full	No	No	No	-	+CME Error

20.1.1 Description

Stores (writes) a file into the file system. The available free memory space is checked before starting the file transfer. If the file size exceeds the available space an error message is returned. If the data transfer stops, after 20 s the command is stopped and an error message is returned. If the module shuts down during file storing, all bytes of the file will be deleted.

No interrogation (test) is possible for this command. In case of any error, the return code will always be 100 ("unknown") or 4 ("ERROR"). If an error occurs during the file writing, the transfer is aborted and it is up to the user to delete the file.

 The maximal speed of the serial port is 115200 b/s.

 The serial port flow control must be enabled.

 The available user space in the file system can be retrieved using the command AT+ULSTFILE=1.

20.1.2 Syntax

Type	Syntax	Response	Example
Set	AT+UDWNFILE=<filename>, <size>	> Start transfer of file data OK	AT+UDWNFILE="filename",36 >The 36 downloaded bytes of the file! OK

20.1.3 Defined values

Parameter	Type	Description
<filename>	String	File name (max. 47 characters)
<size>	Number	File size expressed in bytes. On LISA-U1 / LISA-U2 series modules the range is from 0 to 2147483647 (i.e. 0x0 to 0x7fffffff)

20.1.4 Notes

- The stream of bytes can be entered after the '>' prompt has been provided to the user. The file transfer is terminated exactly when <size> bytes have been sent entered and either OK or an error message is returned. The feed process cannot be interrupted i.e. command mode is re-entered once the user has provided the declared the number of bytes.

LISA-U1

- Filesystem maximum file size: 1458176 bytes
- If the file already exists the incoming bytes will not be appended.
- If the module shuts down during file storing, all the bytes successfully sent to the module will be stored.

LISA-U2x0-01S / LISA-U200-00S

- If the file already exists the incoming bytes will not be appended.

LISA-U2 / SARA-U

- Filesystem maximum file size: 5242880 bytes

LEON-G / SARA-G

- Filesystem maximum file size: 1048575 bytes

20.2 Delete file +UDELFIELD

+UDELFIELD						
Modules	LEON-G SARA-G340 SARA-G350					
	LISA-U SARA-U					
Attributes	Syntax	PIN required	Settings saved	Can be aborted	Response time	Error reference
	full	No	No	No	-	+CME Error

20.2.1 Description

Deletes a stored file from the file system.



If <filename> file is not stored in the file system the following error message will be provided: "+CME ERROR: FILENOT FOUND".

20.2.2 Syntax

Type	Syntax	Response	Example
Set	AT+UDELFIELD=<filename>	OK	AT+UDELFIELD="filename" OK

20.2.3 Defined values

Parameter	Type	Description
<filename>	String	file name (max. 47 characters)

20.2.4 Notes

LEON-G / SARA-G350 / SARA-G340

- The command immediately returns OK but the actual erasing is completed in the background, and the freed space is not immediately available.

20.3 Read file +URDFIELD

+URDFIELD						
Modules	LEON-G SARA-G340 SARA-G350					
	LISA-U SARA-U					
Attributes	Syntax	PIN required	Settings saved	Can be aborted	Response time	Error reference
	full	No	No	No	-	-

20.3.1 Description

Retrieves a file from the file system.

20.3.2 Syntax

Type	Syntax	Response	Example
Set	AT+URDFIELD=<filename>	+URDFIELD: <filename>,<size>,<data> OK	AT+URDFIELD="filename" +URDFIELD: "filename",36,"these bytes are the data of the file" OK

20.3.3 Defined values

Parameter	Type	Description
<filename>	String	File name (max. 47 characters)
<size>	Number	File size, in bytes
<data>	Byte Stream	File Content

20.3.4 Notes

- The returned file data is displayed as an ASCII string of <length> characters in the range [0x00,0xFF]. At the end of the string, <CR><LF> are provided for user convenience and visualization purposes.
- The response contains the filename in string format.

LEON-G

- the filename is not enclosed within double quotes.

20.4 List files information +ULSTFILE

+ULSTFILE						
Modules	LEON-G SARA-G340 SARA-G350 LISA-U SARA-U					
Attributes	Syntax	PIN required	Settings saved	Can be aborted	Response time	Error reference
	full	No	No	No	-	+CME Error

20.4.1 Description

Retrieves the information about the FS. Depending on the specified <param_id>, it can print:

- List of files stored into the FS
- Remaining free FS space expressed in bytes
- Size of the specified file expressed in bytes



The available free space on FFS in bytes reported by the command AT+ULSTFILE=1 is the theoretical free space including the space occupied by the hidden and temporary files which are not displayed by the AT+ULSTFILE=0.

20.4.2 Syntax

Type	Syntax	Response	Example
Set	AT+ULSTFILE=[<param_id>[,<filename>]]	+ULSTFILE: [<filename1>[,<filename2>[, ...[,<filenameN>]]]] OK Or +ULSTFILE: <free_fs_space> OK Or +ULSTFILE: <file_size> OK	AT+ULSTFILE= +ULSTFILE: "filename" OK AT+ULSTFILE=1 +ULSTFILE: 236800 OK AT+ULSTFILE=2,"filename" +ULSTFILE: 784 OK

20.4.3 Defined values

Parameter	Type	Description
<param_id>	Integer	Possible values are: <ul style="list-style-type: none"> 0 (default value): list the files 1: get free space 2: get file size, <filename> parameter is required in this case
<free_fs_space>	integer	Available free space on FS in bytes
<file_size>	integer	Size of the file specified with param <filename> when <param_id> is 2

Parameter	Type	Description
<filenameX>	String	File name

20.4.4 Notes

- The maximum length of the file name is 47 characters.
- The theoretical maximum number of files also includes system, hidden and temporary files whose number is not statically predictable, so the actual number can be less than this.

LISA-U / SARA-U

- The maximum number of files that can be stored is 1100.

LEON-G / SARA-G340 / SARA-G350

- The theoretical maximum number of files that can be stored is 135.

20.5 Partial download file +URDBLOCK

+URDBLOCK						
Modules	LEON-G SARA-G340 SARA-G350					
	LISA-U200-02S LISA-U200-52S LISA-U200-62S LISA-U200-82S LISA-U260-02S LISA-U270-02S LISA-U270-62S SARA-U					
Attributes	Syntax	PIN required	Settings saved	Can be aborted	Response time	Error reference
	partial	No	No	No	-	+CME Error

20.5.1 Description

Retrieves a file from the file system.



Differently from [+URDFILE](#) command, this command allows the user to read only a portion of the file, indicating the offset and amount of bytes.

20.5.2 Syntax

Type	Syntax	Response	Example
Set	AT+URDBLOCK=<filename>,<offset>,<size>	+URDBLOCK: <filename>,<size>,<data> OK	AT+URDBLOCK="filename",0,20 +URDBLOCK: "filename",20,"these bytes are the " OK

20.5.3 Defined values

Parameter	Type	Description
<filename>	String	File name (the maximum length 47 characters)
<offset>	Number	Offset in bytes from the beginning of the file
<size>	Number	File size, in bytes
<data>	Byte Stream	Content of the file read

20.5.4 Notes

- The returned file data is displayed as an ASCII string of <length> characters in the range [0x00,0xFF]. At the end of the string, <CR><LF> are provided for user convenience and visualization purposes.
- In case a size larger than the whole file size is required the command returns the file size only, indicating the amount of bytes read.
- In case an offset larger than the whole file size is required, an ERROR message is triggered.

LEON-G / SARA-G

- The <filename> is not enclosed in double quotes in the information text response of the set command.

21. Audio interface

This section describes a set of u-blox proprietary AT commands to be used for the audio features configuration:

- **+USPM** command to set the audio path
- **+UI2S** command to configure I²S interfaces
- **+UPAR**, **+USAR**, **+UPLAYFILE**, **+USTOPFILE**, **+UTGN**, **+URNG**, **+UMSM** commands to manage players
- **+UMCLK**, **+UEXTDCONF** commands to manage external codec or other external audio IC
- **+UDCONF=30** command to configure allowed speech codecs

Audio parameters tuning section describes u-blox proprietary AT commands for the audio parameters tuning.

eCall section describes u-blox proprietary AT commands specific for eCall.

DTMF section describes u-blox proprietary AT commands specific for DTMF detection and generation.

Other standard commands available for audio configuration are listed as follows: **+CALM**, **+CRSL**, **+CLVL**, **+CMUT**, **+VTD**, **+VTS**, **+UVTS**.

The <silent> parameter in **+CALA** command refers to the alarm tone.

21.1 Audio path mode setting (Set Path Mode) +USPM

+USPM						
Modules	LEON-G SARA-G340 SARA-G350 LISA-U120 LISA-U130 LISA-U200-01S LISA-U200-02S LISA-U200-52S LISA-U200-62S LISA-U200-82S LISA-U230 LISA-U260 LISA-U270 SARA-U					
Attributes	Syntax	PIN required	Settings saved	Can be aborted	Response time	Error reference
	full	No	NVM	No	-	+CME Error

21.1.1 Description

Sets the audio path mode enabling the different audio paths (audio input and output) of the module for different use cases.

Besides the routing via analog or digital interface, the uplink and downlink paths include a set of the audio parameters (gains, digital filters, echo canceller parameters). The uplink paths can be configured through Microphone Gain Control (**+UMGC**), Uplink Biquad Filters (**+UUBF**), Hands-Free Parameters (**+UHFP**) AT commands.

The downlink paths can be configured through Speaker Gain Control (**+USGC**), Downlink Biquad Filters (**+UDBF**), Sidetone (**+USTN**) AT commands.

The command is used to choose the uplink and downlink path used.

Only one single uplink path and one single downlink path can be used. The parallel paths are not managed.

21.1.2 Syntax

Type	Syntax	Response	Example
Set	AT+USPM=<main_uplink>,<main_downlink>,<alert_sound>,<headset_indication>[,<vmic_ctrl>]	OK	AT+USPM=1,1,0,0 OK
Read	AT+USPM?	+USPM: <main_uplink>,<main_downlink>,<alert_sound>,<headset_indication>,<vmic_ctrl> OK	+USPM: 0,0,0,0,2 OK
Test	AT+USPM=?	+USPM: (list of supported <main_uplink>s),(list of supported <main_downlink>s),(list of supported <alert_sound>s),(list of supported <headset_	+USPM: (0-9,255),(0-9,255),(0),(0),(2) OK

Type	Syntax	Response	Example
		indication>s),(list of supported <vmic_ctrl>s) OK	

21.1.3 Defined values

Parameter	Type	Description
<main_uplink>	Number	Specifies the audio input path used for speech. See Notes for the allowed and default values.
<main_downlink>	Number	Specifies the audio output path used for speech. See Notes for the allowed and default values.
<alert_sound>	Number	Specifies if the alert sounds in idle mode are played on the main downlink path (same downlink path as speech; see <main_downlink> parameter) or on the loudspeaker: <ul style="list-style-type: none"> • 0: main downlink path • 1: loudspeaker See Notes for the allowed and default values.
<headset_indication>	Number	Specifies if the speech path is switched on the headset or not when the headset is inserted: <ul style="list-style-type: none"> • 0: the headset plug insertion is not indicated to the module; thus the module does not change automatically the speech audio path and leaves it as specified in <main_uplink>, <main_downlink> parameters • 1: the headset plug insertion is indicated to the module and thus the module automatically switch the speech audio path to headset mode (headset microphone for uplink and headset earpiece for downlink). The indication is carried by the rising edge of HS_DET signal, thus HS_DET pin should be connected to the audio headset connector. For more details about this connection see the corresponding module System Integration Manual. When the headset plug will be removed, an opposite falling edge will be generated and the module will automatically switch back to the main audio path (<main_uplink>, <main_downlink>). See Notes for allowed and default values.
<vmic_ctrl>	Number	Specifies the control mode for microphones voltage supply (VMIC). <ul style="list-style-type: none"> • 0: VMIC is synchronously switched on/off with the microphone amplifier; i.e. while the module is idle or is using I²S input line, microphone amplifiers and VMIC are switched off • 1: VMIC is switched always on • 2: VMIC is switched always off See Notes for allowed and default values.
<error>	String	If an incorrect number of parameters is provided or the parameter values are out of range the error message "+CME ERROR: operation not supported" will be provided if +CMEE is set to 2.

21.1.4 Notes

LEON-G1

- Allowed and default values for parameters:
 - o <main_uplink>
 - 0 (default value): handset microphone (pins: MIC_BIAS1, MIC_GND1)
 - 1: headset microphone (pins: MIC_BIAS2, MIC_GND2)
 - 2: I²S input line (pin I2S_RXD)
 - o <main_downlink>
 - 0 (default value): normal earpiece (pins: HS_P, GND)
 - 1: mono headset (pins: HS_P, GND)
 - 3: loudspeaker (pins: SPK_P, SPK_N)
 - 4: I²S output line (pin I2S_TXD)
 - o <alert_sound>
 - 0: alert sounds are played on main downlink path
 - 1 (default value): alert sounds are played on loudspeaker
 - o <headset_indication>
 - 0: headset indication is not considered
 - 1 (default value): headset indication is considered
 - o <vmic_ctrl>



- 0 (default value): VMIC is switched on/off
- 1: VMIC is always on
- 2: VMIC is always off
- The following table summarizes the allowed combination of parameters <main_uplink>, <main_downlink>, <alert_sound>, <headset_indication>:

Allowed values	Uplink	Downlink	Alert on	Headset indication
0, 0, 0, 1	Handset	Earpiece	Main path	Considered
0, 0, 1, 1	Handset	Earpiece	Loudspeaker	Considered
0, 0, 0, 0	Handset	Earpiece	Main path	Not considered
0, 0, 1, 0	Handset	Earpiece	Loudspeaker	Not considered
0, 3, 0, 0	Handset	Loudspeaker	Main path	Considered
0, 3, 0, 1	Handset	Loudspeaker	Main path	Not considered
0, 1, 0, 0	Handset	Mono headset	Main path	Not considered
1, 1, 0, 0	Handset	Mono headset	Main path	Not considered
1, 0, 0, 0	Handset	Earpiece	Main path	Not considered
1, 0, 1, 0	Handset	Earpiece	Loudspeaker	Not considered
1, 3, 0, 0	Handset	Loudspeaker	Main path	Not considered
2, 4, 0, 0	I ² S input	I ² S output	Main path	Not considered

SARA-G340 / SARA-G350

- Allowed and default values for parameters:
 - o <main_uplink>
 - 0 (default value): handset microphone (pins: MIC_P, MIC_N, MIC_BIAS, MIC_GND)
 - 1: headset microphone (pins: MIC_P, MIC_N, MIC_BIAS, MIC_GND)
 - 2: I²S input line (pin I2S_RXD)
 - 4: hands-free microphone (pins: MIC_P, MIC_N, MIC_BIAS, MIC_GND)
 - o <main_downlink>
 - 0 (default value): normal earpiece (pins: SPK_N, SPK_P)
 - 1: mono headset (pins: SPK_N, SPK_P)
 - 3: loudspeaker (pins: SPK_N, SPK_P)
 - 4: I²S output line (pin I2S_TXD)
 - o <alert_sound>
 - 0 (default value): alert sounds are played on the main downlink path
 - o <headset_indication>
 - 0 (default value): headset indication is not considered
 - o <vmic_ctrl>
 - 0 (default value): VMIC is switched on/off
 - 1: VMIC is always switched on
- The following table summarizes the allowed combination of parameters <main_uplink> and <main_downlink> (<alert_sound>, <headset_indication> must always be set to 0):

Uplink\Downlink	0 - Earpiece	1 - Mono headset	2 - Unused	3 - Loudspeaker	4 - I ² S output
0 - Handset	x	x		x	
1 - Headset	x	x		x	
2 - I ² S input					x
3 - Unused					
4 - Hands-free mic	x	x		x	

LISA-U1

- Allowed and default values for parameters:
 - o <main_uplink>
 - 0: (pins MIC_P, MIC_N)
 - 1 (default value): headset microphone (pins: MIC_P, MIC_N)



- 2: I²S input line (pin I2S_RXD)
- 4: hands-free microphone (pins: MIC_P, MIC_N)
- o **<main_downlink>**
 - 0: normal earpiece (pins: SPK_N, SPK_P)
 - 1 (default value): mono headset (pins: SPK_N, SPK_P)
 - 3: loudspeaker (pins: SPK_N, SPK_P)
 - 4: I²S output line (pin I2S_TXD)
- o **<alert_sound>**
 - 0 (default value): alert sounds are played on the main downlink path
- o **<headset_indication>**
 - 0 (default value): headset indication is not considered
- o **<vmic_ctrl>**
 - 2 (default value): VMIC is switched always off
- The following table summarizes the allowed combination of parameters <main_uplink> and <main_downlink> (<alert_sound>, <headset_indication> must always be set to 0):

Uplink\Downlink	0 - Earpiece	1 - Mono headset	2 - Unused	3 - Loudspeaker	4 - I ² S output
0 - Handset	x	x		x	
1 - Headset	x	x		x	
2 - I ² S input					x
3 - Unused					
4 - Hands-free mic	x	x		x	

LISA-U2

- Allowed and default values for parameters:
 - o **<main_uplink>**
 - 0: uplink path 0 via I2S
 - 1 (default value): uplink path 1 via I2S
 - 2: uplink path 2 via I2S
 - 3: uplink path 3 via I2S
 - 4: uplink path 4 via I2S
 - 5: uplink path 5 via I2S1
 - 6: uplink path 6 via I2S1
 - 7: uplink path 7 via I2S1
 - 8: uplink path 8 via I2S1
 - 9: uplink path 9 via I2S1
 - o **<main_downlink>**
 - 0: downlink path 0 via I2S
 - 1 (default value): downlink path 1 via I2S
 - 2: downlink path 2 via I2S
 - 3: downlink path 3 via I2S
 - 4: downlink path 4 via I2S
 - 5: downlink path 5 via I2S1
 - 6: downlink path 6 via I2S1
 - 7: downlink path 7 via I2S1
 - 8: downlink path 8 via I2S1
 - 9: downlink path 9 via I2S1
 - o **<alert_sound>**
 - 0 (default value): alert sounds are played on main downlink path
 - o **<headset_indication>**
 - 0 (default value): headset indication is not considered



- o **<vmic_ctrl>**
 - 2 (default value): VMIC is switched always off
- The **<main_uplink>** paths from 0 to 4 can be combined with the **<main_downlink>** paths from 0 to 4 (I2S is used).
- The **<main_uplink>** paths from 5 to 9 can be combined with the **<main_downlink>** paths from 5 to 9 (I2S1 is used).
- The I2S1 pins are the GPIO pins (GPIO6-GPIO9). If not all these pins are set to "I²S digital audio interface" mode (see the **AT+UGPIOC** command, **<gpio_mode>=12**), the command attempting to switch the audio path on I2S1 will return a "+CME ERROR: operation not allowed" message. On the other side, if the audio path is already set to I2S1 by the +USPM command, the +UGPIOC command trying to reconfigure the GPIO mode on any I2S1 pin, will return a "+CME ERROR: GPIO busy" message.

SARA-U

- Allowed and default values for parameters:
 - o **<main_uplink>**
 - 0: uplink path 0 via I2S
 - 1 (default value): uplink path 1 via I2S
 - 2: uplink path 2 via I2S
 - 3: uplink path 3 via I2S
 - 4: uplink path 4 via I2S
 - 255: null path ; no audio interface is enabled
 - o **<main_downlink>**
 - 0: downlink path 0 via I2S
 - 1 (default value): downlink path 1 via I2S
 - 2: downlink path 2 via I2S
 - 3: downlink path 3 via I2S
 - 4: downlink path 4 via I2S
 - 255: null path ; no audio interface is enabled
 - o **<alert_sound>**
 - 0 (default value): main downlink path
 - o **<headset_indication>**
 - 0 (default value): not considered
 - o **<vmic_ctrl>**
 - 2 (default value): VMIC is switched always off
- The uplink path from 0 to 4 can be combined with the **<main_downlink>** path from 0 to 4.
- The uplink path 255 (null path) can be combined only with the **<main_downlink>** path 255. This is the NULL path mode. In this audio path mode no audio path is never enabled and I2S pin can be reconfigured. Parameters **<alert_sound>**, **<headset_indication>** and **<vmic_ctrl>** are not considered in this mode.
- The I2S pin are the GPIO pins (GPIO6-GPIO9). If not all these pins are set in "I²S digital audio interface" mode (see the **AT+UGPIOC** command, **<gpio_mode>=12**), the +USPM command attempting to switch the audio path from NULL mode to I2S mode, will return a "+CME ERROR: operation not allowed" message. On the other side, if the audio path is already set as I2S by the +USPM command, the **+UGPIOC** command trying to reconfigure the GPIO mode on any I2S pin, will return a "+CME ERROR: GPIO busy" message. To configure GPIO6-GPIO9 in any mode different of "I2S digital audio interface", the +USPM command must previously switch the audio path in NULL path mode (**<main_uplink>=255, <main_downlink>=255**).

21.2 I²S digital interface mode +UI2S

+UI2S						
Modules	LEON-G SARA-G340 SARA-G350					
	LISA-U120 LISA-U130 LISA-U200-01S LISA-U200-02S LISA-U200-52S LISA-U200-62S LISA-U200-82S LISA-U230 LISA-U260 LISA-U270 SARA-U					
Attributes	Syntax	PIN required	Settings saved	Can be aborted	Response time	Error reference
	full	No	<i>NVM</i>	No	-	<i>+CME Error</i>

21.2.1 Description

Configures the I²S digital audio interface to be used when digital audio paths are chosen (*+USPM* command, `<main_uplink>=I2S RX`, `<main_downlink>=I2S TX`).

The I²S TX and RX data line can be connected to two different access points of the uplink and downlink audio path (see the module audio block diagram in the [Chapter 22.1](#)).

The digital audio interface is I2S.



LISA-U2

A second digital audio interface (I2S1) is also available.

I²S interface can be configured either in Master or in Slave mode (`<I2S_Master_Slave>` parameter):

- In master mode the module generates the WA (word alignment) and CLK (clock) signals
- In slave mode the remote device must generate the WA (word alignment) and CLK (clock) signals



LEON-G / SARA-G340 / SARA-G350

The slave mode is not supported.

The sample rate of transmitted and received words is configurable as 8, 11.025, 12, 16, 22.05, 24, 32, 44.1 and 48 kHz through `<I2S_sample_rate>` parameter.



LEON-G / SARA-G340 / SARA-G350

Only the sampling rate to 8 kHz is supported.

Furthermore synchronization between data, clock and word alignment lines can be configured in different modes through `<I2S_mode>` parameter:

- PCM modes (short synchronization signal)
- Normal I²S modes (long synchronization signal)

For details about I²S technical features in PCM and Normal I²S mode, see the corresponding module System integration Manual.

The physical I²S port is composed of 4 pins. The signals are:

- I2S_WA (Word Alignment): output signal in master mode, input signal in slave mode; it synchronizes the data word; the WA cycle frequency is `<I2S_sample_rate>`, while WA cycle timing depends on the mode (see [Chapter 21.2.5](#), [Chapter 21.2.6](#), [Chapter 21.2.7](#) and [Chapter 21.2.8](#))
- I2S_TXD (Transmitted Data): output signal; sequence of data bits, most significant bit transmitted first. Each word is 16 bits long, in 2's complement format with the configured I²S sample rate
- I2S_CLK (Clock): output signal in master mode, input signal in slave mode; it synchronizes the bits composing the data words; CLK frequency and edge synchronization with TXD/RXD signals depends on `<I2S_mode>` and the configured I²S sample rate. See [Chapter 21.2.5](#) and [Chapter 21.2.7](#)
- I2S_RXD (Received Data): input signal; sequence of data bits, most significant bit read first. Each word is 16 bits long, in 2's complement format with the configured I²S sample rate



LEON-G

the I²S pins are mapped in the following way:

- Pin 26: I2S_WA
- Pin 27: I2S_TXD
- Pin 28: I2S_CLK
- Pin 29: I2S_RXD



SARA-G340 / SARA-G350 / SARA-U260 / SARA-U270

The I²S pins are mapped in the following way:

- Pin 34: I2S_WA
- Pin 35: I2S_TXD
- Pin 36: I2S_CLK
- Pin 37: I2S_RXD



LISA-U120 / LISA-U130 / LISA-U2

The I²S pins of the first interface are mapped in the following way:

- Pin 41: I2S_WA
- Pin 42: I2S_TXD
- Pin 43: I2S_CLK
- Pin 44: I2S_RXD



LISA-U2

The I²S pins of the second interface are mapped in the following way:



- Pin 39: I2S1_RXD
- Pin 40: I2S1_TXD
- Pin 53: I2S1_CLK
- Pin 54: I2S1_WA

21.2.2 Syntax

Type	Syntax	Response	Example
Set	AT+UI2S=<I2S_mode>,<I2S_port>,<I2S_clk_wa>[,<I2S_sample_rate>[,<I2S_Master_Slave>]]	OK	AT+UI2S=10,1,1,5,1 OK
Read	AT+UI2S?	+UI2S: <I2S_mode>,<I2S_port>,<I2S_clk_wa>,<I2S_sample_rate>,<I2S_Master_Slave> (Repeated for all I ² S interfaces) OK	+UI2S: 4,1,1,4,1 +UI2S: 10,3,1,5,0 OK
Test	AT+UI2S=?	+UI2S: (list of supported <I2S_mode>s), (list of supported <I2S_port>s), (list of supported <I2S_clk_wa>)[,(list of supported <I2S_sample_rate>),(list of supported <I2S_Master_Slave>)] OK	+UI2S: (0-13),(1,3),(0-1),(0-8),(0-1) OK

21.2.3 Defined values

Parameter	Type	Description
<I2S_mode>	Number	Specifies I ² S configurable modes. The allowed values are (0-13) as described in Chapter 21.2.5 , Chapter 21.2.7 <ul style="list-style-type: none"> • Default value: 4 • PCM modes (short synchronization signal) and normal I²S modes (long synchronization signal) are available • See Chapter 21.2.5, Chapter 21.2.7 for modes available on each connection point and for their settings • See the Chapter 21.2.6 and Chapter 21.2.8 for the signals timing
<I2S_port>	Number	Specifies which I ² S physical port (I2S or I2S1) is used and where it is connected in the internal audio processing path (I2Sx or I2Sy connection points) when digital path is selected as audio path

Parameter	Type	Description
		<p>(see the <i>AT+USPM</i> command). I²S connections points positions are showed in the audio paths block diagram in <i>Chapter 22.1</i>. The allowed values are:</p> <ul style="list-style-type: none"> • 1: I2S is connected to I2Sx connection point • 2: I2S is connected to I2Sy connection point • 3: I2S1 is connected to I2Sx connection point • 4: I2S1 is connected to I2Sy connection point <ul style="list-style-type: none"> ◦ I2Sx connection point is parallel to the analog audio front end. In this case the digital audio path is comparable with the analog audio paths (see the <i>AT+USPM</i> command) ◦ I2Sy connection point is nearer to the codec in the audio path. While using this access point the audio path is not affected by some audio controls as digital filters (<i>+UUBF</i>, <i>+UDBF</i>), digital gains (<i>+UMGC</i>, <i>+USGC</i>), sidetone (<i>+USTN</i>); furthermore some audio resources as tone generator (<i>+UTGN</i>), info tones (e.g. free tone, connection tone, low battery alarm), players (ringer on incoming call, alarm and tunes generated by <i>+UPAR</i> command) are not available on I2Sy connection point <p> Volume control (<i>+CLVL</i>) and hands-free algorithm (<i>+UHFP</i>) are active for both connection points.</p> <p> The analog gains in the <i>+USGC</i> and <i>+UMGC</i> commands are unused for both connection points.</p>
<I2S_clk_wa>	Number	<p>Specifies when CLK and WA signal are active. The allowed values are:</p> <ul style="list-style-type: none"> • 0: Dynamic mode; CLK and WA outputs are active and only running when the audio path is active (audio samples are read on RX line and written on TX line). After the audio path is disabled (i.e. a call is hang up), CLK and WA are disabled too • 1: Continuous mode; CLK and WA outputs are always active and running if the <i>+USPM</i> current setting implies the <I2S_port> usage, even when the module is idle and the audio path is disabled (no audio data written on TX line, no audio data read on RX line). This implies the module cannot enter power saving mode
<I2S_sample_rate>	Number	<p>I²S sample rate (frame rate). This is the frequency of the word set and received by I²S interface. The words are synchronized by the WA (word alignment) signal. Thus <I2S_sample_rate> matches with the frequency of WA signal.</p> <p>The allowed values are:</p> <ul style="list-style-type: none"> • 0: 8 kHz sampling rate • 1: 11.025 kHz sampling rate • 2: 12 kHz sampling rate • 3: 16 kHz sampling rate • 4: 22.05 kHz sampling rate • 5: 24 kHz sampling rate • 6: 32 kHz sampling rate • 7: 44.1 kHz sampling rate • 8: 48 kHz sampling rate
<I2S_Master_Slave>	Number	<p>Indicates the Master/Slave mode of I²S interface</p> <p>The allowed values are:</p> <ul style="list-style-type: none"> • 0: master mode. CLK, WA, TX are output signals generated by the module. RX is an input signal • 1: slave mode. Only TX signal is an output signal generated by the module. CLK, WA, RX are input signals and must be generated by the remote device.

21.2.4 Notes

LISA-U1

- <I2S_port>=2, 3, 4 are not supported.
- If an incorrect number of parameters is provided or the parameter value is out of range the error message "+CME ERROR: operation not supported" will be provided if +CMEE is set to 2:
 - +UI2S command returns ERROR when the audio path is in digital mode (+USPM: 2,4,0,0). This is because the I²S settings cannot be changed when the audio path is configured to use this interface. It is necessary to disable the digital audio path switching to analog path (e.g.: by command AT +USPM=0,0,0,0; see the *+USPM* AT command), configure the I²S interface, and then re-select the digital path by command AT+USPM=2,4,0,0 (see the *+USPM* AT command).



- o +UI2S command returns ERROR if I²S pins are already allocated by another resource
- o +UI2S settings are saved in NVM after power off if changed
- The factory-programmed values are as follows:
 - o <I2S_mode>=0, <I2S_port>=1, <I2S_clk_wa>=0, <I2S_sample_rate>=0, <I2S_Master_Slave>=0

LISA-U2

- <I2S_port>=2, 4 are not supported.
- If an incorrect number of parameters is provided or the parameter value is out of range the error message "+CME ERROR: operation not supported" will be provided if +CMEE is set to 2:
 - o +UI2S command returns ERROR when the <I2S_port> specified is used by the current audio path (<I2S_port>=3; +USPM: 8,7,0,0). The I²S settings cannot be changed when the audio path is configured to use this interface. It is necessary to change the audio path by the +USPM AT command to a configuration not using the <I2S_port>, configure the <I2S_port> by +UI2S, and then re-select the +USPM mode using the <I2S_port> specified.
 - o +UI2S command returns ERROR if I²S pins are already allocated by another resource
 - o +UI2S settings are saved in NVM after power off if changed
- The factory-programmed values are as follows:
 - o I2S: <I2S_mode>=1, <I2S_port>=1, <I2S_clk_wa>=0, <I2S_sample_rate>=3, <I2S_Master_Slave>=0
 - o I2S1: <I2S_mode>=1, <I2S_port>=3, <I2S_clk_wa>=0, <I2S_sample_rate>=3, <I2S_Master_Slave>=0

SARA-U

- <I2S_port>=2, 3, 4 are not supported.
- If an incorrect number of parameters is provided or the parameter value is out of range the error message "+CME ERROR: operation not supported" will be provided if +CMEE is set to 2:
 - o +UI2S command returns ERROR when the audio path is in digital mode. This is because the I²S settings cannot be changed when the audio path is configured to use this interface. It is necessary to disable the digital audio path switching the audio path to NULL path mode (see the +USPM AT command), configure the I²S interface, and then re-select the digital path (see the +USPM AT command).
 - o +UI2S command returns ERROR if I²S pins are already allocated by another resource
 - o +UI2S settings are saved in NVM after power off if changed
- The factory-programmed values are as follows:
 - o <I2S_mode>=1, <I2S_port>=1, <I2S_clk_wa>=0, <I2S_sample_rate>=3, <I2S_Master_Slave>=0

SARA-G340 / SARA-G350

- The <I2S_sample_rate> and <I2S_Master_Slave> parameters are not supported.
- <I2S_port>=2, 3, 4 are not supported.
- If an incorrect number of parameters is provided or the parameter value is out of range the error message "+CME ERROR: operation not supported" will be provided if +CMEE is set to 2:
 - o +UI2S command returns ERROR when the audio path is in digital mode (+USPM: 2,4,0,0). This is because the I²S settings cannot be changed when the audio path is configured to use this interface. It is necessary to disable the digital audio path switching to analog path (e.g.: by command AT +USPM=0,0,0,0; see the +USPM AT command), configure the I²S interface, and then re-select the digital path by command AT+USPM=2,4,0,0 (see the +USPM AT command).
 - o +UI2S command returns ERROR if I²S pins are already allocated by another resource
 - o +UI2S settings are saved in NVM after power off if changed
- The factory-programmed values are as follows:
 - o <I2S_mode>=1, <I2S_port>=1, <I2S_clk_wa>=0

LEON-G

- <I2S_port>=3, 4 are not supported.
- The <I2S_sample_rate> and <I2S_Master_Slave> parameters are not supported.

- If an incorrect number of parameters is provided or the parameter value is out of range the error message "+CME ERROR: operation not supported" will be provided if +CMEE is set to 2:
 - +UI2S command returns ERROR when the audio path is in digital mode (+USPM: 2,4,0,0). This is because the I²S settings cannot be changed when the audio path is configured to use this interface. It is necessary to disable the digital audio path switching to analog path (e.g.: by command AT +USPM=0,0,0,0; see the +USPM AT command), configure the I²S interface, and then re-select the digital path by command AT+USPM=2,4,0,0 (see the +USPM AT command)
 - +UI2S command returns ERROR if I²S pins are already allocated by another resource
 - +UI2S settings are saved in NVM after power off if changed
- The factory-programmed values are as follows:
 - <I2S_mode>=4, <I2S_port>=2, <I2S_clk_wa>=1
- [Table 24](#), [Table 25](#), [Table 26](#) and [Table 27](#) sections describe the allowed combinations of <I2S_mode> and <I2S_port>

	PCM modes	Normal I ² S modes
I2Sx connection of I2S	(0-1)	Not supported
I2Sy connection of I2S	Not supported	(2-13)
I2Sx connection of I2S1	Not supported	Not supported
I2Sy connection of I2S1	Not supported	Not supported

Table 24: LEON-G series I²S modes

	PCM modes	Normal I ² S modes
I2Sx connection of I2S	(0-1)	(2-13)
I2Sy connection of I2S	Not supported	Not supported
I2Sx connection of I2S1	Not supported	Not supported
I2Sy connection of I2S1	Not supported	Not supported

Table 25: SARA-G series I²S modes

	PCM modes	Normal I ² S modes
I2Sx connection of I2S	(0-1)	(2-13)
I2Sy connection of I2S	Not supported	Not supported
I2Sx connection of I2S1	Not supported	Not supported
I2Sy connection of I2S1	Not supported	Not supported

Table 26: LISA-U1 / SARA-U series I²S modes

<I2S_port>	PCM modes	Normal I ² S modes
I2Sx connection of I2S	(0-1)	(2-13)
I2Sy connection of I2S	Not supported	Not supported
I2Sx connection of I2S1	(0-1)	(2-13)
I2Sy connection of I2S1	Not supported	Not supported

Table 27: LISA-U2 series I²S modes

21.2.5 PCM modes (short synchronization signal)

Mode	CLK EDGE for TX	CLK EDGE for RX	WA pulse length	CLK frequency	WA frequency
0	RISING	FALLING	2 clks	18* <I2S_sample_rate>	<I2S_sample_rate>
1	RISING	FALLING	1 clk	17* <I2S_sample_rate>	<I2S_sample_rate>

21.2.6 PCM modes timing diagrams

WA (PCM mode 0): pulse is 2 bits wide; 18 clocks / WA cycle

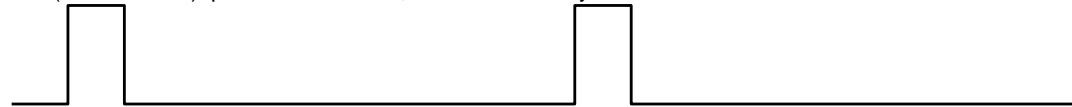

TXD (PCM mode 0): After synchronization bit (0), MSB is transmitted twice and Word is aligned on WA falling edge

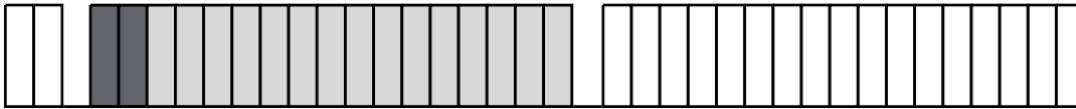

WA (PCM mode 1): pulse is 1 bits wide; 17 clocks / WA cycle



TXD (PCM mode 1): After synchronization bit (0), word is aligned on WA falling edge

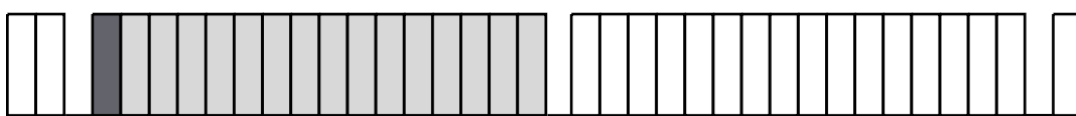

A single transmitted word is marked in grey. MSB is marked darker.

Since RXD bits are read on the falling edge of CLK signal, the RXD word slot starts half bit delayed respect TXD word slot.

Relation between WA and CLK edge for PCM mode is:

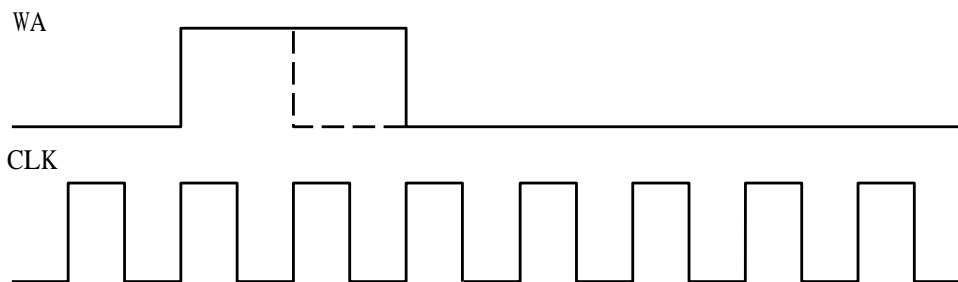

21.2.7 Normal I²S modes (long synchronization signal)

Mode	CLK edge for TX	CLK edge for RX	MSB delay	TX channel	RX channel	CLK frequency	WA frequency
2	FALLING	RISING	1 bit	WA LOW	WA LOW	32* $\langle I2S_sample_rate \rangle$	$\langle I2S_sample_rate \rangle$
3	RISING	FALLING	1 bit	WA LOW	WA LOW	32* $\langle I2S_sample_rate \rangle$	$\langle I2S_sample_rate \rangle$
4	FALLING	RISING	0 bit	WA LOW	WA LOW	32* $\langle I2S_sample_rate \rangle$	$\langle I2S_sample_rate \rangle$
5	RISING	FALLING	0 bit	WA LOW	WA LOW	32* $\langle I2S_sample_rate \rangle$	$\langle I2S_sample_rate \rangle$
6	FALLING	RISING	1 bit	WA HIGH	WA HIGH	32* $\langle I2S_sample_rate \rangle$	$\langle I2S_sample_rate \rangle$
7	RISING	FALLING	1 bit	WA HIGH	WA HIGH	32* $\langle I2S_sample_rate \rangle$	$\langle I2S_sample_rate \rangle$
8	FALLING	RISING	0 bit	WA HIGH	WA HIGH	32* $\langle I2S_sample_rate \rangle$	$\langle I2S_sample_rate \rangle$
9	RISING	FALLING	0 bit	WA HIGH	WA HIGH	32* $\langle I2S_sample_rate \rangle$	$\langle I2S_sample_rate \rangle$
10	FALLING	RISING	1 bit	WA HIGH & LOW	WA HIGH	32* $\langle I2S_sample_rate \rangle$	$\langle I2S_sample_rate \rangle$
11	RISING	FALLING	1 bit	WA HIGH & LOW	WA HIGH	32* $\langle I2S_sample_rate \rangle$	$\langle I2S_sample_rate \rangle$
12	FALLING	RISING	0 bit	WA HIGH & LOW	WA HIGH	32* $\langle I2S_sample_rate \rangle$	$\langle I2S_sample_rate \rangle$



Mode	CLK edge for TX	CLK edge for RX	MSB delay	TX channel	RX channel	CLK frequency	WA frequency
13	RISING	FALLING	0 bit	WA HIGH & LOW	WA HIGH	32* \langle I2S_sample_rate \rangle	\langle I2S_sample_rate \rangle

21.2.8 Normal I²S modes timing diagrams

WA (all normal modes)



TXD timeslot (Normal mode 2-3): 1 bit delay; channel on WA low



TXD timeslot (Normal mode 4-5): 0 bit delay; channel on WA low



TXD (Normal mode 6-7): 1 bit delay; channel on WA high

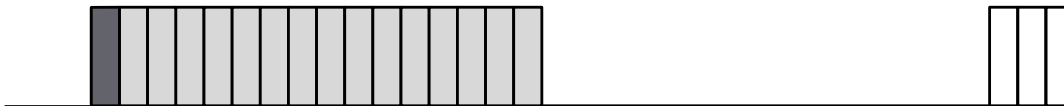

TXD (Normal mode 8-9): 0 bit delay; channel on WA high

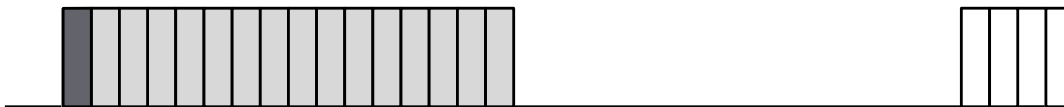

TXD (Normal mode 10-11): 1 bit delay; channel on WA high and low



TXD (Normal mode 12-13): 0 bit delay; channel on WA high and low



A single transmitted word is marked in grey. MSB is marked darker.

Since RXD bits are read on the opposite edge of CLK signal respect TXD bits, the RXD word slot starts half bit delayed respect TXD word slot.

Relation between WA and CLK edge for Normal I²S depends on mode:

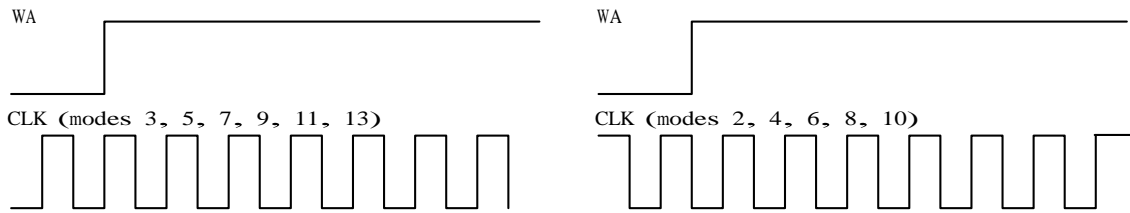

21.3 Play audio resource (Play Audio Resource) +UPAR

+UPAR						
Modules	LEON-G SARA-G340 SARA-G350 LISA-U120 LISA-U130 LISA-U200-01S LISA-U200-02S LISA-U200-52S LISA-U200-62S LISA-U200-82S LISA-U230 LISA-U260 LISA-U270 SARA-U					
Attributes	Syntax	PIN required	Settings saved	Can be aborted	Response time	Error reference
	partial	No	No	No	-	+CME Error

21.3.1 Description

Starts the playback of the pre-defined tone of the selected audio resource.

21.3.2 Syntax

Type	Syntax	Response	Example
Set	AT+UPAR=<audio_resource>,<tone_id>,<nof_repeats>	OK	AT+UPAR=0,1,0 OK
Test	AT+UPAR=?	+UPAR: (list of supported <audio_resource>s),(list of supported <tone_id>s),(list of supported <nof_repeats>s) OK	+UPAR: (0-2),(0-66),(0-255) OK

21.3.3 Defined values

Parameter	Type	Description
<audio_resource>	Number	Specifies the audio resource <ul style="list-style-type: none"> 0: tone generator 1: MIDI player 2: audio loop for test purposes. Use this command to generate an audio loop between the uplink and downlink current path (+USPM) when not in a call. Use the sidetone command (+USTN) for the loop amount configuration. For the uplink to downlink loop on call use sidetone (+USTN) command only
<tone_id>	Number	Specifies the pre-defined tone id to be played; the supported values depend by <audio_resource> values according to the tables reported below
<nof_repeats>	Number	Specifies the number of repeats <ul style="list-style-type: none"> 0: infinite loop n: n repeats
<error>	Number	If an incorrect number of parameters is provided or the parameter values are out of range the error result code "+CME ERROR: operation not supported" will be provided if +CME is set to 2

Allowed values for tone generator are:

Id	Tone	Id	Tone	Id	Tone
0	DTMF 0	23	service tone 6	46	melody 0
1	DTMF 1	24	service tone 7	47	melody 1
2	DTMF 2	25	service tone 8	48	melody 2
3	DTMF 3	26	service tone 9	49	melody 3
4	DTMF 4	27	service tone 10	50	melody 4
5	DTMF 5	28	service tone 11	51	melody 5
6	DTMF 6	29	service tone 12	52	melody 6

Id	Tone	Id	Tone	Id	Tone
7	DTMF 7	30	service tone 13	53	melody 7
8	DTMF 8	31	service tone 14	54	melody 8
9	DTMF 9	32	service tone 15	55	melody 9
10	DTMF hash	33	service tone 16	56	melody 10
11	DTMF asterix	34	service tone 17	57	melody 11
12	key tone 1	35	service tone 18	58	melody 12
13	key tone 2	36	service tone 19	59	melody 13
14	key tone 3	37	service tone 20	60	melody 14
15	key tone 4	38	service tone 21	61	melody 15
16	key tone 5	39	service tone 22	62	melody 16
17	service tone 0	40	service tone 23	63	melody 17
18	service tone 1	41	service tone 24	64	melody 18
19	service tone 2	42	service tone 25	65	service tone 29
20	service tone 3	43	service tone 26	66	service tone 30
21	service tone 4	44	service tone 27		
22	service tone 5	45	service tone 28		

Allowed values for <audio_resource>=1 (MIDI player) are:

21.3.4 Notes

Id	Ringing tone	Id	Ringing tone
0	ring	5	ramp spmidi
1	baroque	6	mozart imel
2	caribic	7	whenever
3	jamesbond	8	imperialmarch
4	moonstar		

- MIDI Melodies are the same selectable as ringer by **+URNG** command.
- <tone_id> and <nof_repeats> are unused when <audio_resource> is equal to 2 (audio loop).
- The ringer on an incoming call, the alarm tones (**+CALA**) and service tones (e.g.: Call Waiting tone) have the priority on the audio player (+UPAR). If they are not muted and must be played, the audio player (+UPAR) is stopped. Incoming call ringer and service tones can be muted by **+CALM** command (see notes), alarm tones can be muted by <silent> parameter in **+CALA** command.

LISA-U / SARA-U

- <audio_resource>=1 (MIDI player) is not supported.
- The SMS tones have the priority on audio player (+UPAR). If they must be played, the audio player (+UPAR) is stopped. SMS tones can be muted by **+CALM**, **+UMSM** commands.

LEON-G / SARA-G

- The audio player (+UPAR) has the priority on SMS tones. If a player is active, SMS tones are not played.

LISA-U1

- <audio_resource>=2 (audio loop for test purposes) is not supported.

LEON-G

- <audio_resource>=2 (audio loop for test purposes) is not supported



21.4 Stop audio resource (Stop Audio Resource) +USAR

+USAR						
Modules	LEON-G SARA-G340 SARA-G350 LISA-U120 LISA-U130 LISA-U200-01S LISA-U200-02S LISA-U200-52S LISA-U200-62S LISA-U200-82S LISA-U230 LISA-U260 LISA-U270 SARA-U					
Attributes	Syntax	PIN required	Settings saved	Can be aborted	Response time	Error reference
	partial	No	No	No	-	+CME Error

21.4.1 Description

Stops the playback of the selected audio resource.

21.4.2 Syntax

Type	Syntax	Response	Example
Set	AT+USAR=<audio_resource>	OK	AT+USAR=0 OK
Test	AT+USAR=?	+USAR: (list of supported <audio_resource>s) OK	+USAR: (0-2) OK

21.4.3 Defined values

Parameter	Type	Description
<audio_resource>	Number	Specifies the audio resource <ul style="list-style-type: none"> 0: DSP tone generator 1: MIDI player 2: audio loop for test purposes. Use this command to stop an audio loop between uplink and downlink current path (+USPM).
<error>	Number	If an incorrect number of parameters is provided or the parameter values are out of range the error message "+CME ERROR: operation not supported" will be provided if +CMEE is set to 2

21.4.4 Notes

LISA-U1

- <audio_resource>=1 (MIDI player) is not supported.
- <audio_resource>=2 (audio loop for test purposes) is not supported.

LISA-U2 / SARA-U

- <audio_resource>=1 (MIDI player) is not supported.

LEON-G

- <audio_resource>=2 (audio loop for test purposes) is not supported

21.5 Play audio file +UPLAYFILE

+UPLAYFILE						
Modules	LEON-G SARA-G340 SARA-G350 LISA-U120 LISA-U130 LISA-U200-01S LISA-U200-02S LISA-U200-52S LISA-U200-62S LISA-U200-82S LISA-U230 LISA-U260 LISA-U270 SARA-U					
Attributes	Syntax	PIN required	Settings saved	Can be aborted	Response time	Error reference
	partial	No	No	No	-	+CME Error

21.5.1 Description

Play the specified audio file stored into the file system. The audio signal from the player is only routed to the downlink path. For more details about file system description see the [Chapter 20](#).

If the player reaches the end of the file, the player is stopped and a "+UPLAYFILE" URC is issued.



If the player is stopped before reaching the end of the file and a "+UPLAYFILE STOPPED" URC is provided.

The player can be stopped before end of file by AT+USTOPFILE command or automatically in case of these events:

- Call dialup or hangup during file playing
- Call handover with a narrow band/wide band speech change during file playing



When finish playing the file, a status indication is sent to DTE in a form of +UPLAYFILE.



It is not possible to route the audio signal from the player to the uplink path; the signal is only routed to the downlink path.

21.5.2 Syntax

Type	Syntax	Response	Example
Set	AT+UPLAYFILE=<filename>	OK	AT+UPLAYFILE="file1.amr" OK
Read	AT+UPLAYFILE?	+UPLAYFILE: <playstatus> OK	+UPLAYFILE: 0 OK
URC		+UPLAYFILE STOPPED	

21.5.3 Defined values

Parameter	Type	Description
<filename>	String	Specifies the audio resource file name to be played
<playstatus>	Number	Play status <ul style="list-style-type: none"> • 0: no file is playing • 1: the file is playing
<error>	Number	<ul style="list-style-type: none"> • If an incorrect number of parameters is provided or the parameter values are out of range the error message "+CME ERROR: operation not supported" will be provided if +CMEE is set to 2 • If <filename> file is not present in the file system the error message "+CME ERROR: FILE NOT FOUND" will be provided if +CMEE is set to 2

21.5.4 Notes

LISA-U2 / SARA-U

- The +CRSL command does not impact the volume of the audio file player. The player volume is affected by <Mix_afe> parameter and <Scal_Rec> (see the +USGC command).
- Modules support the PCM audio file. The storage format of PCM audio files must be: 8 kHz sample rate, signed 16 bits, little endian, mono.

LISA-U1

- If +CRSL is set to 0, the audio file player is muted, otherwise +CRSL does not change the volume of the audio file player. The player volume is changed by <Mix_afe> parameter, <Scal_Rec> and <Analog_gain> parameters (see the +USGC command).
- Modules support the PCM audio file. The storage format of PCM audio files must be: 8 kHz sample rate, signed 16 bits, little endian, mono.

LEON-G / SARA-G

- The +CRSL command selects the player volume; if +CRSL (Ringer Sound Level) is set to 0 or +CALM (Alert Sound Mode) is set to 1, the +UPLAYFILE command returns an error message (+CME ERROR: operation not supported). The player volume is also changed by <Scal_Rec> and <Analog_gain> parameters (see the +USGC command).
- Modules support the AMR audio file. The storage format of AMR encoded audio content must be compliant to RFC3267 [54].
- The URC (+UPLAYFILE STOPPED) is not supported.

21.6 Stop audio file +USTOPFILE

+USTOPFILE						
Modules	LEON-G SARA-G340 SARA-G350 LISA-U120 LISA-U130 LISA-U200-01S LISA-U200-02S LISA-U200-52S LISA-U200-62S LISA-U200-82S LISA-U230 LISA-U260 LISA-U270 SARA-U					
Attributes	Syntax	PIN required	Settings saved	Can be aborted	Response time	Error reference
	full	No	No	No	-	+CME Error

21.6.1 Description

Stop the audio file reproduction.

A URC is provided after the AT+USTOPFILE command correctly stopped the file.



The player is stopped and a URC (+UPLAYFILE STOPPED) is provided in the following cases:

- Call dialup or hangup during file playing
- Call handover with a narrow band/wide band speech change during file playing

21.6.2 Syntax

Type	Syntax	Response	Example
Action	AT+USTOPFILE	OK	AT+USTOPFILE OK
URC		+UPLAYFILE STOPPED	

21.6.3 Notes

LEON-G1 / SARA-G340 / SARA-G350

- The URC is not available.

21.7 Tone generator (Tone GeNerator) +UTGN

+UTGN						
Modules	LEON-G SARA-G340 SARA-G350 LISA-U120 LISA-U130 LISA-U200-01S LISA-U200-02S LISA-U200-52S LISA-U200-62S LISA-U200-82S LISA-U230 LISA-U260 LISA-U270 SARA-U					
Attributes	Syntax	PIN required	Settings saved	Can be aborted	Response time	Error reference
	full	No	No	No	-	+CME Error

21.7.1 Description

Starts a tone on the module tone generator. The frequency, duration and volume of the tone must be set.

21.7.2 Syntax

Type	Syntax	Response	Example
Set	AT+UTGN=<freq>,<duration>,<volume>[,<UplinkSending>]	OK	AT+UTGN=1000,1000,100,1 OK
Test	AT+UTGN=?	+UTGN: (range of supported <freq> values in Hz),(range of supported <duration>s in msec),(range of supported <volume> values)[,(range of supported <UplinkSending> values)] OK	+UTGN: (300-3400),(50-1360),(1-100),(0-2) OK

21.7.3 Defined values

Parameter	Type	Description
<freq>	Number	Frequency of the sinus waveform in Hz for the tone generator; the range goes from 300 to 3400 Hz



Parameter	Type	Description
<duration>	Number	Duration of the tone in milliseconds; the allowed values are from 50 to 1360
<volume>	Number	Volume for the tone generator. Allowed values are 1-100; volume 1 means muted. Increasing step is 0.25 dB
<UplinkSending>	Number	Enables/disables the connection of the tone generator to uplink and/or downlink path: <ul style="list-style-type: none"> • 0 (default value): the tone is sent only on downlink path • 1: the tone is sent only on uplink path • 2: the tone is sent both on downlink and uplink path
<error>	Number	If an incorrect number of parameters is provided or the parameter values are out of range the error result code (+CME ERROR: operation not supported) will be provided.

21.7.4 Notes

- The tone playing can be stopped by set command: AT+UTGN=0,0,0. If no tone is playing an error result code (+CME ERROR: operation not supported) is returned.
- If the "silent mode" is enabled (+CALM=1) the +UTGN command returns an error result code (+CME ERROR: operation not supported).
- The ringer on an incoming call, the alarm tones (+CALA) and service tones (e.g.: Call Waiting tone) have the priority on the tone generator (+UTGN). If they are not muted and must be played, the tone generator (+UTGN) is stopped. An incoming call ringer and service tones can be muted by +CALM command (see notes), alarm tones can be muted by <silent> parameter in +CALA command.

LISA-U / SARA-U

- The SMS tones have the priority on the tone generator (+UTGN). If they must be played, the tone generator (+UTGN) is stopped. SMS tones can be muted by +CALM, +UMSM commands.

LEON-G / SARA-G

- The tone generator (+UTGN) has the priority on SMS tones. If tone generator is active, SMS tones are not played.
- The range <duration> parameter goes from 10 to 8000.

LISA-U1

- The range <duration> parameter goes from 10 to 1360.

21.8 Ringing tone selection +URNG

+URNG						
Modules	LEON-G SARA-G340 SARA-G350 LISA-U120 LISA-U130 LISA-U200-01S LISA-U200-02S LISA-U200-52S LISA-U200-62S LISA-U200-82S LISA-U230 LISA-U260 LISA-U270 SARA-U					
Attributes	Syntax	PIN required	Settings saved	Can be aborted	Response time	Error reference
	full	No	NVM	No	-	+CME Error

21.8.1 Description

Allows the user to select one out of a set of predefined ringers.

21.8.2 Syntax

Type	Syntax	Response	Example
Set	AT+URNG=<rng_id>	OK	AT+URNG=5 OK
Read	AT+URNG?	+URNG: <rng_id> OK	+URNG: 0 OK
Test	AT+URNG=?	+URNG: (list of supported <rng_id>s) OK	+URNG: (0-18) OK

21.8.3 Defined values

Parameter	Type	Description
<rng_id>	Number	Ringer identifier currently selected; the factory-programmed value is 0
<rng_name_x>	Number	Name of the ringer saved in the module
<error>	Number	If an incorrect number of parameters is provided or the parameter value is out of range the error message "operation not supported" will be provided

21.8.4 Notes

LEON-G / SARA-G340 / SARA-G350

- The test command is:
+URNG:
0 - <rng_name_1>
1 - <rng_name_2>
...
rng_max_num - <rng_name_n>
OK
- If <rng_id> value is not allowed the error message "Wrong ringer identifier" will be provided.

21.9 SMS alert sound mode (Message Sound Muting) +UMSM

+UMSM						
Modules	LEON-G SARA-G340 SARA-G350 LISA-U120 LISA-U130 LISA-U200-01S LISA-U200-02S LISA-U200-52S LISA-U200-62S LISA-U200-82S LISA-U230 LISA-U260 LISA-U270 SARA-U					
Attributes	Syntax	PIN required	Settings saved	Can be aborted	Response time	Error reference
	full	No	No	No	-	+CME Error

21.9.1 Description

Mutes the signalling sound of SMS on the MT.

21.9.2 Syntax

Type	Syntax	Response	Example
Set	AT+UMSM=<mode>	OK	AT+UMSM=0 OK
Read	AT+UMSM?	+UMSM: <mode> OK	+UMSM: 0 OK
Test	AT+UMSM=?	+UMSM: (list of supported <mode>s) OK	+UMSM: (0-1) OK

21.9.3 Defined values

Parameter	Type	Description
<mode>	Number	<ul style="list-style-type: none"> 0 (default value): normal mode (the signalling sound of SMS on the MT is not muted) 1: silent mode (the signalling sound of SMS on the MT is muted)
<error>	Number	If an incorrect number of parameters is provided or the parameter value is out of range the error message "+CME ERROR: operation not supported" will be provided if +CMEE is set to 2

21.10 Master Clock Control +UMCLK

+UMCLK						
Modules	LISA-U2 SARA-U					
Attributes	Syntax	PIN required	Settings saved	Can be aborted	Response time	Error reference
	full	No	<i>NVM</i>	No	-	<i>+CME Error</i>

21.10.1 Description

Enables or disables the clock generation on the CODEC_CLK pin of u-blox cellular modules with digital audio interface. For more details see the corresponding module System Integration Manual [49]. This signal must be connected to the clock input of an external audio codec (see note).

The available output pin configurations are:

- Disabled, set as tristate
- Pin output low
- Generate 13 MHz clock
- Generate 26 MHz clock

Depending on the <enabling_mode> parameter value, the configuration can be applied as soon as the command is invoked, or as soon as there is an audio activity (i.e. a digital audio interface is enabled).

 The CODEC_CLK pin must be connected to the clock input of the external codec.

21.10.2 Syntax

Type	Syntax	Response	Example
Set	AT+UMCLK=[<mclk_mode>[,<enabling_mode>]]	OK	AT+UMCLK=1,1 OK
Read	AT+UMCLK?	+UMCLK: <mclk_mode>,<enabling_mode> OK	+UMCLK: 1,1 OK
Test	AT+UMCLK=?	+UMCLK: (list of supported <mclk_mode>s),(list of supported <enabling_mode>s) OK	+UMCLK: (0-3),(0-1) OK

21.10.3 Defined values

Parameter	Type	Description
<mclk_mode>	Number	CODEC_CLK pin setting <ul style="list-style-type: none"> • 0 (default and factory-programmed value): disabled pin; 3-state with pull down resistor • 1: pin output steady low • 2: codec master clock at 13 MHz • 3: codec master clock at 26 MHz
<enabling_mode>	Number	Specifies when the <mclk_mode> is enabled on CODEC_CLK pin <ul style="list-style-type: none"> • 0 (default and factory-programmed value): "Audio dependent" mode <mclk_mode> is applied to the CODEC_CLK pin only when the audio path is active (audio samples are read on the I2S_RX line and written on the I2S_TX line). When the audio path is disabled (i.e. at call end), then the CODEC_CLK pin is disabled too (3-state with pull-down resistor) • 1: "Continuous" mode <mclk_mode> is applied to the CODEC_CLK pin as soon as the AT command is invoked, even when the module is in idle and the audio path is disabled (no audio data written on I2S_TX line, no audio data read on I2S_RX line) When <mclk_mode> is 0 (pin disabled) and <enabling_mode> is 0 ("Audio dependent" mode), the CODEC_CLK pin is disabled both when audio path is enabled or disabled. In this case "Audio dependent" mode matches with "Continuous" mode (the command AT+UMCLK=0,0 and AT+UMCLK=0,1 are equivalent).

21.10.4 Notes

- If <mcclk_mode>= 1 ("Continuous" mode) the actual clock generation occurs within 10 ms of the command invocation.
- If the +UPSV AT command enables the power saving, the 13 or 26 MHz clock is turned off while the module enters the low power idle-mode, even if <mcclk_mode> is "Continuous" mode. So, for <mcclk_mode> = 2 or 3, the 13 or 26 MHz clock is continuously generated only if power saving is disabled (+UPSV=0 setting).
- Changes are saved in NVM, but they can be recovered by calling AT+UMCLK= (with no parameters).
- Setting of +UMCK can be forced at boot by +UEXTDCONF setting.

21.11 External Device Configuration +UEXTDCONF

+UEXTDCONF						
Modules	LISA-U200-01S LISA-U200-02S LISA-U200-52S LISA-U200-62S LISA-U200-82S LISA-U230 LISA-U260 LISA-U270 SARA-U					
Attributes	Syntax	PIN required	Settings saved	Can be aborted	Response time	Error reference
	full	No	NVM	No	-	+CME Error

21.11.1 Description



LISA-U2x0-x1S / LISA-U2x0-x2S

To be used if and only if the I²C lines are biased high by external pull-ups providing proper circuit connection to an external audio codec.

Configures an external device, e.g. an audio codec, at the boot time.

The setting (on / off) for each supported device is saved in NVM and applied everytime the module is powered on.

The configuration for each supported device is hard-coded in the firmware.

Currently, the only supported external device is the Maxim MAX9860 audio codec. See Maxim datasheet [69].

21.11.2 Syntax

Type	Syntax	Response	Example
Set	AT+UEXTDCONF=<device_id>[,<configuration_enable>]	OK	AT+UEXTDCONF=0,0 OK
Get	AT+UEXTDCONF?	+UEXTDCONF: <device_1>,<configuration_enable1> ... +UEXTDCONF: <device_N>,<configuration_enableN> OK	+UEXTDCONF: 0,0 +UEXTDCONF: 1,0 +UEXTDCONF: 2,1 OK
Test	AT+UEXTDCONF=?	+UEXTDCONF: (list of supported <device_id>s),(list of supported <configuration_enable>s) OK	+UEXTDCONF: (0-2),(0,1) OK

21.11.3 Defined values

Parameter	Type	Description
<device_id>	Number	Device identifier. The allowed values may vary depending on the FW version. Currently the modules support the following value: <ul style="list-style-type: none"> • 0 (factory-programmed value): Maxim MAX9860 audio codec, connected via I²C When enabled, at every startup the module performs the actions corresponding to the following commands:

Parameter	Type	Description	
		Command	Meaning
		AT+UMCLK=2,0	Set the external codec master clock at 13 MHz
		AT+UI2CO=1,0,0,0x10,0	Open the I ² C logical channel (connected to the external codec)
		AT+UI2CW="0000000108F20240000103300250000008A",18	Send, via I ² C, the specified byte sequence (for external codec configuration)
		AT+UI2CW="049E",2	Send, via I ² C, the specified byte sequence (for external codec configuration)
		AT+UI2CC	Close the I ² C logical channel
The above actions can be used for the Maxim MAX9860, which is available on EVK boards.			
<configuration_enable>	Number	Enables/disables the autoconfiguration of the specified external device:	
		<ul style="list-style-type: none"> 0 (default value, factory-programmed value): disabled 1: enabled 	

21.11.4 Notes

- Setting +UEXTDCONF: 0,1 forces at every startup an action corresponding to AT+UMCLK=2,0 (set the external codec master clock at 13 MHz). Thus +UMCLK:2,0 setting is written in NVM. To undo / remove it, the AT+UMCLK=0 command must be explicitly invoked after every startup with +UEXTDCONF: 0,1.

21.12 Speech codec configuration +UDCONF=30

+UDCONF=30						
Modules	LEON-G100-07S LEON-G100-08S SARA-G340 SARA-G350 LISA-U200-01S LISA-U200-02S LISA-U200-52S LISA-U200-62S LISA-U200-82S LISA-U230 LISA-U260 LISA-U270 SARA-U					
Attributes	Syntax	PIN required	Settings saved	Can be aborted	Response time	Error reference
	partial	No	<i>NVM</i>	No	-	<i>+CME Error</i>

21.12.1 Description

Configures the allowed speech codec to be presented to the network during a voice call setup.

 The new setting is saved in NVM and is immediately used.

21.12.2 Syntax

Type	Syntax	Response	Example
Set	AT+UDCONF=30,<codec_bitmap>	OK	AT+UDCONF=30,31 OK
Read	AT+UDCONF=30	+UDCONF: 30,<active_codec_bitmap>,<supported_codec_bitmap> OK	AT+UDCONF=30 +UDCONF: 30,31,255 OK

21.12.3 Defined values

Parameter	Type	Description
<codec_bitmap>	Number	Bitmask representing the list of available speech codecs to be presented to the network during voice call setup. GSM Full Rate must be always presented to the network, thus is always implicitly set. The allowed range is 1-3135 (equivalent to bits 000000000001-110000111111). The factory-programmed value is 3135. Bit 2, GSM Full Rate, is always implicitly set to 1. See Table 28 for the meaning of each bit and codec availability:
<active_codec_bitmap>	Number	The currently active codecs, in the format described for <codec_bitmap>
<supported_codec_bitmap>	Number	The list of currently supported codecs, in the format described for <codec_bitmap>



21.12.4 Notes

Bit	Codec	LISA-U2 / SARA-U2	LEON-G1	SARA-G3
0	Full Rate Adaptive Multi-Rate	•	•	•
1	GSM Enhanced Full Rate (12.2 kb/s)	•	•	•
2	GSM Full Rate (13.0 kb/s)	•	•	•
3	Half Rate Adaptive Multi-Rate	•	•	•
4	GSM Half Rate (5.6 kb/s)	•	•	•
5	Full Rate Adaptive Multi-Rate WideBand	•		
6	8-PSK Half Rate Adaptive Multi-Rate			
7	8-PSK Full Rate Adaptive Multi-Rate WideBand			
8	8-PSK Half Rate Adaptive Multi-Rate WideBand			
9	UMTS Adaptive Multi-Rate			
10	UMTS Adaptive Multi-Rate 2	•		
11	UMTS Adaptive Multi-Rate WideBand	•		

Table 28: Speech codec bit meaning and availability on modules

LISA-U

- The supported codec list may vary for each product. The <supported_codec_bitmap> must be checked before making any change.

LISA-U2x0-01S / LISA-U200-00S

- The bit 2 (GSM Full Rate) in <codec_bitmap> can be set to 0.

SARA-G340 / SARA-G350

- The allowed range of <codec_bitmap> is 1-31 (equivalent to bits 00001-11111). The factory-programmed value is 31.

LEON-G

- The allowed range of <codec_bitmap> is 0-31 (equivalent to bits 00000-11111). The factory-programmed value is 31.

22. Audio parameters tuning

22.1 Introduction

The audio driver switches the uplink and downlink audio paths. For example the uplink path can be switched from the handset microphone to the headset microphone and the downlink path can be switched from the handset earpiece to the loudspeaker (see [+USPM](#) for more details). Each path includes a set of parameters that are loaded by the audio driver in the voiceband processing system; for example the uplink path can include the gain of the microphone that can be different for handset or headset microphone path.

For each audio path, these AT commands allows the configuration of the uplink and downlink audio paths parameters:

- [AT+UMGC](#): Microphone Gain Control
- [AT+USGC](#): Speaker Gain Control
- [AT+USTN](#): Sidetone
- [AT+UUBF](#): Uplink Biquad Filters
- [AT+UDBF](#): Downlink Biquad Filters
- [AT+UHFP](#): Hands-Free Parameters

The audio parameters configuration for all the audio paths can be stored in one of the two available user profiles in NVM (see the [AT&W](#) command description).

The audio parameters in the user profiles in NVM are managed by commands [AT&W](#) (it saves in profile 0 or profile 1), [AT&F](#) (it resets to the factory profile), [AT&Y](#) (it selects user profile to be used after hardware reset) and [ATZ](#) (it reloads the user profile).

[AT&V](#) command does not display audio parameters. The audio parameters can be displayed by the corresponding read command, for example [AT+UMGC?](#).

The paragraphs starting from [+UMGC](#) explain each audio parameters tuning command in detail.

See the next subsections for an explanation of the audio path relations and position in the audio paths of parts affected by audio parameters.

22.1.1 LEON-G

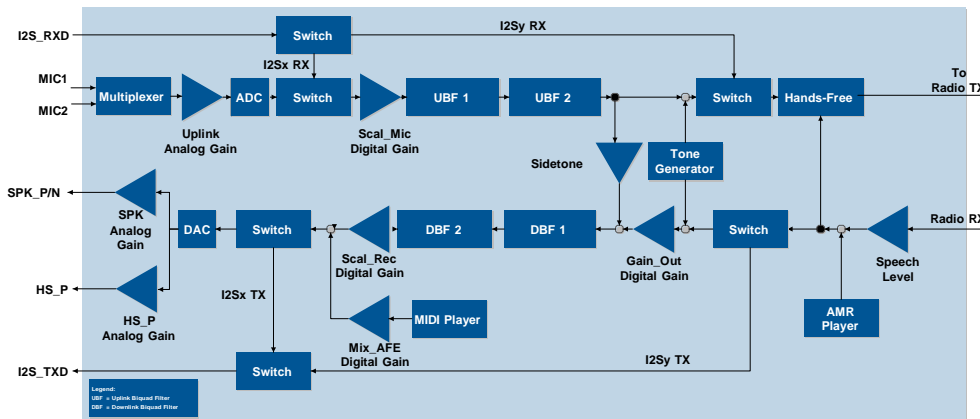

Figure 1: LEON-G series audio paths

- Allowed values for audio path tuning:
 - o `<uplink_path_num>`
 - 0: handset microphone (pins: MIC_BIAS1, MIC_GND1)

- 1: headset microphone (pins: MIC_BIAS2, MIC_GND2)
- 2: I²S input line (pin I2S_RXD)
- o **<downlink_path_num>**
 - 0: normal earpiece (pins: HS_P, GND)
 - 1: mono headset (pins: HS_P, GND)
 - 3: loudspeaker (pins: SPK_P, SPK_N)
 - 4: I²S output line (pin I2S_TXD)
- The module supports the following speech codecs for GSM:
 - o Fullrate Speech Codec (8 kHz sampling rate)
 - o Enhanced Fullrate Speech Codec (8 kHz sampling rate)
 - o Halfrate Speech Codec (8 kHz sampling rate)
 - o NB-AMR Speech Codec (8 kHz sampling rate)
 - o All these codecs are based on a 8 kHz sampling rate, thus all the biquad filters work at 8 kHz sampling rate.
- The tone generator generate the tones (see the **+UTGN** command), the pre-defined tones (see the **+UPAR** command), the alarm tone (see the **+CALA** command), the SMS reception tone and service tones (e.g.: Call Waiting tone). They are affected by <Gain_out>, <Scal_Rec> and <Analog_gain> parameters (see the **+USGC** command). The MIDI melodies (see the **+UPAR** command) and ringer tones on an incoming call are generated by the MIDI player and their volume is affected by <Mix_afe> parameter (see the **+USGC** command). The AMR player (see the **+UPLAYFILE** command) is affected by <Gain_out>, <Scal_Rec> and <Analog_gain> parameters (see the **+USGC** command). See also **+CRSL** command and **+CALM** command.

22.1.2 SARA-G340 / SARA-G350

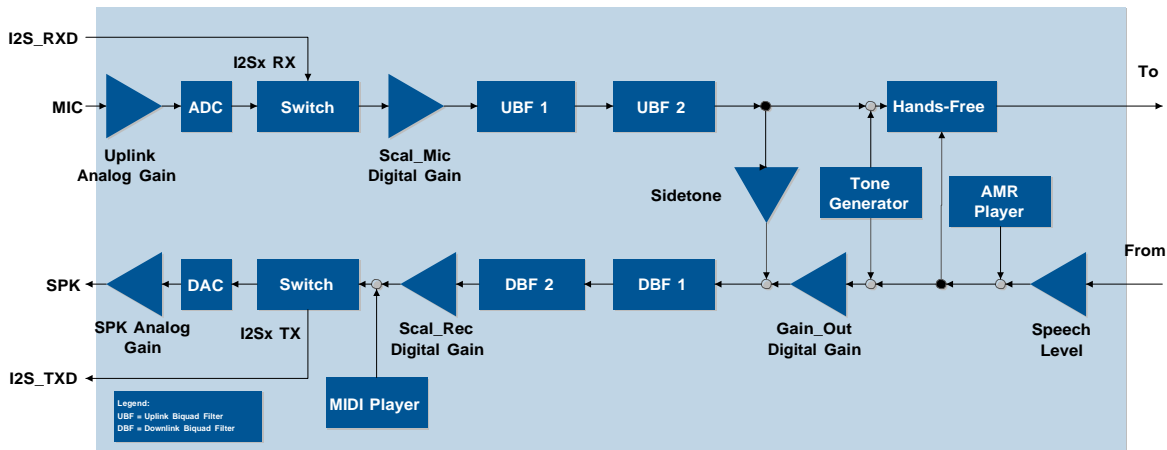

Figure 2: SARA-G350 / SARA-G340 audio paths

- Allowed values for audio path tuning:
 - o **<uplink_path_num>**
 - 0: handset microphone (pins: MIC_P, MIC_N, MIC_BIAS, MIC_GND)
 - 1: headset microphone (pins: MIC_P, MIC_N, MIC_BIAS, MIC_GND)
 - 2: I²S input line (pin I2S_RXD)
 - 4: hands-free microphone (pins: MIC_P, MIC_N, MIC_BIAS, MIC_GND)
 - o **<downlink_path_num>**
 - 0: normal earpiece (pins: SPK_N, SPK_P)
 - 1: mono headset (pins: SPK_N, SPK_P)
 - 3: loudspeaker (pins: SPK_N, SPK_P)

- 4: I²S output line (pin I2S_TXD)
- The module supports the following speech codecs for GSM:
 - o Fullrate Speech Codec (8 kHz sampling rate)
 - o Enhanced Fullrate Speech Codec (8 kHz sampling rate)
 - o Halfrate Speech Codec (8 kHz sampling rate)
 - o NB-AMR Speech Codec (8 kHz sampling rate)
 - o All these codecs are based on a 8 kHz sampling rate, thus all the biquad filters work at 8 kHz sampling rate.
- The tone generator generate the tones (see the **+UTGN** command), the pre-defined tones (see the **+UPAR** command), the alarm tone (see the **+CALA** command), the SMSreception tone and service tones (e.g.: Call Waiting tone). They are affected by <Gain_out>, <Scal_Rec> and <Analog_gain> parameters (see the **+USGC** command). The MIDI melodies (see the **+UPAR** command) and ringer tones on an incoming call are generated by the MIDI player and their volume is affected by <Mix_afe> parameter (see the **+USGC** command). The AMR player (see the **+UPLAYFILE** command) is affected by <Gain_out>, <Scal_Rec> and <Analog_gain> parameters (see the **+USGC** command). See also **+CRSL** command and **+CALM** command.

22.1.3 LISA-U120 / LISA-U130

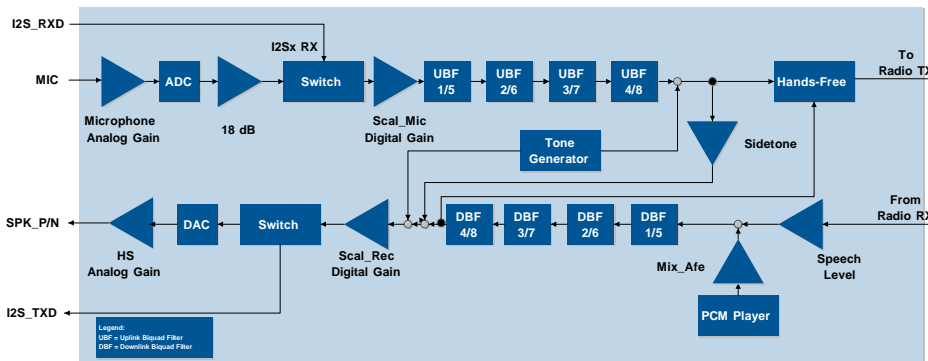

Figure 3: LISA-U120 / LISA-U130 audio paths

- Allowed values for audio path tuning:
 - o <uplink_path_num>
 - 0: handset microphonepins (pins: MIC_P, MIC_N)
 - 1: headset microphone (pins: MIC_P, MIC_N)
 - 2: I²S input line (pin I2S_RXD)
 - 4: hands-free microphone (pins: MIC_P, MIC_N)
 - o <downlink_path_num>
 - 0: normal earpiece (pins: SPK_N, SPK_P)
 - 1: mono headset (pins: SPK_N, SPK_P)
 - 3: loudspeaker (pins: SPK_N, SPK_P)
 - 4: I²S output line (pin I2S_TXD)
- For both uplink and downlink paths, biquad filters 1-4 are used with speech codec at 8 kHz sampling rate, filters 1-5 are used with speech codec at 16 kHz sampling rate.
- The module supports the following speech codecs for GSM:
 - o Fullrate Speech Codec (8 kHz sampling rate)
 - o Enhanced Fullrate Speech Codec (8 kHz sampling rate)
 - o Halfrate Speech Codec (8 kHz sampling rate)
 - o NB-AMR Speech Codec (8 kHz sampling rate)
 - o WB-AMR Speech Codec (16 kHz sampling rate)

- The module supports the following speech codecs for UMTS:
 - o NB-AMR Speech Codec (8 kHz sampling rate)
 - o WB-AMR Speech Codec (16 kHz sampling rate)

22.1.4 LISA-U2

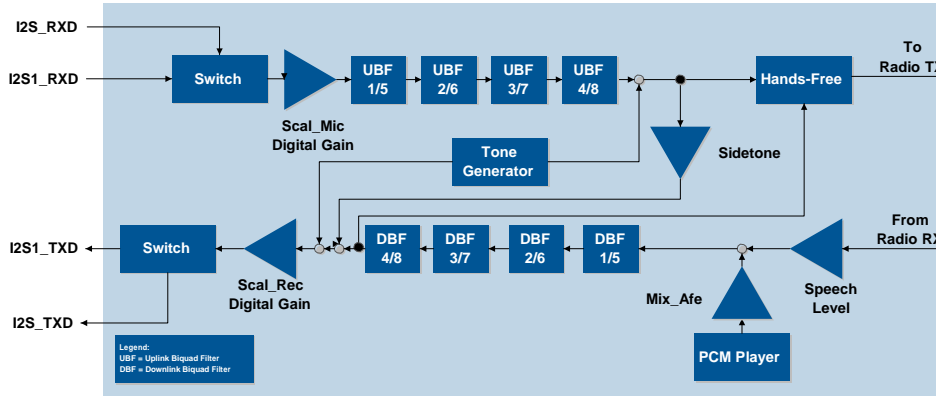

Figure 4: LISA-U2 series audio paths

- Allowed values for audio path tuning:
 - o **<uplink_path_num>**
 - 0: uplink path 0 via I2S
 - 1: uplink path 1 via I2S
 - 2: uplink path 2 via I2S
 - 3: uplink path 3 via I2S
 - 4: uplink path 4 via I2S
 - 5: uplink path 5 via I2S1
 - 6: uplink path 6 via I2S1
 - 7: uplink path 7 via I2S1
 - 8: uplink path 8 via I2S1
 - 9: uplink path 9 via I2S1
 - o **<downlink_path_num>**
 - 0: downlink path 0 via I2S
 - 1: downlink path 1 via I2S
 - 2: downlink path 2 via I2S
 - 3: downlink path 3 via I2S
 - 4: downlink path 4 via I2S
 - 5: downlink path 5 via I2S1
 - 6: downlink path 6 via I2S1
 - 7: downlink path 7 via I2S1
 - 8: downlink path 8 via I2S1
 - 9: downlink path 9 via I2S1
- For downlink path, biquad filters 1-4 are used with speech codec at 8 kHz sampling rate, filters 1-5 are used with speech codec at 16 kHz sampling rate.
- For uplink path, uplink biquad filters 5-8 are used if the I²S sampling rate is 16 kHz, uplink biquad filters 1-4 for all the others I²S sampling rates.
- The module supports the following speech codecs for GSM:
 - o Fullrate Speech Codec (8 kHz sampling rate)

- o Enhanced Fullrate Speech Codec (8 kHz sampling rate)
- o Halfrate Speech Codec (8 kHz sampling rate)
- o NB-AMR Speech Codec (8 kHz sampling rate)
- o WB-AMR Speech Codec (16 kHz sampling rate)
- The module supports the following speech codecs for UMTS:
 - o NB-AMR Speech Codec (8 kHz sampling rate)
 - o WB-AMR Speech Codec (16 kHz sampling rate)
- The tone generator generates the tones (see [+UTGN](#) command), the pre-defined tones and MIDI melodies (see [+UPAR](#) command), the alarm tone (see [+CALA](#) command), the ringer tones on an incoming call, SMS reception tone and the service tones (e.g.: Call Waiting tone). They are affected by the `<Scal_Rec>` digital gain and `<HS_Analog>` gain (see [+USGC](#) command). The PCM player (see [+UPLAYFILE](#) command) is affected by `<Mix_afe>` parameter (see [+USGC](#) command). See also [+CRSL](#) command and [+CALM](#) command.

22.1.5 SARA-U

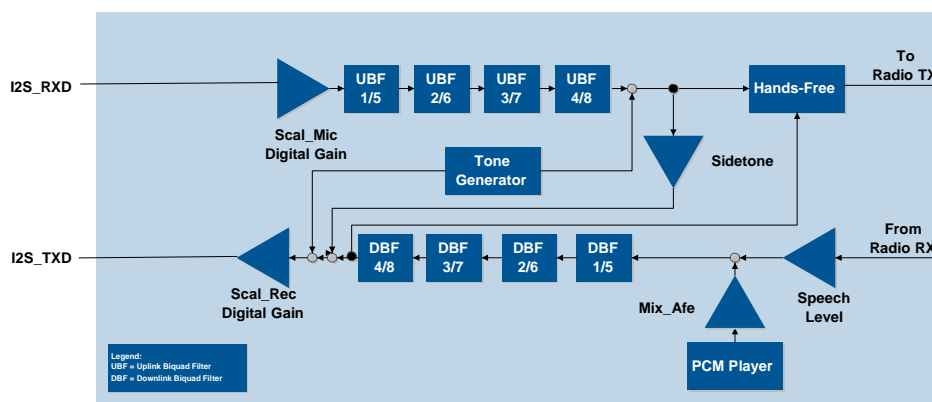



Figure 5: SARA-U series audio paths

- Allowed values for audio path tuning:
 - o `<uplink_path_num>`
 - 0: uplink path 0 via I2S
 - 1: uplink path 1 via I2S
 - 2: uplink path 2 via I2S
 - 3: uplink path 3 via I2S
 - 4: uplink path 4 via I2S
 - o `<downlink_path_num>`
 - 0: downlink path 0 via I2S
 - 1: downlink path 1 via I2S
 - 2: downlink path 2 via I2S
 - 3: downlink path 3 via I2S
 - 4: downlink path 4 via I2S
- For downlink path, biquad filters 1-4 are used with speech codec at 8 kHz sampling rate, filters 1-5 are used with speech codec at 16 kHz sampling rate.
- For uplink path, uplink biquad filters 5-8 are used if the I²S sampling rate is 16 kHz, uplink biquad filters 1-4 for all the others I²S sampling rates.
- The module supports the following speech codecs for GSM:
 - o Fullrate Speech Codec (8 kHz sampling rate)

- o Enhanced Fullrate Speech Codec (8 kHz sampling rate)
- o Halfrate Speech Codec (8 kHz sampling rate)
- o NB-AMR Speech Codec (8 kHz sampling rate)
- o WB-AMR Speech Codec (16 kHz sampling rate)
- The module supports the following speech codecs for UMTS:
 - o NB-AMR Speech Codec (8 kHz sampling rate)
 - o WB-AMR Speech Codec (16 kHz sampling rate)
- The tone generator generates the tones (see [+UTGN](#) command), the pre-defined tones and MIDI melodies (see [+UPAR](#) command), the alarm tone (see [+CALA](#) command), the ringer tones on an incoming call, SMS reception tone and the service tones (e.g.: Call Waiting tone). They are affected by the <Scal_Rec> digital gain and <HS_Analog> gain (see [+USGC](#) command). The PCM player (see [+UPLAYFILE](#) command) is affected by <Mix_afe> parameter (see [+USGC](#) command). See also [+CRSL](#) command and [+CALM](#) command.

22.1.6 Notes

 The tone generator can be routed toward downlink and/or uplink path by <UplinkSending> parameter of [+UTGN](#) command.

The audio parameters in the factory profile are stored in static NVM and the user cannot changed them.

 SARA-G350 / SARA-G340 / LISA-U / SARA-U

- Some parameters present on LEON-G series are not available but they are still maintained in the command for backward compatibility. In this case the 'NA' string appears in the test command; the NA parameter is not stored in the NVM.
E.g.:
AT+USGC?
+USGC: Path 0:
NA,0,8192,16384,NA
- The range of some parameters is extended respect to LEON-G series:
E.g: <filter_number> in +UUBF, +UDBF commands.
- Some commands support new parameters. In this case these parameters are optional, for back compatibility.
E.g.:
<ec_nr_coeff_real> in +UHFP command.

 The speech level is active on call only (no effect on PCM player if not in call).

22.2 Microphone gain (Microphone Gain Control) +UMGC

+UMGC						
Modules	LEON-G SARA-G340 SARA-G350 LISA-U120 LISA-U130 LISA-U200-01S LISA-U200-02S LISA-U200-52S LISA-U200-62S LISA-U200-82S LISA-U230 LISA-U260 LISA-U270 SARA-U					
Attributes	Syntax	PIN required	Settings saved	Can be aborted	Response time	Error reference
	partial	No	<i>Profile</i>	No	-	<i>+CME Error</i>

22.2.1 Description

Configures the uplink path gain.

 See [Chapter 22.1](#) for the position of amplifiers in the audio path.

 Not all the paths are supported. Check the allowed <uplink_path_num> values in the test command response.



Any change in the gain on uplink or downlink path impacts on the amount of echo fed back from the speaker to the microphone. This means that performance of EC algorithm could change and parameters could need to be changed to better fit new gain on uplink or downlink path. See the [+UHFP](#) command description.

22.2.2 Syntax

Type	Syntax	Response	Example
Set	AT+UMGC=<uplink_path_num>,<analog_gain>,<digital_gain>	OK	AT+UMGC=1,12,16000 OK
Read	AT+UMGC?	+UMGC: Path <uplink_path_num>: <analog_gain>,<digital_gain> [...] (for all the supported paths) OK	+UMGC: Path 0: 10,9384 Path 1: 12,8192 Path 2: 6,8192 OK
Test	AT+UMGC=?	+UMGC: (list of supported <uplink_path_num>s),(list of supported <analog_gain>s),(list of supported <digital_gain>s) OK OK	+UMGC: (0-9),(0-14),(0-32767) OK

22.2.3 Defined values

Parameter	Type	Description
<uplink_path_num>	Number	Specifies the uplink path where the gains must be configured. For uplink paths range and physical meaning, see the product specific section in the Chapter 22.1 : <ul style="list-style-type: none"> LEON-G series: Chapter 22.1.1. SARA-G340 / SARA-G350: Chapter 22.1.2 LISA-U120 / LISA-U130: Chapter 22.1.3 LISA-U2 series: Chapter 22.1.4 SARA-U series: Chapter 22.1.5
<analog_gain>	Number	Gain for analog audio front end amplifier <ul style="list-style-type: none"> Range: 0 - 14 (0=0 dB; 14=42 dB; 3 dB/step) For LISA-U2 / SARA-U series the parameter is not available: 'NA' is provided in the test command
<digital_gain>	Number	Gain for Scal_mic digital amplifier <ul style="list-style-type: none"> Range: 0 - 32767 (8192=0 dB; 32767=12 dB; linear)

22.2.4 Notes

LISA-U2 / SARA-U

- <analog_gain> is unused and not mandatory.
- The factory-programmed values for all the paths are set to NA (<analog_gain> parameter) and 8192 (<digital_gain>).

LISA-U120 / LISA-U130

- The factory-programmed values are set as follows:
 - Path 0: <analog_gain>=12 and <digital_gain>=8192.
 - Path 1: <analog_gain>=12 and <digital_gain>=8192.
 - Path 2: <analog_gain>=6 and <digital_gain>=8192.
 - Path 4: <analog_gain>=13 and <digital_gain>=8192.

SARA-G340 / SARA-G350

- The factory-programmed values are set as follows:
 - o Path 0: <analog_gain>=10 and <digital_gain>=8192.
 - o Path 1: <analog_gain>=10 and <digital_gain>=8192.
 - o Path 2: <analog_gain>=6 and <digital_gain>=8192.
 - o Path 4: <analog_gain>=10 and <digital_gain>=8192.

LEON-G

- <uplink_path_num>=4 is not supported.
- The factory-programmed values are set as follows:
 - o Path 0: <analog_gain>=10 and <digital_gain>=9384.
 - o Path 1: <analog_gain>=12 and <digital_gain>=8192.
 - o Path 2: <analog_gain>=6 and <digital_gain>=8192.

22.3 Speaker Gain (Speaker Gain Control) +USGC

+USGC						
Modules	LEON-G SARA-G340 SARA-G350					
	LISA-U120 LISA-U130 LISA-U200-01S LISA-U200-02S LISA-U200-52S LISA-U200-62S LISA-U200-82S LISA-U230 LISA-U260 LISA-U270 SARA-U					
Attributes	Syntax	PIN required	Settings saved	Can be aborted	Response time	Error reference
	partial	No	<i>Profile</i>	No	-	<i>+CME Error</i>

22.3.1 Description

Configures the audio downlink path gain.



See [Chapter 22.1](#) for the position of amplifiers in the audio path.



Not all the paths are supported, see [+USPM](#) command description for the supported paths.



Any change in the gain on uplink or downlink path impacts on the amount of echo fed back from the speaker to the microphone. This means that performance of EC algorithm could change and parameters could need to be changed to better fit new gain on uplink or downlink path. See the [+UHFP](#) command description).

22.3.2 Syntax

Type	Syntax	Response	Example
Set	AT+USGC=<downlink_path_num>[,<SPK_analog_gain>],<HS_analog_gain>,<scal_rec>,<Mix_afe>[,<Gain_out>]	OK	AT+USGC=0,6,6,16000,16000,22000 OK
Read	AT+USGC?	+USGC: Path<downlink_path_num>: <SPK_analog_gain>,<HS_analog_gain>,<scal_rec>,<Mix_afe>,<Gain_Out> [...] (for all the supported path) OK	+USGC: Path 0: 6,6,16000,16000,22000 Path 1: 6,0,8192,16384,10240 Path 3: 0,6,8192,16384,8191 Path 4: 6,6,8192,16384,8191 OK
Test	AT+USGC=?	+USGC: (list of supported <downlink_path_num>s),(list of supported <SPK_analog_gain>s),(list of supported <HS_analog_gain>s),(list of supported <scal_	+USGC: (0-9),(0-6),(0-6),(0-32767),(0-32767),(0-32767) OK



Type	Syntax	Response	Example
		rec>s),(list of supported <Mix_afe>s),(list of supported <Gain_out>s) OK	

22.3.3 Defined values

Parameter	Type	Description
<downlinkpath_num>	Number	Specifies the downlink path where the gains must be configured. For downlink paths range and physical meaning, see the product specific section in the Chapter 22.1 : <ul style="list-style-type: none"> LEON-G series: Chapter 22.1.1 SARA-G340 / SARA-G350: Chapter 22.1.2 LISA-U120 / LISA-U130: Chapter 22.1.3 LISA-U2 series: Chapter 22.1.4 SARA-U series: Chapter 22.1.5
<SPK_analog_gain>	Number	Gain of analog audio amplifier for SPK_P/SPK_N outputs <ul style="list-style-type: none"> On LEON-G modules the range goes from 0 to 6 (-3 dB/step; 0=+9 dB to 6=-9 dB) On SARA-G340 / SARA-G350 modules the range goes from 0 to 5 (-3 dB/step; 0=+9 dB to 5=-6 dB)
<HS_analog_gain>	Number	Gain of analog audio amplifier for SPK_P/SPK_N outputs <ul style="list-style-type: none"> On LEON-G / LISA-U120 / LISA-U130 modules the range goes from 0 to 6 (-3 dB/step; 0=0 dB to 6= -18 dB)
<scal_rec>	Number	Gain of the Scal_rec digital amplifier (speech and tone generator) <ul style="list-style-type: none"> Range: 0 - 32767 (8192=0 dB; 32767=12 dB; linear)
<Mix_afe>	Number	Gains of the Mix_afe digital amplifier (synthesizers) <ul style="list-style-type: none"> Range: 0 - 32767 (16384=0 dB; 32767=6 dB; linear)
<Gain_out>	Number	Gain of the Gain_Out digital amplifier (speech) <ul style="list-style-type: none"> Range: 0 - 32767 (8192=0 dB; 32767=12 dB; linear)

22.3.4 Notes

LISA-U1

- <SPK_analog_gain> and <Gain_out> are unused and not mandatory. 'NA' is provided in the test command.
- The factory-programmed values are set as follows:
 - <SPK_analog_gain> not available for all the paths.
 - <HS_analog_gain>= 0 for the path 0, <HS_analog_gain>= 1 for the path 1, <HS_analog_gain>= 0 for the path 3, <HS_analog_gain>= 3 for the path 4.
 - <scal_rec>= 8192 for all the paths.
 - <Mix_afe>= 16384 for all the paths.
 - <Gain_out> not available for all the paths.

LISA-U2 / SARA-U

- <SPK_analog_gain>, <HS_analog_gain> and <Gain_out> are unused and not mandatory. 'NA' is provided in the test command.
- The factory-programmed values are set as follows:
 - <SPK_analog_gain> not available for all the paths.
 - <HS_analog_gain> not available for all the paths.
 - <scal_rec>= 8192 for all the paths.
 - <Mix_afe>= 16384 for all the paths.
 - <Gain_out> not available for all the paths.

SARA-G350 / SARA-G340

- <HS_analog_gain> and <Mix_afe> are unused and not mandatory. 'NA' is provided in the test command.

- The factory-programmed values are set as follows:
 - o <SPK_analog_gain>=3 for path 0, 1, 3 and <SPK_analog_gain>=5 for path 4.
 - o <HS_analog_gain>=3 for path 0, 1, 3 and <SPK_analog_gain>=0 for path 4.
 - o <scal_rec>= 8192 for all the paths.
 - o <Mix_afe>= 16384 for all the paths.
 - o <Gain_out>= 8192 for all the paths.

LEON-G

- The factory-programmed values are set as follows:
 - o <SPK_analog_gain>=6 for path 0, 1, 4 and <SPK_analog_gain>=0 for path 3.
 - o <HS_analog_gain>=1 for path 0, <HS_analog_gain>=0 for path 1, <HS_analog_gain>=6 for path 3 and 4.
 - o <scal_rec>= 8192 for all the paths.
 - o <Mix_afe>= 16384 for all the paths.
 - o <Gain_out>= 8192 for path 0, <Gain_out>= 10240 for path 1, <Gain_out>= 8191 for path 3 and 4.

22.4 Sidetone (SideToNe) +USTN

+USTN						
Modules	LEON-G SARA-G340 SARA-G350					
	LISA-U120 LISA-U130 LISA-U200-01S LISA-U200-02S LISA-U200-52S LISA-U200-62S LISA-U200-82S LISA-U230 LISA-U260 LISA-U270 SARA-U					
Attributes	Syntax	PIN required	Settings saved	Can be aborted	Response time	Error reference
	full	No	<i>Profile</i>	No	-	<i>+CME Error</i>

22.4.1 Description

Changes the sidetone gain for a specific downlink path. Sidetone is a part of the user's speech on uplink path that should be listened on downlink path by the user himself to have perception the call is on.



Not all the paths are supported, see [Chapter 21.1](#) for the supported paths.



See [Chapter 22.1](#) for the position of sidetone gain in the audio path.

22.4.2 Syntax

Type	Syntax	Response	Example
Set	AT+USTN=<downlink_path_num>,<sidetone_gain>	OK	AT+USTN=1,1000 OK
Read	AT+USTN?	+USTN: Path<downlink_path_num>: <sidetone_gain> [...] (all the supported path) OK	+USTN: Path 0: 2249 Path 1: 2249 OK
Test	AT+USTN=?	+USTN: (list of supported <downlink_path_num>s),(list of supported <sidetone_gain>s) OK	+USTN: (0-9),(0-32767) OK

22.4.3 Defined values

Parameter	Type	Description
<downlink_path_num>	Number	Specifies the downlink path where the sidetone must be configured. For downlink paths range and physical meaning, see the product specific section in the Chapter 22.1 : <ul style="list-style-type: none"> • LEON-G series: Chapter 22.1.1. • SARA-G340 / SARA-G350: Chapter 22.1.2 • LISA-U120 / LISA-U130: Chapter 22.1.3 • LISA-U2 series: Chapter 22.1.4 • SARA-U series: Chapter 22.1.5
<sidetone_gain>	Number	Gain for Sidetone digital amplifier <ul style="list-style-type: none"> • Range: 0 - 32767: (16384=0 dB; 32767=6 dB; linear)

22.5 Uplink Digital Filters (Uplink Biquad Filters) +UUBF

+UUBF						
Modules	LEON-G SARA-G340 SARA-G350 LISA-U120 LISA-U130 LISA-U200-01S LISA-U200-02S LISA-U200-52S LISA-U200-62S LISA-U200-82S LISA-U230 LISA-U260 LISA-U270 SARA-U					
Attributes	Syntax	PIN required	Settings saved	Can be aborted	Response time	Error reference
	partial	No	<i>Profile</i>	No	-	<i>+CME Error</i>

22.5.1 Description

Sets the digital audio filters parameters for a specific uplink path.



See [Chapter 22.1](#) for the position of the filters in the audio path.



Not all the paths are supported, see [+USPM](#) command description for the supported paths.

22.5.2 Syntax

Type	Syntax	Response	Example
Set	AT+UUBF=<uplinkpath_num>,<filter_number>,<a1>,<b1>,<a2>,<b2>,<a0>	OK	AT+UUBF=0,1,-13915,2249,4377,-325,23450 OK
Read	AT+UUBF?	+UUBF: Path =<uplinkpath_num>: Filter1: a1:<a1>, b1:<b1>, a2:<a2>, b2:<b2>, a0:<a0> Filter2: a1:<a1>, b1:<b1>, a2:<a2>, b2:<b2>, a0:<a0> Filter3: a1:<a1>, b1:<b1>, a2:<a2>, b2:<b2>, a0:<a0> Filter4: a1:<a1>, b1:<b1>, a2:<a2>, b2:<b2>, a0:<a0> Filter5: a1:<a1>, b1:<b1>, a2:<a2>, b2:<b2>, a0:<a0> Filter6: a1:<a1>, b1:<b1>, a2:<a2>, b2:<b2>, a0:<a0> [...] (for all the supported paths) OK	+UUBF: Path 0: Filter1: a1:0, b1:0, a2:0, b2:0, a0:32767 Filter2: a1:0, b1:0, a2:0, b2:0, a0:32767 Filter3: a1:0, b1:0, a2:0, b2:0, a0:32767 Filter4: a1:0, b1:0, a2:0, b2:0, a0:32767 Filter5: a1:0, b1:0, a2:0, b2:0, a0:32767 Filter6: a1:0, b1:0, a2:0, b2:0, a0:32767 Filter7: a1:0, b1:0, a2:0, b2:0, a0:32767 Filter8: a1:0, b1:0, a2:0, b2:0, a0:32767 [repeated for each path] OK
Test	AT+UUBF=?	+UUBF: (list of supported <uplinkpath_num>s),(list of supported <filter_number>s),(list of supported <a1>s),(list of supported <b1>s),(list of supported <a2>s),(list of supported <b2>s),(list of supported <a0>s) OK	+UUBF: (0-9),(1-8),(-32768:32767),(-32768:32767),(-32768:32767),(-32768:32767),(-32768:32767) OK

22.5.3 Defined values

Parameter	Type	Description
<uplink_path_num>	Number	<p>Specifies the uplink path where the digital filters must be configured.</p> <p>For uplink paths range and physical meaning, see the product specific section in the Chapter 22.1:</p> <ul style="list-style-type: none"> • LEON-G series: Chapter 22.1.1 • SARA-G340 / SARA-G350: Chapter 22.1.2 • LISA-U120 / LISA-U130: Chapter 22.1.3 • LISA-U2 series: Chapter 22.1.4 • SARA-U series: Chapter 22.1.5
<filter_number>	Number	<p>On LEON-G1 series: two digital biquad filters in cascade are available for each uplink path (Filter1, Filter2). See Chapter 22.1.1 for the filter position. The range goes from 1 to 2.</p> <p>On SARA-G350 / SARA-G340 series: two digital biquad filters in cascade are available for each uplink path (Filter1, Filter2). See Chapter 22.1.2 for the filter position. The range goes from 1 to 2.</p> <p>On LISA-U1 series: four digital biquad filters in cascade are available for each uplink path. See Chapter 22.1.3 for the filter position. Filters 1-4 are used for Narrow Band speech (8 kHz sampling rate i.e. with HR, FR, EFR, NB-AMR codec). Filters 1-5 are used for Wide Band speech (16 kHz sampling rate i.e. with WB-AMR). The range goes from 1 to 8.</p> <p>On LISA-U2 / SARA-U series: four digital biquad filters in cascade are available for each uplink path. See Chapter 22.1.4 for the filter position on LISA-U2 and to Chapter 22.1.5 for the filter position on SARA-U. Filters 5-8 are used if the I²S sampling rate is 16 kHz. Filters 1-4 are used if the I²S sampling rate is other than 16 kHz.</p>
<a1>,<b1>,<a2>,<b2>,<a0>	Number	<p>Biquad filter coefficients. The range goes from -32768 to 32767.</p> <p>The factory-programmed value for a1, b1, a2 and b2 is 0 and for a0 is 32767.</p>

22.5.4 Notes

The biquad filter transfer function is

$$H(z) = \frac{A_0 + 2A_1 z^{-1} + A_2 z^{-2}}{1 + 2B_1 z^{-1} + B_2 z^{-2}}$$

with coefficients A_0, A_1, A_2, B_1, B_2 in the range -1:1

The command parameters are filter coefficients scaled in the range that goes from -32768 to 32767

- <a1>=32767 * A_1
- <b1>=32767 * B_1
- <a2>=32767 * A_2
- <b2>=32767 * B_2
- <a0>=32767 * A_0

For the computation of the coefficients, consider the corresponding sampling rate for each product (according to speech codec in use, as explained in [Chapter 22.1](#)).

LEON-G / SARA-G350 / SARA-G340

- 8 kHz sampling rate. Filters are 'Narrow Band' (0 - 4 kHz)

LISA-U120 / LISA-U130

- 8 kHz sampling rate for <filter_number>= (1-4). These filters are used when speech codec is HR, FR, EFR or NB-AMR (speech sampling rate is 8 kHz), thus filters are 'Narrow Band' (0 - 4 kHz).
- 16 kHz sampling rate for <filter_number>= (5-8). These filters are used when speech codec is WB-AMR (speech sampling rate is 16 kHz), thus filters are 'Wide Band' (0 - 8 kHz).

**LISA-U2 / SARA-U**

- 16 kHz sampling rate for <filter_number>= (5-8). These filters are used if the I²S sampling rate is 16 kHz.
- Same sampling rate of I²S in use, for <filter_number>= (1-4). These filters are used if the I²S sampling rate is other than 16 kHz.

Example:

Set both headset microphone filters to all pass:

In this case the biquad filter transfer function is

$$H(z)=1$$

Then the coefficients are

$$A0=1$$

$$A1=A2=B1=B2=0$$

Thus parameters are: <a1>=0 ,<b1> =0 ,<a2>=0 ,<b2>= 0 ,<a0>=32767

Commands are:

AT+UUBF=1,1, 0,0,0,0, 32767

AT+UUBF=1,2, 0,0,0,0, 32767

LEON-G

- <uplink_path_num>=4 is not supported.
- The factory-programmed values are as follows:
 - o Path 0:
 - Filter1: a1=-13915, b1=2249, a2=4377, b2=-325, a0=23450
 - Filter2: a1=21682, b1=-2312, a2=17984, b2=-15517, a0=32767
 - o Path 1:
 - Filter1: a1=-29322, b1=-29141, a2=29322, b2=26240, a0=29322
 - Filter2: a1=29322, b1=29141, a2=29322, b2=26240, a0=29322
 - o Path 2:
 - Filter1: a1=0, b1=0, a2=0, b2=0, a0=32767
 - Filter2: a1=0, b1=0, a2=0, b2=0, a0=32767

22.6 Downlink Digital Filters (Downlink Biquad Filters) +UDBF

+UDBF						
Modules	LEON-G SARA-G340 SARA-G350 LISA-U120 LISA-U130 LISA-U200-01S LISA-U200-02S LISA-U200-52S LISA-U200-62S LISA-U200-82S LISA-U230 LISA-U260 LISA-U270 SARA-U					
Attributes	Syntax	PIN required	Settings saved	Can be aborted	Response time	Error reference
	full	No	Profile	No	-	+CME Error

22.6.1 Description

Configures the digital audio filters parameters for a specific downlink path.



See [Chapter 22.1](#) for the position of the filters in the audio path.



Not all paths are supported, see [+USPM](#) command description for the supported paths.



22.6.2 Syntax

Type	Syntax	Response	Example
Set	AT+UDBF=<downlinkpath_num>,<filter_number>,<a1>,<b1>,<a2>,<b2>,<a0>	OK	AT+UDBF=0,1, -13915,2249,4377,-325,23450 OK
Read	AT+UDBF?	+UDBF: Path =<downlinkpath_num>: Filter1: a1:<a1>, b1:<b1>, a2:<a2>, b2:<b2>, a0:<a0> Filter2: a1:<a1>, b1:<b1>, a2:<a2>, b2:<b2>, a0:<a0> Filter3: a1:<a1>, b1:<b1>, a2:<a2>, b2:<b2>, a0:<a0> Filter4: a1:<a1>, b1:<b1>, a2:<a2>, b2:<b2>, a0:<a0> Filter5: a1:<a1>, b1:<b1>, a2:<a2>, b2:<b2>, a0:<a0> Filter6: a1:<a1>, b1:<b1>, a2:<a2>, b2:<b2>, a0:<a0> Filter7: a1:<a1>, b1:<b1>, a2:<a2>, b2:<b2>, a0:<a0> Filter8: a1:<a1>, b1:<b1>, a2:<a2>, b2:<b2>, a0:<a0> [...] (for all the supported paths) OK	+UDBF: Path 0: Filter1: a1:0, b1:0, a2:0, b2:0, a0:32767 Filter2: a1:0, b1:0, a2:0, b2:0, a0:32767 Filter3: a1:0, b1:0, a2:0, b2:0, a0:32767 Filter4: a1:0, b1:0, a2:0, b2:0, a0:32767 Filter5: a1:0, b1:0, a2:0, b2:0, a0:32767 Filter6: a1:0, b1:0, a2:0, b2:0, a0:32767 Filter7: a1:0, b1:0, a2:0, b2:0, a0:32767 Filter8: a1:0, b1:0, a2:0, b2:0, a0:32767 [repeated for each path] OK
Test	AT+UDBF=?	+UDBF: (list of supported <downlinkpath_num>s),(list of supported <filter_number>s),(list of supported <a1>s),(list of supported <b1>s),(list of supported <a2>s),(list of supported <b2>s),(list of supported <a0>s) OK	+UDBF: (0-9),(1-8),(-32768:32767),(-32768:32767),(-32768:32767),(-32768:32767) OK

22.6.3 Defined values

Parameter	Type	Description
<downlinkpath_num>	Number	Specifies the downlink path where the digital filters must be configured. For downlink paths range and physical meaning, see the product specific section in the Chapter 22.1 : <ul style="list-style-type: none"> LEON-G series: Chapter 22.1.1 SARA-G340 / SARA-G350: Chapter 22.1.2 LISA-U120 / LISA-U130: Chapter 22.1.3 LISA-U2 series: Chapter 22.1.4 SARA-U series: Chapter 22.1.5
<filter_number>	Number	On LEON-G1 series: two digital biquad filters in cascade are available for each uplink path (Filter1, Filter2). See the Chapter 22.1.1 for the filter position. The range goes from 1 to 2. On SARA-G350 / SARA-G340 series: two digital biquad filters in cascade are available for each uplink path (Filter1, Filter2). See the Chapter 22.1.2 for the filter position. The range goes from 1 to 2. On LISA-U1 series: four digital biquad filters in cascade are available for each downlink path. See the Chapter 22.1.3 for the filter position. Filters 1-4 are used for Narrow Band speech (8 kHz sampling rate i.e. with HR, FR, EFR, NB-AMR codec). Filters 1-5 are used for Wide Band speech (16 kHz sampling rate i.e. with WB-AMR). The range goes from 1 to 8. On LISA-U2 / SARA-U series: four digital biquad filters in cascade are available for each downlink path. See the Chapter 22.1.4 for the filter position on LISA-U2 and to Chapter 22.1.5 for the filter position on SARA-U. Filters 1-4 are used for Narrow Band speech (8 kHz sampling rate i.e. with HR, FR, EFR, NB-AMR codec). Filters 1-5 are used for Wide Band speech (16 kHz sampling rate i.e. with WB-AMR). The range goes from 1 to 8.
<a1>,<b1>,<a2>,<b2>,<a0>	Number	Biquad filter coefficient. The range goes from -32768 to 32767. The factory-programmed value for a1, b1, a2 and b2 is 0 and for a0 is 32767.

22.6.4 Notes

The biquad filter transfer function is

$$H(z) = \frac{A_0 + 2A_1 z^{-1} + A_2 z^{-2}}{1 + 2B_1 z^{-1} + B_2 z^{-2}}$$

with coefficients A_0, A_1, A_2, B_1, B_2 in the range $-1:1$

Command parameters are filter coefficients scaled in the range that goes from -32768 to 32767

- $\langle a1 \rangle = 32767 * A_1$
- $\langle b1 \rangle = 32767 * B_1$
- $\langle a2 \rangle = 32767 * A_2$
- $\langle b2 \rangle = 32767 * B_2$
- $\langle a0 \rangle = 32767 * A_0$

For the computation of the coefficients, consider the following sampling rate for each product (according to speech codec in use, as explained in [Chapter 22.1](#)).

SARA-G350 / SARA-G340

- 8 kHz sampling rate. Filters are 'Narrow Band'(0 - 4 kHz)

LEON-G

- 8 kHz sampling rate. Filters are 'Narrow Band'(0 - 4 kHz)
- The factory-programmed values are as follows:
 - o Path 0:
 - Filter1: $a1=0, b1=0, a2=0, b2=0, a0=32767$
 - Filter2: $a1=0, b1=0, a2=0, b2=0, a0=32767$
 - o Path 1:
 - Filter1: $a1=-29322, b1=-29141, a2=29322, b2=26240, a0=29322$
 - Filter2: $a1=29322, b1=29141, a2=29322, b2=26240, a0=29322$
 - o Path 3:
 - Filter1: $a1=0, b1=0, a2=0, b2=0, a0=32767$
 - Filter2: $a1=0, b1=0, a2=0, b2=0, a0=32767$
 - o Path 4:
 - Filter1: $a1=0, b1=0, a2=0, b2=0, a0=32767$
 - Filter2: $a1=0, b1=0, a2=0, b2=0, a0=32767$

LISA-U1 / LISA-U2 / SARA-U

- 8 kHz sampling rate for $\langle \text{filter_number} \rangle = (1-4)$. These filters are used when speech codec is HR, FR, EFR or NB-AMR (speech sampling rate is 8 kHz), thus filters are 'Narrow Band' (0 - 4 kHz).
- 16 kHz sampling rate for $\langle \text{filter_number} \rangle = (5-8)$. These filters are used when speech codec is WB-AMR (speech sampling rate is 26 kHz), thus filters are 'Wide Band' (0 - 8 kHz).

Example:

Set both loudspeaker filters to all pass:

In this case the biquad filter transfer function is

$$H(z)=1$$

Then the coefficients are

$$A0=1$$

A1=A2=B1=B2=0

Thus parameters are: <a1>=0 ,<b1> =0 ,<a2>=0 ,<b2>= 0 ,<a0>=32767

Commands are:

AT+UDBF=3,1,0,0,0,0, 32767

AT+UDBF=3,2,0,0,0,0, 32767

22.7 Hands-Free Parameters (Hands-Free Parameters) +UHFP

+UHFP						
Modules	LEON-G SARA-G340 SARA-G350 LISA-U120 LISA-U130 LISA-U200-01S LISA-U200-02S LISA-U200-52S LISA-U200-62S LISA-U200-82S LISA-U230 LISA-U260 LISA-U270 SARA-U					
Attributes	Syntax	PIN required	Settings saved	Can be aborted	Response time	Error reference
	partial	No	<i>Profile</i>	No	-	+CME Error

22.7.1 Description

Sets the parameters that control the hands-free audio application for a specific uplink path. The hands-free application consists of:

- Echo Canceller (EC)
- Automatic Gain Control (AGC)
- Noise Reduction (NR)



The corresponding module Audio Application Note describes in detail the HF algorithm tuning.

The command syntax differs between different module series. In [Chapter 22.7.2](#) and [Chapter 22.7.4](#) the different descriptions are provided.

22.7.2 Command syntax for LEON-G series

Type	Syntax	Response	Example
Set	AT+UHFP=<uplink_path_num>,<hf_algorithm_init>,<hf_algorithm_restart>,<step_width>,<lms_length>,<lms_offset>,<block_length>,<rxtx_relation>,<add_atten>,<min_atten>,<max_atten>,<nr_sw_2>,<nr_u_fak_0>,<nr_u_fak>	OK	AT+UHFP=1,0x01FD,0x016E,2200,250,3,5,150,0,0,500,4096,16384,16384 OK
Read	AT+UHFP?	+UHFP: Path <uplink_path_num>: HF_algorithm_init:<hf_algorithm_init>, HF_Algorithm_Restart:<hf_algorithm_restart>, Step_Width:<step_width>, LMS_Length:<lms_length>, LMS_Offset:<lms_offset>, Block_Length:<block_length>, RXTX_Relation:<rxtx_relation>, Add_Atten:<add_atten>, Min_Atten:<min_atten>, Max_Atten:<max_atten>,<nr_sw_2>:<nr_sw_2>,<nr_u_fak_0>:<nr_u_fak_0>,<nr_u_fak_0>,<nr_u_fak_0>,<nr_u_fak_0> [...] (for all the supported paths) OK	+UHFP: Path 0: HF_algorithm_init:0x01fd, HF_Algorithm_Restart:0x016e, Step_Width:2200, LMS_Length:250, LMS_Offset:3, Block_Length:5, RXTX_Relation:150, Add_Atten:0, Min_Atten:0, Max_Atten:500, NR_sw_2:4096, NR_u_fak_0:16384, NR_u_fak:16384 Path 1: HF_algorithm_init:0x01fd, HF_Algorithm_Restart:0x016e, Step_Width:2200, LMS_Length:250, LMS_Offset:3, Block_Length:5, RXTX_Relation:150, Add_Atten:0, Min_Atten:0, Max_Atten:500, NR_sw_2:4096, NR_u_fak_0:16384, NR_u_fak:16384 Path 2:



Type	Syntax	Response	Example
			HF_algorithm_init:0x01fd, HF_Algorithm_Restart:0x016e, Step_Width:2200, LMS_Length:250, LMS_Offset:8, Block_Length:5, RXTX_Relation:150, Add_Atten:0, Min_Atten:0, Max_Atten:500, NR_sw_2:4096, NR_u_fak_0:16384, NR_u_fak:16384 OK
Test	AT+UHFP=?	+UHFP: (list of supported <uplink_path_num>s),(list of supported <hf_algorithm_init>s),(list of supported <hf_algorithm_restart>s),(list of supported <step_width>s),(list of supported <lms_length>s),(list of supported <lms_offset>s), (list of supported <block_length>s),(list of supported <rxtx_relation>s),(list of supported <add_atten>s),(list of supported <min_atten>s), (list of supported <max_atten>s),(list of supported <nr_sw_2>s),(list of supported <nr_u_fak_0>s),(list of supported <nr_u_fak>s) OK	+UHFP: (0-2),(0x0000-0x01FF),(0x0000-0x01FF),(0:32767),(2:400),(0:400), (2,4,5,8),(-960:+960),(0:960),(0:960),(0:960),(0:32767),(0:16384),(0:16384) OK

22.7.3 Defined values for LEON-G series

Parameter	Type	Description
<uplink_path_num>	Number	<ul style="list-style-type: none"> 0: handset_mic 1: headset_mic 2: I2S_rx
<hf_algorithm_init>	Number	<p>The SWITCH parameter controls the activity and the initialization of the EC, AGC, NR blocks</p> <ul style="list-style-type: none"> Bit#0 set: Echo Canceller (EC) initialization Bit#1 set: ECrestart (without coefficient initialization) Bit#2 set: EC on Bit#3 set: EC adaptation on Bit#4 set: noise reduction initialization Bit#5 set: noise reduction on Bit#6 set: noise reduction works with additional AGC Bit#7 set: automatic Gain Control (AGC) initialization Bit#8 set: AGC on <p>Setting the bits is not mutually exclusive; more than one bit can be set at the same time.</p> <ul style="list-style-type: none"> Range: 0x0000 to 0x01FF (hexadecimal format only)
<hf_algorithm_restart>	Number	<p>This bit mask allows to restart the activity of the EC, AGC, NR blocks without initialization. For the bit map see the <hf_algorithm_init>. It is used when the algorithm is automatically restarted by the driver (i.e. after a handover)</p> <ul style="list-style-type: none"> Range: 0x0000 to 0x01FF (hexadecimal format only)
<step_width>	Number	<p>The higher this value, the faster the echo characteristic gets adapted</p> <p>Limit: <step_width>*<block_length><=2*32767</p> <p>Range: 0 to 32767</p>
<lms_length>	Number	<p>Maximum impulsive response of the FIR filter considered by the adaptive LMS algorithm, in samples. (Max time length: 400*Ts=50 ms)</p> <p>Limit:</p> <p>2<= <lms_length>+ <lms_offset><=400 (DSP memory limit)</p> <p>Range: 2 to 400</p>
<lms_offset>	Number	<p>This parameter is used by the LMS adaptation algorithm and indicates the expected delay of the echo after the RX signal, in samples</p> <p>Range: 0 to 400</p>

Parameter	Type	Description
<block_length>	Number	LMS coefficient adaptation block length. The higher this number, the slower but more accurate the adaptation converges Allowed values are: 2, 4, 5, 8
<rxtx_relation>	Number	Checks the power relation between Rx (loudspeaker) and Tx (microphone) signals to recognize the double talk condition from the echo condition. The system is considered to be in double talk condition when the TX power (mic signal) is higher than the maximum expected echo power: $Tx(dB) > Rx(dB) - RxTx(dB)$ with $RxTx(dB) = <rxtx_relation> * 3/32$ This is the most critical parameter in hands-free. Values typical for handset are in range 50 to 150. For backspeaker: -100 to -400. When in double talk, the adaptation of FIR and AGC are suspended. Range: -960 to 960
<add_atten>	Number	When AGC decides to attenuate, <add_atten> is added to the calculated attenuation <ul style="list-style-type: none"> Attenuation Level(dB)=3/32* <add_atten> Range: 0 to 960
<min_atten>	Number	Minimal attenuation of the mic signal allowed for the AGC <ul style="list-style-type: none"> Attenuation Level (dB)=3/32* <min_atten> Range: 0 to 960
<max_atten>	Number	Maximal attenuation of the mic signal allowed for the AGC <ul style="list-style-type: none"> Attenuation Level (dB)=3/32* <max_atten> Range: 0 to 960
<nr_sw_2>	Number	Max NR attenuation. Linear; 32767 means 1 (0 dB) <ul style="list-style-type: none"> Ex. 16384= 0.5 = -6 dB Range: 0 to 32767
<nr_u_fak_0>	Number	Factor of NR in the band 0 (0 Hz - 250 Hz) <ul style="list-style-type: none"> Linear; 16384 means 1 (0 dB) Range: 0 to 16384
<nr_u_fak>	Number	Factor of NR in the bands 1 to 7 (250 Hz - 3750 Hz) <ul style="list-style-type: none"> Linear; 16384 means 1 (0 dB) A factor lower than 1 causes a better NR but also speech distortion and lowering of SLR. Range: 0 to 16384

Examples:

- SWITCH =0x01FD =bin 00011111101 means EC initialized and on, EC adaptation on, noise reduction initialized and on, Automatic Gain Control initialized and on, used with NR.
- SWITCH =0x016E =bin 000101101110 means EC on, EC adaptation on, EC restart noise reduction on, Automatic Gain Control on and working with NR.
- SWITCH =0x0000 means EC, AGC and NR all off.
- Calculation of <lms_offset>
Sample period $T = 1/8000$ s = 125 μ s Loudspeaker to mic distance on a phone: L= 10 cm
Sound velocity $V = 340$ m/s Delay of echo: $D = L/V = 0.1/340 = 294 \mu$ s
Number of samples= $D/T = 2.35$ --> LMS_OFFSET =2



Any change in the gain on uplink or downlink path impacts on the amount of echo fed back from the speaker to the microphone. This means that performance of EC algorithm could change and rxtx_relation parameter could need to be changed to better fit new gain on uplink or downlink path.

22.7.4 Command syntax for LISA-U / SARA-U / SARA-G350 / SARA-G340 series

Type	Syntax	Response	Example
Set	AT+UHFP=<uplink_path_num>,<hf_algorithm_init>[,<hf_algorithm_restart>[,<step_width>[,<lms_length>[,<lms_offset>[,<block_length>[,<rxtx_	OK	AT+UHFP=1,0x01Fd,,,,,0,50,450,8000,7000,7000,4,220,220,220,100,100,100 OK



Type	Syntax	Response	Example
	relation>]]]]]]],<add_atten>,<min_atten>,<max_atten>,<nr_sw_2>,<nr_u_fak_0>,<nr_u_fak>[,<ec_block_length>[, <ec_nr_coeff_real> [,<ec_nr_coeff_complex1>[,<ec_nr_coeff_complex2>[,<ec_nr_coeff_complex3>[,<ec_nr_coeff_complex4>[,<ec_nr_coeff_complex5>]]]]]]])		
Read	AT+UHFP?	+UHFP: Path <uplink_path_num>: HF_algorithm_init:<hf_algorithm_init>, HF_Algorithm_Restart:NA, Step_Width:NA, LMS_Length:NA, LMS_Offset:NA, Block_Length:NA, RXTX_Relation:NA, Add_Atten:<add_atten>, Min_Atten:<min_atten>, Max_Atten:<max_atten>, NR_sw_2:<nr_sw_2>, NR_u_fak_0:<nr_u_fak_0>, NR_u_fak:<nr_u_fak>,<ec_block_length>,<ec_nr_coeff_real>, <ec_nr_coeff_complex1>,<ec_nr_coeff_complex2>,<ec_nr_coeff_complex3>,<ec_nr_coeff_complex4>,<ec_nr_coeff_complex5> [...] (for all the supported paths) OK	+UHFP: Path 0: HF_algorithm_init:0x01fd, HF_Algorithm_Restart:NA, Step_Width:NA, LMS_Length:NA, LMS_Offset:NA, Block_Length:NA, RXTX_Relation:NA, Add_Atten:0, Min_Atten:0, Max_Atten:500, NR_sw_2:8192, NR_u_fak_0:7500, NR_u_fak:7500, EC_block_length:2, EC_nr_coeff_real:100, EC_nr_coeff_complex1:100, EC_nr_coeff_complex2:100, EC_nr_coeff_complex3:60, EC_nr_coeff_complex4:60, EC_nr_coeff_complex5:60 [...] (for all the supported paths) OK
Test	AT+UHFP=?	+UHFP: (list of supported <uplink_path_num>s),(list of supported <hf_algorithm_init>s),(list of supported <hf_algorithm_restart>s),(list of supported <step_width>s),(list of supported <lms_length>s),(list of supported <lms_offset>s), (list of supported <block_length>s),(list of supported <rxtx_relation>s),(list of supported <add_atten>s),(list of supported <min_atten>s),(list of supported <max_atten>s),(list of supported <nr_sw_2>s),(list of supported <nr_u_fak_0>s),(list of supported <nr_u_fak>s),(list of supported <ec_block_length>s), (list of supported <ec_nr_coeff_real>s), (list of supported <ec_nr_coeff_complex1>s), (list of supported <ec_nr_coeff_complex2>s), (list of supported <ec_nr_coeff_complex3>s), (list of supported <ec_nr_coeff_complex4>s), (list of supported <ec_nr_coeff_complex5>s), OK	+UHFP: (0-9),(0x0000-0x07FF),(0x0000-0x07FF),(0:32767),(2:400),(0:400),(2,4,5,8),(-960:960),(-960:960),(0:960),(0:960),(0:32767),(0:16384),(0:16384),(1,2,4,5,8),(2:2000),(1:1000),(1:1000),(1:1000),(1:1000),(1:1000) OK

22.7.5 Defined values

Parameter	Type	Description
<uplink_path_num>	Number	Specifies the uplink path where the hands free parameters must be configured. For uplink paths range and physical meaning, see the product specific section in the chapter introduction: <ul style="list-style-type: none"> SARA-G340 / SARA-G350: Chapter 22.1.2 LISA-U120 / LISA-U130: Chapter 22.1.3 LISA-U2 series: Chapter 22.1.4 SARA-U series: Chapter 22.1.5
<hf_algorithm_init>	Number	The SWITCH parameter controls the activity and initialization of the EC, AGC, NR blocks On SARA-G350 / SARA-G340 series





Parameter	Type	Description
		<ul style="list-style-type: none"> • Bit#0 set: Echo Cancellor (EC) initialization • Bit#1 set: EC restart (without coefficient initialization) • Bit#2 set: EC on • Bit#3 set: noise reduction initialization • Bit#4 set: noise reduction on • Bit#5 set: dynamic Echo Suppression INIT • Bit#6 set: dynamic Echo Suppression ACTIVE • Bit#7 set: automatic Gain Control (AGC) initialization • Bit#8 set: AGC on • Bit#9 set: reconfigure • Bit#10 set: unused • Bit#11 set: unused • Bit#12 set: Spectral Echo Reduction (SER) Initialization • Bit#13 set: SER on <p>Range: 0x0000 to 0x3FFF (hexadecimal format only).</p> <p>On LISA-U1 series</p> <ul style="list-style-type: none"> • Bit#0 set: Echo Cancellor (EC) initialization • Bit#1 set: EC restart (without coefficient initialization) • Bit#2 set: EC on • Bit#3 set: unused • Bit#4 set: noise reduction initialization • Bit#5 set: noise reduction on • Bit#6 set: unused • Bit#7 set: Automatic Gain Control (AGC) initialization • Bit#8 set: AGC on • Bit#9 set: dynamic Echo Suppression INIT • Bit#10 set: dynamic Echo Suppression ACTIVE <p>Range: 0x0000 to 0x07FF (hexadecimal format only).</p> <p>On LISA-U2 / SARA-U series</p> <ul style="list-style-type: none"> • Bit#0 set: unused • Bit#1 set: unused • Bit#2 set: Echo Cancellor (EC) initialization and on • Bit#3 set: unused • Bit#4 set: unused • Bit#5 set: Noise Reduction initialization and on • Bit#6 set: unused • Bit#7 set: unused • Bit#8 set: Automatic Gain Control (AGC) initialization and on • Bit#9 set: unused • Bit#10 set: Spectral Echo Reduction (SER) initialization and on <p>Range: 0x0000 to 0x07FF (hexadecimal format only).</p> <p>Setting the bits is not mutually exclusive; more than one bit can be set at the same time.</p>
<hf_algorithm_restart>	Number	<p>Not Available. 'NA' is provided in the test command</p> <p>In the set command, the range is checked but the value is not used</p> <p>On SARA-G340 / SARA-G350: the range goes from 0x0000 to 0x03FF (hexadecimal format only)</p> <p>On LISA-U/SARA-U: the range goes from 0x0000 to 0x07FF (hexadecimal format only)</p>
<step_width>	Number	<p>Not Available. 'NA' is provided in the test command.</p> <ul style="list-style-type: none"> • In the set command, the range is checked but the value is not used • Range: 0 to 32767
<lms_length>	Number	<p>Not Available. 'NA' is provided in the test command.</p> <ul style="list-style-type: none"> • In the set command, the range is checked but the value is not used • Range: 2 to 400
<lms_offset>	Number	<p>Not Available. 'NA' is provided in the test command.</p> <ul style="list-style-type: none"> • In the set command, the range is checked but the value is not used



Parameter	Type	Description
		<ul style="list-style-type: none"> Range: 0 to 400
<block_length>	Number	Not Available. 'NA' is provided in the test command. <ul style="list-style-type: none"> In the set command, the range is checked but the value is not used Allowed values: 2, 4, 5, 8
<rxtx_relation>	Number	Not Available. 'NA' is provided in the test command. <ul style="list-style-type: none"> In the set command, the range is checked but the value is not used Range : -960 to 960
<add_atten>	Number	When AGC decides to attenuate, <add_atten> is added to the calculated attenuation. <ul style="list-style-type: none"> Attenuation Level(dB)=0,05* <add_atten> Range: -960 to 960
<min_atten>	Number	Minimal attenuation of the mic signal allowed for the AGC. <ul style="list-style-type: none"> Attenuation Level(dB)=0,05* <min_atten> Range: 0 to 960
<max_atten>	Number	Maximal attenuation of the mic signal allowed for the AGC. <ul style="list-style-type: none"> Attenuation Level(dB)=0,05* <max_atten> Range: 0 to 960
<nr_sw_2>	Number	Max NR attenuation. Linear; 32767 means 1 (0 dB). <ul style="list-style-type: none"> Ex. $16384 = 0.5 = -6$ dB Range: 0 to 32767
<nr_u_fak_0>	Number	Factor of NR in the band 0 (0 Hz - 500 Hz). <ul style="list-style-type: none"> Linear; 16384 means 1 (0 dB) Range: 0 to 16384
<nr_u_fak>	Number	Factor of NR in the higher bands ($f > 500$ Hz). <ul style="list-style-type: none"> Linear; 16384 means 1 (0 dB) A factor lower than 1 causes a better NR but also speech distortion and lowering of SLR. Range: 0 to 16384
<ec_block_length>	Number	LMS coefficient adaptation block length. The higher this number, the slower but more accurate the adaptation converges. Allowed values are: 1, 2, 4, 5, 8.
<ec_nr_coeff_real>	Number	Number of coefficients of the filter in the sub-band EC, for real sub band (in Narrow Band mode: 0-0.8 kHz in Wide Band mode: 0-0.73 kHz) <ul style="list-style-type: none"> Range: 2 to 1100 (LISA-U1 series) Range: 2 to 2000 (LISA-U2 / SARA-U series) Range: 0 to 1100 (SARA-G350 / SARA-G340 series) Limit on SARA-G350 / SARA_G340 series: $\langle ec_nr_coeff_real \rangle + 2 * (\langle ec_nr_coeff_complex1 \rangle + \langle ec_nr_coeff_complex2 \rangle) < 1100$ Limit on LISA-U / SARA-U series: $\langle ec_nr_coeff_real \rangle + 2 * (\langle ec_nr_coeff_complex1 \rangle + \langle ec_nr_coeff_complex2 \rangle + \langle ec_nr_coeff_complex3 \rangle + \langle ec_nr_coeff_complex4 \rangle + \langle ec_nr_coeff_complex5 \rangle) < 2000$
<ec_nr_coeff_complex1>	Number	Number of coefficients of the filter in the sub-band EC, for complex sub band 1 (in Narrow Band mode: 0.8-2.4 kHz; in Wide Band mode: 0.73-2.18 kHz) <ul style="list-style-type: none"> Range: 1 to 1100 (LISA-U1 series) Range: 1 to 1000 (LISA-U2 / SARA-U series) Range: 0 to 1100 (SARA-G350 / SARA-G340 series) See the <ec_nr_coeff_real> parameter description for the limit value.
<ec_nr_coeff_complex2>	Number	Number of coefficients of the filter in the sub-band EC, for complex sub band 2 (in Narrow Band mode: 2.4-4 kHz; in Wide Band mode: 2.18-3.64 kHz) <ul style="list-style-type: none"> Range: 1 to 1100 (LISA-U1 series) Range: 1 to 1000 (LISA-U2 / SARA-U series) Range: 0 to 1100 (SARA-G350 / SARA-G340 series) See the <ec_nr_coeff_real> parameter description for the limit value.
<ec_nr_coeff_complex3>	Number	Number of coefficients of the filter in the sub-band EC, for complex sub band 3 (in Narrow Band mode: ignored; in Wide Band mode: 3.64-5.09 kHz) <ul style="list-style-type: none"> Range: 1 to 1100 (LISA-U1 series)

Parameter	Type	Description
		<ul style="list-style-type: none"> Range: 1 to 1000 (LISA-U2 / SARA-U series) On SARA-G350 / SARA-G340 series the parameter is not in use and is set to its default value (0). See the <code><ec_nr_coeff_real></code> parameter description for the limit value.
<code><ec_nr_coeff_complex4></code>	Number	Number of coefficients of the filter in the sub-band EC, for complex sub band 4 (in Narrow Band mode: ignored; in Wide Band mode: 5.09-6.56 kHz) <ul style="list-style-type: none"> Range: 1 to 1100 (LISA-U1 series) Range: 1 to 1000 (LISA-U2 / SARA-U series) On SARA-G350 / SARA-G340 series the parameter is not in use and is set to its default value (0). See the <code><ec_nr_coeff_real></code> parameter description for the limit value.
<code><ec_nr_coeff_complex5></code>	Number	Number of coefficients of the filter in the sub-band EC, for complex sub band 5 (in Narrow Band mode: ignored; in Wide Band mode: 6.56-8 kHz) <ul style="list-style-type: none"> Range: 1 to 1100 (LISA-U1 series) Range: 1 to 1000 (LISA-U2 / SARA-U series) On SARA-G350 / SARA-G340 series the parameter is not in use and is set to its default value (0). See the <code><ec_nr_coeff_real></code> parameter description for the limit value.

 Parameters `<ec_nr_coeff_complex3>`, `<ec_nr_coeff_complex4>` and `<ec_nr_coeff_complex5>` are used only in Wide Band speech (16 kHz sampling rate i.e. with WB-AMR codec) and ignored in Narrow Band speech (8 kHz sampling rate i.e. with HR, FR, EFR, NB-AMR codec). For the supported speech codec see notes in [Chapter 22.1](#).

 Not all paths are supported, see [+USPM](#) for the supported paths.

 `<hf_algorithm_restart>`, `<step_width>`, `<lms_length>`, `<lms_offset>`, `<block_length>`, `<rxtx_relation>` parameters are maintained for back compatibility with LEON-G1 series; they are not used and optional.

Examples:

SWITCH =0x01FD =bin 00011111101 means EC initialized and on, Noise reduction initialized and on, Automatic Gain Control initialized and on

SWITCH =0x0000 means EC, AGC and NR all off.

 Any change in the gain on uplink or downlink path impacts on the amount of echo fed back from the speaker to the microphone. This means that performance of Hands-Free algorithm could change and parameters could need to be changed to better fit new gain on uplink or downlink path.

23. DNS

DNS service requires the user to define and activate a connection profile, either PSD or CSD. Refer to [+UCSD](#), [+UCSDA](#) and [+UCSND](#) AT commands for establishing a CSD connection and to [+UPSD](#), [+UPSDA](#) and [+UPSND](#) AT commands for establishing a PSD connection.

When this command reports an error which is not a +CME ERROR, the error class and code is provided through [+USOER](#) AT command.

23.1 Resolve Name / IP Number through DNS +UDNSRN

+UDNSRN						
Modules	LEON-G SARA-G340 SARA-G350					
	LISA-U SARA-U					
Attributes	Syntax	PIN required	Settings saved	Can be aborted	Response time	Error reference
	full	No	No	No	< 30s	TCP/UDP/IP Error

23.1.1 Description

Translates a domain name to an IP address or an IP address to a domain name by using an available DNS. There are two available DNSs, primary and secondary. The network usually provides them after the GPRS activation or the CSD establishment. They are automatically used in the resolution process if available. The resolver will use first the primary DNS, otherwise if there is no answer, the second DNS will be involved. The user can replace each network provided DNS by setting its own DNS. In this case the command AT+UPSD should be used for a PSD context or the AT+UCSD command for the CSD context. If a DNS value different from "0.0.0.0" is provided, the user DNS will replace the correspondent network-provided one.

Usage of the network provided DNSs is recommended.



Pay attention to the DNS setting for the different profiles since the user DNS can be put into action if the corresponding profile is activated (if the user sets a DNS for a profile, and a different profile is activated, the user DNS has no action and the network DNS is used if available).

23.1.2 Syntax

Type	Syntax	Response	Example
Set	AT+UDNSRN=<resolution_type>,<domain_ip_string>	+UDNSRN: <resolved_ip_address> OK or +UDNSRN: <resolved_domain_name> OK	AT+UDNSRN=0,"www.google.com" +UDNSRN: "216.239.59.147" OK

23.1.3 Defined values

Parameter	Type	Description
<resolution_type>	Number	Type of resolution operation <ul style="list-style-type: none"> • 0: domain name to IP address • 1: IP address to domain name (host by name)
<domain_ip_string>	String	Domain name (resolution_type=0) or the IP address in (resolution_type=1) to be resolved
<resolved_ip_address>	String	Resolved IP address corresponding to the specified domain name
<resolved_domain_name>	String	Resolved domain name corresponding to the provided IP address

23.2 Dynamic DNS update +UDYNDNS

+UDYNDNS						
Modules	SARA-G340 SARA-G350 LISA-U200-02S LISA-U200-52S LISA-U200-62S LISA-U200-82S LISA-U260-02S LISA-U270-02S LISA-U270-62S SARA-U					
Attributes	Syntax	PIN required	Settings saved	Can be aborted	Response time	Error reference
	full	No	<i>NVM</i>	No	- (except URC)	<i>DynDNS Error</i> <i>+CME Error</i>

23.2.1 Introduction

The IP address assigned to a module by the network provider is often dynamic; this means the IP address changes every time a PDP context is enabled.

This could be a problem when it is needed to identify an internet host with a domain name, because they are usually used with static IP address that never changes (or rarely changes).

To solve this problem, the dynamic DNS services provide a way to assign a domain name to a host that owns a dynamic IP address, but they require a client that sends the latest IP given by the network to these services, to update their DNS tables.

With the +UDYNDNS command u-blox cellular modules can access to dynamic DNS services.

This functionality is disabled by default, but once configured and enabled it automatically sends updates to the configured Dynamic DNS service every time the module IP address change. The functionality only works for internal PDP context (see [Chapter 17.35](#)).

23.2.2 Description

Sets up the dynamic DNS client functionality. This command is part of the internal TCP/IP stack so it only works for internal PDP contexts (managed by +UPSD and +UPSDA command; refer to [Chapter 17.35](#)).





The command configuration is stored into the NVM: if enabled, it automatically works after a reboot.

The following dynamic DNS providers are supported:

- TZO.com
- DynDNS.org
- DynDNS.it
- No-IP.org
- DNSDynamic.org

During the service subscription phase the dynamic DNS provider gives a domain name, a username and a password that the AT application will use later.

If the DYNDNS client is enabled when an internal PDP connection is already active, the DYNDNS client starts working on the next PDP context activation.

-  This functionality is only available for the PDP context enabled with +UPSDA command.
-  Before changing the dynamic DNS client configuration it is required to stop (deactivate) it. Any attempt to reconfigure an already running DNS client raises an error.
-  The dynamic DNS update is not allowed during the first 60 s after module power on. If a PDP connection is established before this time, a URC notifies that the update has been delayed. In this case the update is performed once the 60 s are elapsed.
-  The dynamic DNS protocol does not allow more than one update every 60 s, anyhow the module's DYNDNS client will respect specific timing rules depending on the selected provider policies.
-  Due to the various caches involved in the DNS resolution process, the time since the DNS update is done until it is available for a user, can significantly change among different internet providers.



23.2.3 Syntax

Type	Syntax	Response	Example
Set	AT+UDYNDNS=<on_off>[,<service_id>,<domain_name>,<username>,<password>]	OK	Enable the dynamic DNS client using the TZO DNS service and the domain name "remote001.tzo.net". AT+UDYNDNS=1,0,"remote001.tzo.net","dummy_username","dummy_password" OK Disable the dynamic DNS client: AT+UDYNDNS=0 OK
Read	AT+UDYNDNS?	+UDYNDNS: <on_off>,<service_id>,<domain_name>,<username>,<password> OK	+UDYNDNS: 1,0,"remote001.tzo.net","dummy_username","dummy_password" OK
Test	AT+UDYNDNS=?	+UDYNDNS: (list of supported <on_off>), (list of supported <service_id>),<domain_name>,<username>,<password> OK	+UDYNDNS: (0-1),(0-4),"domain_name","username","password" OK
URC		+UUDYNDNS: <status>,<code>	+UUDYNDNS: 1,0

23.2.4 Defined values

Parameter	Type	Description
<on_off>	Number	Enable / Disable the dynamic DNS client <ul style="list-style-type: none"> • 0 (factory-programmed value): disable the client • 1: enable the client
<service_id>	Number	Indicates which dynamic DNS service provider to use <ul style="list-style-type: none"> • 0 (factory-programmed value): TZO.com • 1: DynDNS.org • 2: DynDNS.it • 3: No-IP.org • 4: DynamicDNS.org Mandatory parameter with <on_off >=1, not allowed with <on_off >=0
<domain_name>	String	Indicates which domain name should be associated with the module IP address. The dynamic DNS service provider provides this value. Maximum length: 64 bytes Mandatory parameter with <on_off >=1, not allowed with <on_off >=0 The factory-programmed value is an empty string
<username>	String	The username used for the client authentication Maximum length: 64 charaters Mandatory parameter with <on_off >=1, not allowed with <on_off >=0 The factory-programmed value is an empty string
<password>	String	The password used for the client authentication. Maximum length: 32 charaters Mandatory parameter with <on_off >=1, not allowed with <on_off >=0 The factory-programmed value is an empty string
<status>	Integer	This is the internal status of the dynamic DNS client. Each time the internal status changes or there is an error the URC +UUDYNDNS is issued <ul style="list-style-type: none"> • 0: client inactive/stopped • 1: client enabled/active • 2: DNS update successfully executed • 3: DNS update failed • 4: DNS update delayed



Parameter	Type	Description
		<ul style="list-style-type: none"> 5: No DNS update is required 6: Self deactivation: the dynamic DNS client will stop due to internal error or DynDNS protocol specification
<code>	Integer	This is the code returned by the +UUDYNDNS URC. The meaning of the <code> value is described in Dynamic DNS unsolicited indication codes (see Appendix A.4)

23.2.5 Notes

- In case of self deactivation (+UUDYNDNS status = 6), the client is disabled (saving the disabled setting into the NVM); the customer has then to identify the cause (usually bad configuration of the client) and manually re-activate it. After a self deactivation it is always required to re-activate the client.

23.2.6 DynDNS client behavior in case of error

When the error code is in range 1-10 and 100-108 the client waits for 60 s before allowing any update operation.

In all the other cases (error in range from 40 to 57) the following behaviors are applied:

For TZO.com:

DynDNS Client error code	Provider Error code	Client action
40	200	Next update will be possible after 60 s
41	304	Next update will be possible after 10 minutes
45	401	Client self deactivation
53	403	Client self deactivation
55	414	Next update will be possible after 60 s
46	405	Client self deactivation
54	407	Client self deactivation
56	415	Client self deactivation
57	480	Next update will be possible after 24 hours

For DynDNS.org, DynDNS.it, No-IP.org and DNSDynamic.org:

DynDNS Client error code	Provider Error code	Client action
40	good	Next update will be possible after 60 s
41	nochg	Next update will be possible after 10 minutes
45	badauth	Next update will be possible after 24 hours
47	!donator	Next update will be possible after 24 hours
42	notfqdn	Client self deactivation
43	nohost	Client self deactivation
44	numhost	Client self deactivation
48	abuse	Client self deactivation
46	badagent	Client self deactivation
49	dnserr	Next update will be possible after 30 minutes
50	911	Next update will be possible after 30 minutes
51	badsys	Client self deactivation
52	!yours	Client self deactivation

24. TCP/IP UDP/IP

24.1 Introduction

Before using TCP/IP services, a connection profile (either PSD or CSD) must be defined and activated. Refer to [+UCSD](#), [+UCSDA](#) and [+UCSND](#) AT commands for establishing a CSD connection and to [+UPSD](#), [+UPSDA](#) and [+UPSND](#) AT commands for establishing a PSD connection. The sockets can be managed independently and simultaneously over the same bearer (either PSD or CSD). AT commands for both reading and writing data on sockets are provided and the URC notifies the external application of incoming data and transmission result, no need for polling.

When these commands report an error which is not a +CME ERROR, the error code can be queried using the [+USOER](#) or [+USOCTL](#) (specifying the socket ID and with <param_id>=1) AT commands.

The maximum number of sockets that can be managed are 7.



LEON-G

The maximum number of sockets that can be managed are 16.



Some network operators close dynamic NATs after few minutes if there is no activity on the connection (no data transfer in the period). To solve this problem enable the TCP keep alive options with 1 minute delay (view [+USOSO](#) command).



When both TCP and UDP socket are used at the same time at the maximum throughput (downlink and uplink at the maximum allowed baud rate) it is possible to lose some incoming UDP packets due to internal buffer limitation. A possible workaround is provided as follows:

- If it is possible, adopt an application layer UDP acknowledge system
- On LEON-G1 series, stop sending TCP packet (and check with the [+USOCTL](#) command that the outgoing buffer is empty) when expecting to receive UDP data



LEON-G

IP dotted notation does not support a leading 0 in an IP address (e.g. IP = 010.128.076.034 is not supported, 10.128.76.34 is supported).



LEON-GThe [+UPING](#) command uses the TCP/IP resources in an exclusive way. All the other TCP/IP operations executed after the execution of the [+UPING](#) AT command will wait for the execution of this command.

24.2 Create Socket +USOCR

+USOCR						
Modules	LEON-G SARA-G340 SARA-G350					
	LISA-U SARA-U					
Attributes	Syntax	PIN required	Settings saved	Can be aborted	Response time	Error reference
	partial	No	No	No	-	TCP/UDP/IP Error +CME Error

24.2.1 Description

Creates a socket and associates it with the specified protocol (TCP or UDP), returns a number identifying the socket. Such command corresponds to the BSD socket routine. Up to 7 sockets can be created. It is possible to specify the local port to bind within the socket in order to send data from a specific port. The bind functionality is supported only for UDP sockets.



The socket creation operation can be performed only after the PDP context activation on one of the defined profiles.



LEON-G

Up to 16 sockets can be created.



SARA-G350 / SARA-G340

The bind functionality is available for both TCP and UDP sockets.

24.2.2 Syntax

Type	Syntax	Response	Example
Set	AT+USOCR=<protocol>[,<local_port>]	+USOCR: <socket> OK	AT+USOCR=17 +USOCR: 2 OK

24.2.3 Defined values

Parameter	Type	Description
<protocol>	Number	<ul style="list-style-type: none"> 6: TCP 17: UDP
<socket>	Number	Socket identifier to be used for any future operation on that socket. The range goes from 0 to 6
<local_port>	Number	Local port to be used while sending data. The range goes from 1 to 65535.

24.2.4 Notes

LEON-G

- The socket creation operation can be performed even if the PDP context has not been activated.
- The range of <socket> parameter goes from 0 to 15.

24.3 Set Socket Option +USOSO

+USOSO						
Modules	LEON-G SARA-G340 SARA-G350 LISA-U SARA-U					
Attributes	Syntax	PIN required	Settings saved	Can be aborted	Response time	Error reference
	full	No	No	No	-	TCP/UDP/IP Error +CME Error

24.3.1 Description

Sets the specified standard option (type of service, local address re-use, linger time, time-to-live, etc) for the specified socket, like the BSD setsockopt routine.



The parameters must be set one by one.

24.3.2 Syntax

Type	Syntax	Response	Example
Set	AT+USOSO=<socket>,<level>,<opt_name>,<opt_val>[,<opt_val2>]	OK	AT+USOSO=2,6,1,1 OK

24.3.3 Defined values

Parameter	Type	Description
<socket>	Number	Socket identifier. The range goes from 0 to 6
<level>	Number	<ul style="list-style-type: none"> 0: IP Protocol <opt_name> for IP Protocol level may be: <ul style="list-style-type: none"> 1: type of service <opt_val>: 8 bit mask that represents the flags of IP TOS. For more information refer to RFC 791 [27]. The range is 0-255. The default value is 0 2: time-to-live <opt_val>: unsigned 8 bit value representing the TTL. The range is 0-255 (the default value is 255) 6: TCP Protocol <opt_name> for TCP protocol level may be:



Parameter	Type	Description
		<ul style="list-style-type: none"> o 1: no delay option: do not delay send to coalesce packets; <opt_val>: numeric parameter, it enables/disables the "no delay" option <ul style="list-style-type: none"> - 1: enable - 0 (default value): disable o 2: keepidle option: send keepidle probes when it is idle for <opt_val> milliseconds <opt_val>: signed 32 bit numeric parameter representing the milliseconds for "keepidle" option. The range is 0-2147483647. The default value is 7200000 (2 hours) • 65535: Socket <opt_name> for socket level options may be: <ul style="list-style-type: none"> o 4: Local address re-use. <opt_val>: numeric parameter, it enables/disables "local address re-use" option. <ul style="list-style-type: none"> - 1: enable - 0 (default value): disable o 8: Keep connections alive. <opt_val>: numeric parameter, it enables/disables "keep connections alive" option. <ul style="list-style-type: none"> - 1: enable - 0 (default value): disable o 32: sending of broadcast messages. <opt_val>: Number enables/disables "sending of broadcast messages". <ul style="list-style-type: none"> - 1: enable - 0 (default value): disable o 128: linger on close if data present. <opt_val>: numeric parameter, it sets on/off the "linger" option. <ul style="list-style-type: none"> - 1: enable - 0 (default value): disable
		<ul style="list-style-type: none"> o <opt_val2>: signed 16 bit numeric parameter, it sets the linger time, the range goes from 0 to 32767 in milliseconds. The default value is 0. o 512: local address and port re-use. <opt_val>: numeric parameter, it enables/disables the "local address and port re-use". <ul style="list-style-type: none"> - 1: enable - 0 (default value): disable

24.3.4 Notes

LEON-G

- The range of <socket> parameter goes from 0 to 15.

24.4 Get Socket Option +USOGO

+USOGO						
Modules	LEON-G SARA-G340 SARA-G350					
	LISA-U SARA-U					
Attributes	Syntax	PIN required	Settings saved	Can be aborted	Response time	Error reference
	full	No	No	No	-	TCP/UDP/IP Error +CME Error

24.4.1 Description

Retrieves the specified standard option (type of service, local address re-use, linger time, time-to-live, etc) for the specified socket, like the BSD getsockopt routine.

24.4.2 Syntax

Type	Syntax	Response	Example
Set	AT+USOGO=<socket>,<level>,<opt_name>	+USOGO: <opt_val>[,<opt_val2>] OK	AT+USOGO=0,0,2 +USOGO: 255 OK



24.4.3 Defined values

Parameter	Type	Description
<socket>	Number	Socket identifier. The range goes from 0 to 6
<level>	Number	<ul style="list-style-type: none"> • 0: IP Protocol <opt_name> for IP Protocol level may be: <ul style="list-style-type: none"> o 1: type of service <opt_val>: 8 bit mask that represents the flags of IP TOS. For more information see the RFC 791 [27]. The range is 0-255. The default value is 0 o 2: time-to-live <opt_val>: unsigned 8 bit value representing the TTL. The range is 0-255. The default value is 0. • 6: TCP Protocol <opt_name> for TCP protocol level may be: <ul style="list-style-type: none"> o 1: no delay option: do not delay send to coalesce packets <opt_val>: numeric parameter, it enables/disables the "no delay" option <ul style="list-style-type: none"> - 0 (default value): disabled - 1: enabled o 2: keepidle option: send keepidle probes when idle for <opt_val> milliseconds <opt_val>: signed 32 bit number value representing the milliseconds for "keepidle" option. The range 0-2147483647. The default value is 7200000 (2 hours) • 65535: socket <opt_name> for the socket level options may be: <ul style="list-style-type: none"> o 4: local address re-use <opt_val>: numeric parameter, it configures the "local address re-use" option: <ul style="list-style-type: none"> - 0 (default value): disabled - 1: enabled o 8: keep connections alive <opt_val>: numeric parameter, it configures the "keep connections alive" option: <ul style="list-style-type: none"> - 0 (default value): disabled - 1: enabled o 32: sending of broadcast messages <opt_val>: numeric parameter, it configures the "sending of broadcast messages": <ul style="list-style-type: none"> - 1: enabled - 0 (default value): disabled o 128: linger on close if data present <opt_val>: numeric parameter, it sets on/off the "linger" option. <ul style="list-style-type: none"> - 0 (default value): disabled - 1: enabled <opt_val2>: signed 16 bit numeric value, linger time, the range goes from 0 to 32767 in milliseconds. The default value is 0. o 512: local address and port re-use <opt_val>: numeric parameter, it enables/disables "local address and port re-use": <ul style="list-style-type: none"> - 0 (default value): disabled - 1: enabled

24.4.4 Notes

LEON-G

- The range of <socket> parameter goes from 0 to 15.

24.5 Close Socket +USOCL

+USOCL						
Modules	LEON-G SARA-G340 SARA-G350					
	LISA-U SARA-U					
Attributes	Syntax	PIN required	Settings saved	Can be aborted	Response time	Error reference
	partial	No	No	No	< 10s (except URC)	+CME Error

24.5.1 Description

Closes the specified socket, like the BSD close routine. In case of remote socket closure the user is notified via the URC.

24.5.2 Syntax

Type	Syntax	Response	Example
Set	AT+USOCL=<socket>	OK	AT+USOCL=2 OK
URC		+UUSOCL: <socket>	+UUSOCL: 2

24.5.3 Defined values

Parameter	Type	Description
<socket>	Number	Socket identifier. The range goes from 0 to 6

24.5.4 Notes

LEON-G

- The range of <socket> parameter goes from 0 to 15.

24.6 Get Socket Error +USOER

+USOER						
Modules	LEON-G SARA-G340 SARA-G350					
	LISA-U SARA-U					
Attributes	Syntax	PIN required	Settings saved	Can be aborted	Response time	Error reference
	full	No	No	No	-	TCP/UDP/IP Error +CME Error

24.6.1 Description

Retrieves the last error occurred in the last socket operation, stored in the BSD standard variable error.

24.6.2 Syntax

Type	Syntax	Response	Example
Action	AT+USOER	+USOER: <socket_error> OK	+USOER: 104 OK

24.6.3 Defined values

Parameter	Type	Description
<socket_error>	Number	Code of the last error occurred in a socket operation. The allowed values are listed in Appendix A.3 <ul style="list-style-type: none"> 0: no error

24.7 Connect Socket +USOCO

+USOCO						
Modules	LEON-G SARA-G340 SARA-G350 LISA-U SARA-U					
Attributes	Syntax	PIN required	Settings saved	Can be aborted	Response time	Error reference
	partial	No	No	No	< 20s	TCP/UDP/IP Error +CME Error

24.7.1 Description

Establishes a peer-to-peer connection of the socket to the specified remote host on the given remote port, like the BSD connect routine. If the socket is a TCP socket, the command will actually perform the TCP negotiation (3-way handshake) to open a connection. If the socket is a UDP socket, this function will just declare the remote host address and port for later use with other socket operations (e.g. +USOWR, +USORD). This is important to note because if <socket> refers to a UDP socket, errors will not be reported prior to an attempt to write or read data on the socket.

24.7.2 Syntax

Type	Syntax	Response	Example
Set	AT+USOCO=<socket>,<remote_addr>,<remote_port>	OK	AT+USOCO=3,"151.63.16.9",1200 OK

24.7.3 Defined values

Parameter	Type	Description
<socket>	Number	Socket identifier. The range goes from 0 to 6
<remote_addr>	String	Remote host IP address in dotted decimal notation form (i.e. four numbers in range 0-255 separated by periods) or domain name of the remote host
<remote_port>	Number	Remote host port, in range 1-65535

24.7.4 Notes

LEON-G

- The range of <socket> parameter goes from 0 to 15.

24.8 Write Socket Data +USOWR

+USOWR						
Modules	LEON-G SARA-G340 SARA-G350 LISA-U SARA-U					
Attributes	Syntax	PIN required	Settings saved	Can be aborted	Response time	Error reference
	partial	No	No	No	< 10s	TCP/UDP/IP Error +CME Error

24.8.1 Description

Writes the specified amount of data to the specified socket, like the BSD write routine, and returns the number of bytes of data actually written. Applied to UDP sockets too, after a +USOCO Connect Socket command.

There are three kinds of syntax:





- Base syntax normal: writing simple strings to the socket, there are characters which are forbidden
- Base syntax HEX: writing hexadecimal strings to the socket, the string will be converted in binary data and sent to the socket
- Binary extended syntax: mandatory for writing any character in the ASCII range [0x00, 0xFF]



(about TCP socket): if no network signal is available, the TCP packets are enqueued until the network will become available again. If the TCP queue is full the +USOWR command will return error. To get the



last socket error use the **+USOCTL** command with `<param_id>= 1`. If the error returned is 11, it means that the queue is full.

-  (about TCP socket): if the connection is closed by the remote host, the +UUSOCL indication is not sent until all received data is read using the AT+USORD command. If AT+USOWR command is used in this situation, the ERROR message is returned.
-  (about UDP socket): due to the UDP specific AT commands, it is preferred to use the **+USOST** command to send data via UDP socket. This command does not require the usage of +USOCO before sending data.
-  (about UDP socket): if no network signal is available, out going UDP packet may be lost.
-  The URC indicates that data has been sent to lower level of protocol stack. This is not an indication of an acknowledgment received by the remote server the socket is connected to.
-  To enable the base syntax HEX mode refer to the **AT+UDCONF=1** command description.

24.8.2 Syntax

Type	Syntax	Response	Example
Set (Base)	AT+USOWR=<socket>,<length>,<data>	+USOWR: <socket>,<length> OK	AT+USOWR=3,12,"Hello world!" +USOWR: 3,12 OK
Set (Binary)	AT+USOWR=<socket>,<length> After the "@" prompt <length> bytes of data are entered	@ +USOWR: <socket>,<length> OK	AT+USOWR=3,16 @16 bytes of data +USOWR: 3,16 OK

24.8.3 Defined values

Parameter	Type	Description
<socket>	Number	Socket identifier. The range goes from 0 to 6
<length>	Number	Number of data bytes to write: <ul style="list-style-type: none"> • Base syntax normal mode: range 0-512 • Base syntax HEX mode: range 0-250 • Binary extended syntax: range 0-1024
<data>	String	Data bytes to be written. Not all of the ASCII charset can be used

24.8.4 Notes

- For Base Syntax:
 - o Allowed ASCII characters: 0x20 (space), 0x21 and from 0x23 to 0xFF, all the alphanumeric set, the symbols and extended ASCII charset from 0x80 to 0xFF
 - o Forbidden: The control characters from 0x00 to 0x1F (included), 0x22 character, quotation marks (")
 - o The value of <length> and the actual length of <data> must match
 - o For base syntax HEX mode, only the ASCII characters 0-9, A-F and a-f are allowed. The length of the <data> parameter must be two times the <length> parameter
- For Binary Syntax:
 - o After the command is sent, the user waits for the @ prompt. When it appears the stream of bytes can be provided. After the specified amount of bytes has been sent, the system returns with OK (or ERROR). The feed process cannot be interrupted i.e. the return in the command mode can be effective only when the number of bytes provided is the declared one
 - o After the @ prompt reception, wait for a minimum of 50 ms before sending data.
 - o The binary extended syntax is the only way for the system to accept control characters as data; for the AT command specifications 3GPP TS 27.005 [16], characters like <CR>, <CTRL-Z>, quotation

marks, etc. have a specific meaning and they cannot be used like data in the command itself. The command is so extended with a specific acceptance state identified by the @ prompt

- o This feature can be successfully used when there is need to send a byte stream which belongs to a protocol that has any kind of characters in the ASCII range [0x00,0xFF]
- o In binary mode the module does not display the echo of data bytes
- o Binary syntax is not affected by HEX mode option
- For <data> parameter not all of the ASCII charset can be used.

LISA-U1

- The range of <length> parameter goes from 0 to 1024 in base syntax normal mode.

LEON-G

- (about TCP socket): if the connection is closed by the remote host, the +UUSOCL indication is not sent until all received data is read using the AT+USORD command. If AT+USOWR command is used in this situation, the message +USOWR: <socket>,0<CR><LF>OK is returned.
- The range of <socket> parameter goes from 0 to 15.
- For the binary syntax in binary mode the module displays the echo of data bytes.

24.9 Send To command (UDP only) +USOST

+USOST						
Modules	LEON-G SARA-G340 SARA-G350 LISA-U SARA-U					
Attributes	Syntax	PIN required	Settings saved	Can be aborted	Response time	Error reference
	full	No	No	No	< 10s	TCP/UDP/IP Error +CME Error

24.9.1 Description

Writes the specified amount of data to the remote address, like the BSD sendto routine, and returns the number of bytes of data actually written. It can be applied to UDP sockets only. This command allows the reuse of the same socket to send data to many different remote hosts.

There are three kinds of syntax:

- Base syntax normal: writing simple strings to the socket, there are characters which are forbidden
- Base syntax HEX: writing hexadecimal strings to the socket, the string will be converted in binary data and sent to the socket
- Binary extended syntax: mandatory for writing any character in the ASCII range [0x00, 0xFF]



It is strongly recommended using this command to send data while using UDP sockets. It is also recommended avoiding +USOCO usage with UDP socket.



(about UDP socket): if no network signal is available, outgoing UDP packet may be lost.



To enable the base syntax HEX mode, refer to the [AT+UDCONF=1](#) command description.

24.9.2 Syntax

Type	Syntax	Response	Example
Set (Base)	AT+USOST=<socket>,<remote_ip_address>,<remote_port>,<length>,<data>	+USOST: <socket>,<length> OK	AT+USOST=3,"151.9.34.66",449,16,"16 bytes of data" +USOST: 3,16 OK
Set (Binary)	AT+USOST=<socket>,<remote_ip_address>,<remote_port>,<length> After the "@" prompt <length> bytes of data are entered	@ +USOST: <socket>,<length> OK	AT+USOST=3,"151.9.34.66",449,16 @16 bytes of data +USOST: 3,16



Type	Syntax	Response	Example
			OK

24.9.3 Defined values

Parameter	Type	Description
<socket>	Number	Socket identifier. The range goes from 0 to 6
<remote_ip_address>	String	Remote host IP address
<remote_port>	Number	Remote host port
<length>	Number	Number of data bytes to write <ul style="list-style-type: none"> • Base syntax normal mode: range 0-1024 • Base syntax HEX mode: range 0-250 • Binary syntax mode: range 0-1024
<data>	String	Data bytes to be written (not all of the ASCII charset can be used)

24.9.4 Notes

- For Base Syntax:
 - o Allowed ASCII characters: 0x20 (space), 0x21 and from 0x23 to 0xFF. Substantially all of the alphanumeric set, symbols and extended ASCII charset from 0x80 to 0xFF
 - o Forbidden: The control characters from 0x00 to 0x1F (included), 0x22 character, quotation marks (")
 - o The value of <length> and the actual length of <data> must match
 - o For base syntax HEX mode, only ASCII characters 0-9, A-F and a-f are allowed. The length of the <data> parameter must be two times the <length> parameter
- For Binary Syntax:
 - o After the command is sent, the user waits for the @ prompt. When it appears the stream of bytes can be provided. After the specified amount of bytes has been sent, the system returns with OK (or ERROR). The feed process cannot be interrupted i.e. the return in the command mode can be effective only when the number of bytes provided is the declared one
 - o That binary extended syntax is the only way for the system to accept control characters as data; for the AT command specifications [16], characters like <CR>, <CTRL-Z>, quotation marks, etc. have a specific meaning and they cannot be used like data in the command itself. The command is so extended with a specific acceptance state identified by the @ prompt
 - o This feature can be successfully used when there is need to send a byte stream which belongs to a protocol that has any kind of characters in the ASCII range [0x00,0xFF]
 - o In binary mode the module does not display the echo of data bytes
 - o Binary syntax is not affected by HEX mode option

LEON-G / SARA-G

- The range of <length> for the base syntax is 0-512.

LEON-G

- The range of <socket> parameter goes from 0 to 15.
- For the binary syntax in binary mode the module displays the echo of data bytes.

24.10 Read Socket Data +USORD

+USORD						
Modules	LEON-G SARA-G340 SARA-G350 LISA-U SARA-U					
Attributes	Syntax	PIN required	Settings saved	Can be aborted	Response time	Error reference
	full	No	No	No	< 10s (except URC)	TCP/UDP/IP Error +CME Error



24.10.1 Description

Reads the specified amount of data from the specified socket, like the BSD read routine. This command can be used to know the total amount of unread data.

For the TCP socket type the URC **+UUSORD: <socket>,<length>** notifies the data bytes available for reading, either when buffer is empty and new data arrives or after a partial read by the user.

For the UDP socket type the URC **+UUSORD: <socket>,<length>** notifies that a UDP packet has been received, either when buffer is empty or after a UDP packet has been read and one or more packets are stored in the buffer.

In case of a partial read of a UDP packet **+UUSORD: <socket>,<length>** will show the remaining number of data bytes of the packet the user is reading.

-  (about UDP socket) Due to the UDP specific AT command, it is preferred to use the +USORF command to read data from UDP socket. +USORF command does not require the usage of +USOCO before reading data.
-  When applied to UDP active sockets if the UDP socket is not set in listening mode (see +USOLI) it will not be possible to receive any packet if a previous write operation is not performed.
-  If the HEX mode is enabled (refer to [AT+UDCONF=1](#) command) the received data will be displayed using an hexadecimal string.

24.10.2 Syntax

Type	Syntax	Response	Example
Set	AT+USORD=<socket>,<length>	+USORD: <socket>,<length>,<data in the ASCII [0x00,0xFF] range> OK	AT+USORD=3,16 +USORD: 3,16,"16 bytes of data" OK
URC		+UUSORD: <socket>,<length>	+UUSORD: 3,16

24.10.3 Defined values

Parameter	Type	Description
<socket>	Number	Socket identifier. The range goes from 0 to 6
<length>	Number	Number of data bytes <ul style="list-style-type: none"> • to read stored in buffer, in range 0-1024 in the set command • read from buffer, in range 0-1024 • stored in buffer for the URC
<data>	String	Data bytes to be read

24.10.4 Notes

- The returned data may be any ASCII character in the range [0x00,0xFF] i.e. control characters. The starting quotation marks shall not be taken into account like data; the first byte of data starts after the first quotation marks. Then the other characters are provided for a <length> amount. An application should rely on the <length> info to count the received number of characters (after the starting quotation marks) especially if any protocol control characters are expected.



- If an application deals with letter and number characters only i.e. all of the expected characters are outside the [0x00, 0x1F] range and are not quotation marks, the AT+USORD response quotation marks can be assumed to identify the start and the end of the received data packet. Always check <length> to identify the valid data stream.
- If the number of data bytes requested to be read from the buffer is bigger than the number of bytes stored in the buffer only the available amount of data bytes will be read.
- When <length>= 0, the command returns the total amount of data present in the network buffer.

Example: 23 unread bytes in the socket

```
AT+USORD=3,0
```

```
+USORD: 3,23
```

```
OK
```

- If the HEX mode is enabled, the length of <data> will be 2 times <length>.

LEON-G

- The range of <socket> parameter goes from 0 to 15.

24.11 Receive From command (UDP only) +USORF

+USORF						
Modules	LEON-G SARA-G340 SARA-G350					
	LISA-U SARA-U					
Attributes	Syntax	PIN required	Settings saved	Can be aborted	Response time	Error reference
	full	No	No	No	< 10s (except URC)	TCP/UDP/IP Error +CME Error

24.11.1 Description

Reads the specified amount of data from the specified UDP socket, like the BSD rcvfrom routine. The URC +UUSORF: <socket>,<length> (or also +UUSORD: <socket>,<length>) notifies that new data is available for reading, either when new data arrives or after a partial read by the user for the socket. This command can also return the total amount of unread data.

This command can be applied to UDP sockets only, and it can be used to read data after both +UUSORD and +UUSORF unsolicited indication.



If the HEX mode is enabled (see AT+UDCONF) the received data will be displayed using an hexadecimal string.

24.11.2 Syntax

Type	Syntax	Response	Example
Set	AT+USORF=<socket>,<length>	+UUSORF: <socket>,<length> +USORF: <socket>,<remote_ip_addr>,<remote_port>,<length>,<data in the ASCII [0x00,0xFF] range> OK	+UUSORF: 3,16 AT+USORF=3,16 +USORF: 3,"151.9.34.66",2222,16,"16 bytes of data" OK
URC		+UUSORF: <socket>,<length>	+UUSORF: 3,16

24.11.3 Defined values

Parameter	Type	Description
<socket>	Number	Socket identifier. The range goes from 0 to 6
<remote_ip_address>	String	Remote host IP address
<remote_port>	Number	Remote host port
<length>	Number	Number of data bytes to read, in range 0-1024
<data>	String	Data bytes to be read



24.11.4 Notes

- Each packet received from the network is stored in a separate buffer and the command is capable to read only a packet (or e portion of it) at time. This means that if <length> is greater than the packet size, the command will return a maximum amount of data equal to the packet size, also if there are other packets in the buffer. The remaining data (i.e. the remaining UDP packets) can be read with further reads.
- The returned data may have any kind of ASCII character in the range [0x00,0xFF] i.e. control characters too. The starting quotation marks shall not be taken into account like data; the first byte of data starts after the first quotation marks. Then the other characters are provided for a <length> amount. At the end of the length byte stream, another quotation marks followed by <CR><LF> are provided for user convenience and visualization purposes. An application should rely on the <length> info to count the received number of characters (after the starting quotation marks) especially if any protocol control characters are expected.
- If an application deals with letter and number characters only i.e. all of the expected characters are outside the [0x00, 0x1F] range and are not quotation marks, the AT+USORD response quotation marks can be assumed to identify the start and the end of the received data packet, anyway the <length> field usage to identify the valid data stream is recommended.
- When <length>= 0, the command returns the total amount of data present in the network buffer.

Example: 23 unread bytes in the socket

```
AT+USORF=3,0
```

```
+USORF: 3,23
```

```
OK
```

- If the HEX mode is enabled, the length of <data> will be 2 times <length>.

LEON-G

- The range of <socket> parameter goes from 0 to 15.

24.12 Set Listening Socket +USOLI

+USOLI						
Modules	LEON-G SARA-G340 SARA-G350 LISA-U SARA-U					
Attributes	Syntax	PIN required	Settings saved	Can be aborted	Response time	Error reference
	full	No	No	No	< 10s (except URC)	TCP/UDP/IP Error +CME Error

24.12.1 Description

Sets the specified socket in listening mode on the specified port of service, waiting for incoming connections (TCP) or data (UDP).

For **TCP sockets**, incoming connections will be automatically accepted and notified via the URC

+UUSOLI: <socket>,<ip_address>,<port>,<listening_socket>,<local_ip_address>,<listening_port>, carrying the connected socket identifier, the remote IP address and port.

For **UDP sockets**, incoming data will be notified via URC **+UUSORF: <listening_socket>,<length>**. To know from which remote IP address and port the data is coming from, use the AT+USORF command.

24.12.2 Syntax

Type	Syntax	Response	Example
Set	AT+USOLI=<socket>,<port>	OK	(TCP) AT+USOLI=2,1200 OK +UUSOLI: 3,"151.63.16.7",1403,2, "82.89.67.164",1200 (UDP)

Type	Syntax	Response	Example
			AT+USOLI=0,1182 OK +UUSORF: 0,1024
URC (TCP)		+UUSOLI: <socket>,<ip_address>,<port>,<listening_socket>,<local_ip_address>,<listening_port>	+UUSOLI: 3,"151.63.16.7",1403,0,"82.89.67.164",200
URC (UDP)		+UUSORF: <listening_socket>,<len>	+UUSORF: 1,967

24.12.3 Defined values

Parameter	Type	Description
<socket>	Number	Socket identifier. The range goes from 0 to 6
<port>	Number	Port of service, range 1-65535. Port numbers below 1024 are not recommended since they are usually reserved
<ip_address>	String	Remote host IP address (only in URC +UUSOLI)
<listening_socket>	Number	Socket identifier specified within the AT+USOLI command, indicates on which listening socket the connection has been accepted (only in +UUSOLI URC)
<local_ip_address>	String	TE IP address (only in +UUSOLI URC)
<listening_port>	Number	Listening port that has accepted the connection. This port is specified within the AT+USOLI command (only in +UUSOLI URC)
<length>	Number	Data length received on the UDP listening socket (only in +UUSORF unsolicited indication). In order to know the sender IP address and port, use the +USORF command.

24.12.4 Notes

- In case of notification via the URC +UUSOLI <port> is intended as the remote port.

LEON-G

- The range of <socket> parameter goes from 0 to 15.

24.13 Firewall control +UFRW

+UFRW						
Modules	LEON-G					
Attributes	Syntax	PIN required	Settings saved	Can be aborted	Response time	Error reference
	full	No	No	No	-	+CME Error

24.13.1 Description

Enables/disables internal firewall and controls filtering settings (i.e. define IP white list). When enabled, IP connections are accepted only if the IP address belongs to the defined IP white list.



The firewall applies for incoming connections only (i.e. listening sockets set by means of +USOLI command).

24.13.2 Syntax

Type	Syntax	Response	Example
Set	AT+UFRW=<action>[,<white_ip_addr_mask>]	OK	AT+UFRW=0 OK
Read	AT+UFRW?	+UFRW: <firewall_status>[,<white_ip_addr_mask1>[,<white_ip_addr_mask2>[,...]]] OK	
Test	AT+UFRW=?	+UFRW: (list of supported <action>s) OK	+UFRW: (0-4) OK

24.13.3 Defined values

Parameter	Type	Description
<action>	Number	<ul style="list-style-type: none"> 0: disable internal firewall. The parameter <white_ip_addr_mask> is not allowed in this case: if present error message will be returned 1: enable internal firewall. The parameter <white_ip_addr_mask> is not allowed in this case: if present error message will be returned 2: add specified IP address mask to firewall white list. The parameter <white_ip_addr_mask> is mandatory. The maximum size of firewall white list is 10 IP address masks: up to 10 different IP address masks can be added to firewall white list. 3: remove specified IP address mask from firewall white list. The parameter <white_ip_addr_mask> is mandatory 4: clear firewall white list. The parameter <white_ip_addr_mask> is not allowed in this case: if present error message will be returned
<white_ip_addr_mask>	String	white IP address mask to be applied to remote end IP address to decide if to accept or not the remote connection. The IP address mask is made up of 4 bytes of information expressed as four numbers in range 0-255 separated by periods (e.g. "xxx.yyy.zzz.www"). An incoming connection attempt from the remote end IP address <incoming_ip_addr> is accepted if matching the following criterium for at least one of the IP address masks in the firewall white list: <incoming_ip_addr> & <white_ip_addr_mask> == <incoming_ip_addr>
<firewall_status>	Number	<ul style="list-style-type: none"> 0: disabled 1: enabled

24.14 HEX mode configuration +UDCONF=1

+UDCONF=1						
Modules	LEON-G SARA-G340 SARA-G350					
	LISA-U SARA-U					
Attributes	Syntax	PIN required	Settings saved	Can be aborted	Response time	Error reference
	full	No	No	No	-	+CME Error

24.14.1 Description

Enables/disables the HEX mode for **+USOWR**, **+USOST**, **+USORD** and **+USORF** AT commands.

24.14.2 Syntax

Type	Syntax	Response	Example
Set	AT+UDCONF=1,<hex_mode_disable>	OK	AT+UDCONF=1,0 OK
Read	AT+UDCONF=1	+UDCONF: 1,<hex_mode_disable> OK	AT+UDCONF=1 +UDCONF: 1,1 OK

24.14.3 Defined values

Parameter	Type	Description
<hex_mode_disable>	Number	Enables/disables the HEX mode for +USOWR , +USOST , +USORD and +USORF AT commands. Allowed values: <ul style="list-style-type: none"> 0 (factory-programmed value): HEX mode disabled 1: HEX mode enabled

24.15 Set socket in Direct Link mode +USODL

+USODL						
Modules	LEON-G SARA-G340 SARA-G350					
	LISA-U SARA-U					
Attributes	Syntax	PIN required	Settings saved	Can be aborted	Response time	Error reference
	full	No	No	No	< 10s	+CME Error

24.15.1 Description

Establishes a transparent end to end communication with an already connected TCP or UDP socket via the serial interface. The data can be sent to the socket and can be received via the serial port: the usage of HW handshake is recommended.

The transparent TCP/UDP connection mode can be exited via the +++ sequence, entered after at least 2 s of suspension of transmission to the port. The socket will remain connected and communication can be re-established anytime.

The +UDCONF=5, +UDCONF=6, +UDCONF=7, +UDCONF=8 commands allow the configuration of UDP and TCP direct link triggers.

24.15.2 Syntax

Type	Syntax	Response	Example
Set	AT+USODL=<socket>	CONNECT	AT+USODL=0 CONNECT

24.15.3 Defined values

Parameter	Type	Description
<socket>	Number	Socket identifier. The range goes from 0 to 6

24.15.4 Notes

LISA-U1

- During a 3G connection on the UART interface, the data rate must be at least 115200 b/s.
- The +UDCONF command allows UDP direct link configuration via <udconf_cmd_id> 2 and 3.

LISA-U2x0-01S / LISA-U200-00S

- The +UDCONF command allows UDP direct link configuration via <udconf_cmd_id> 2 and 3.

LEON-G

- The UDP Direct Link is not supported.
- The range of <socket> parameter goes from 0 to 15.

24.15.5 Enhanced Direct Link

 LEON-G1 / LISA-U1 / LISA-U2x0-01S / LISA-U200-00S
Not supported.

The enhanced DL functionality allows the user set up to three kinds of trigger for data transmission:

- Timer Trigger
- Data Length Trigger
- Character Trigger

The triggers can be applied independently to each socket. A socket may be set with more than one trigger.

The trigger must be set after the socket creation and before switching to direct link mode.

By default Timer Trigger and Data Length Trigger are enabled for UDP sockets.



By default no triggers are enabled for TCP sockets.

Refer to the [+UDCONF=5](#), [+UDCONF=6](#), [+UDCONF=7](#), [+UDCONF=8](#) command description for the transmission triggers configuration.

24.15.5.1 Timer Trigger (TT)

The user can configure a timeout for sending the data. The timer starts every time a character is read from the serial interface. When the timer expires, buffered data is sent.

The timer range is between 100 and 120000 ms; the special value 0 (zero) means that the timer is disabled.

By default the timer trigger is disabled for TCP sockets and enabled with a value of 500 ms for UDP sockets.

The +UDCONF command can configure the timer trigger using `<udconf_cmd_id>=5`.

24.15.5.2 Data Length Trigger (DLT)

The user can configure a maximum buffered data length to reach before sending the data. When this length is reached the data is sent.

The minimum data length is 3, the maximum data length is 2048 bytes for TCP and 1472 bytes for UDP.

If the data length is set to 0 (zero) the trigger is disabled (every data chunk received from the serial port is immediately sent to the network).

By default the data length trigger is disabled for TCP sockets and set to 1024 for UDP sockets.

The +UDCONF command can configure the data length trigger using `<udconf_cmd_id>=6`.

24.15.5.3 Character Trigger (CT)

The user can configure a character that will trigger the data transmission. When the character is detected the data (including the trigger character) is sent.

If the specified character is -1, the character trigger is disabled.

By default it is disabled for both TCP and UDP sockets.

The +UDCONF command can configure the character trigger using `<udconf_cmd_id>=7`.

24.15.5.4 Combined Triggers

The user can enable multiple triggers together. The triggers work with an OR logic. This means that the first trigger reached fires the data transmission.

24.15.5.5 About serial data chunks

A data chunk is the amount of data that SIO recognizes as a single data transmission. On SARA-G340 / SARA-G350 / LEON-G1 series a data transmission starts when the first byte is received and it finishes when no data is received in the time required for the reception of 255 bytes at the current serial port speed.



If the baud rate is lower than 115200 b/s the time to receive 255 characters is always calculated with timings for 115200 b/s.

24.15.5.6 Data from the network

The data received from the network is immediately forwarded to the serial interface.

24.15.5.7 Congestion timer

Is it also possible to set a congestion timer after which, in case of network congestion, the module exits from direct link.

The timer range is between 1000 and 720000 ms, the special value 0 (zero) means that the timer is disabled.

By default the congestion timer is set to 60000 (60 s) for both TCP and UDP sockets.

The +UDCONF command can configure the congestion timer using `<udconf_cmd_id> = 8`.

24.16 UDP Direct Link Packet Size configuration +UDCONF=2

+UDCONF=2						
Modules	LISA-U1 LISA-U200-00S LISA-U200-01S LISA-U230 LISA-U260-01S LISA-U270-01S					
Attributes	Syntax	PIN required	Settings saved	Can be aborted	Response time	Error reference
	full	No	No	No	No	-

24.16.1 Description

Set the packet size for the UDP direct link packet.

24.16.2 Syntax

Type	Syntax	Response	Example
Set	AT+UDCONF=2,<socket_id>,<packet_size>	OK	AT+UDCONF=2,1,1024 OK
Read	AT+UDCONF=2,<socket_id>	+UDCONF: 2,<socket_id>,<packet_size> OK	AT+UDCONF=2,1 +UDCONF: 2,1,1024 OK

24.16.3 Defined values

Parameter	Type	Description
<socket_id>	Number	Socket identifier; used when changing the UDP Direct Link settings. Valid range is 0-6
<packet_size>	Number	Packet size (in bytes) for UDP direct link; valid range is 100-1472; the factory-programmed value is 1024 bytes

24.17 UDP Direct Link Sending timer configuration +UDCONF=3

+UDCONF=3						
Modules	LISA-U1 LISA-U200-00S LISA-U200-01S LISA-U230 LISA-U260-01S LISA-U270-01S					
Attributes	Syntax	PIN required	Settings saved	Can be aborted	Response time	Error reference
	full	No	No	No	No	-

24.17.1 Description

Configures the UDP direct link set sending timer.

24.17.2 Syntax

Type	Syntax	Response	Example
Set	AT+UDCONF=3,<socket_id>,<sending_timer_timeout>	OK	AT+UDCONF=3,1,1000 OK
Read	AT+UDCONF=3,<socket_id>	+UDCONF: 3,<socket_id>,<sending_timer_timeout> OK	AT+UDCONF=3,1 +UDCONF: 3,1,1000 OK

24.17.3 Defined values

Parameter	Type	Description
<socket_id>	Number	Socket identifier; used when changing the UDP Direct Link settings. Allowed range is 0-6
<sending_timer_timeout>	Number	Sending timer (in milliseconds) for UDP direct link; valid range is 100-120000; the default value is 1000 ms

24.18 Timer Trigger configuration for Direct Link +UDCONF=5

+UDCONF=5						
Modules	SARA-G340 SARA-G350 LISA-U200-02S LISA-U200-52S LISA-U200-62S LISA-U260-02S LISA-U270-02S SARA-U					
Attributes	Syntax	PIN required	Settings saved	Can be aborted	Response time	Error reference
	full	No	No	No	-	+CME Error

24.18.1 Description

Sets the timer trigger of the interested socket identifier for the data transmission enhanced Direct Link.

24.18.2 Syntax

Type	Syntax	Response	Example
Set	AT+UDCONF=5,<socket_id>,<timer_trigger>	OK	AT+UDCONF=5,0,500 OK
Read	AT+UDCONF=5,<socket_id>	+UDCONF: 5,<socket_id>,<timer_trigger> OK	AT+UDCONF=5,0 +UDCONF: 5,0,500 OK

24.18.3 Defined values

Parameter	Type	Description
<socket_id>	Number	Socket identifier; used when changing the UDP Direct Link settings. Valid range is 0-6
<timer_trigger>	Number	Enhanced Direct Link sending timer trigger (in milliseconds); valid range is 0, 100 120000; the factory-programmed value is 500 ms for UDP, 0 for TCP, 0 means trigger disabled

24.19 Data Length Trigger configuration for Direct Link +UDCONF=6

+UDCONF=6						
Modules	SARA-G340 SARA-G350 LISA-U200-02S LISA-U200-52S LISA-U200-62S LISA-U260-02S LISA-U270-02S SARA-U					
Attributes	Syntax	PIN required	Settings saved	Can be aborted	Response time	Error reference
	full	No	No	No	-	+CME Error

24.19.1 Description

Sets the data length trigger of the interested socket identifier for the data transmission enhanced Direct Link.

24.19.2 Syntax

Type	Syntax	Response	Example
Set	AT+UDCONF=6,<socket_id>,<data_length_trigger>	OK	AT+UDCONF=6,0,1024 OK
Read	AT+UDCONF=6,<socket_id>	+UDCONF: 6,<socket_id>,<data_length_trigger> OK	AT+UDCONF=6,0 +UDCONF: 6,0,1024 OK

24.19.3 Defined values

Parameter	Type	Description
<socket_id>	Number	Socket identifier; used when changing the UDP Direct Link settings. Valid range is 0-6
<data_length_trigger>	Number	Enhanced Direct Link data length trigger in bytes, valid range is 0, 3 1472 for UDP and 0, 3-2048 for TCP, the factory-programmed value is 1024 for UDP, 0 for TCP, 0 means trigger disabled

24.20 Character Trigger configuration for Direct Link +UDCONF=7

+UDCONF=7						
Modules	SARA-G340 SARA-G350 LISA-U200-02S LISA-U200-52S LISA-U200-62S LISA-U260-02S LISA-U270-02S SARA-U					
Attributes	Syntax	PIN required	Settings saved	Can be aborted	Response time	Error reference
	full	No	No	No	-	+CME Error

24.20.1 Description

Sets the character trigger of the interested socket identifier for the data transmission enhanced Direct Link.

24.20.2 Syntax

Type	Syntax	Response	Example
Set	AT+UDCONF=7,<socket_id>,<character_trigger>	OK	AT+UDCONF=7,0,13 OK
Set	AT+UDCONF=7,<socket_id>	+UDCONF: 7,<socket_id>,<character_trigger> OK	AT+UDCONF=7,0 +UDCONF: 7,0,13 OK

24.20.3 Defined values

Parameter	Type	Description
<socket_id>	Number	Socket identifier; used when changing the Direct Link settings. The allowed range is 0-6
<character_trigger>	Number	Enhanced Direct Link character trigger, the value represents the ASCII code (in base 10) of the character to be used as character trigger. Valid range is -1, 0-255, the factory-programmed value is -1, -1 means trigger disabled

24.21 Congestion timer configuration for Direct Link +UDCONF=8

+UDCONF=8						
Modules	SARA-G340 SARA-G350 LISA-U200-02S LISA-U200-52S LISA-U200-62S LISA-U260-02S LISA-U270-02S SARA-U					
Attributes	Syntax	PIN required	Settings saved	Can be aborted	Response time	Error reference
	full	No	No	No	-	+CME Error

24.21.1 Description

Sets the congestion timer of the interested socket identifier for the data transmission enhanced Direct Link.

24.21.2 Syntax

Type	Syntax	Response	Example
Set	AT+UDCONF=8,<socket_id>,<congestion_timer>	OK	AT+UDCONF=8,0,120000 OK
Read	AT+UDCONF=8,<socket_id>	+UDCONF: 8,<socket_id>,<congestion_timer> OK	AT+UDCONF=8,0 +UDCONF: 8,0,120000 OK

24.21.3 Defined values

Parameter	Type	Description
<socket_id>	Number	Socket identifier; used when changing the Direct Link settings. Valid range is 0-6
<congestion_timer>	Number	Enhanced Direct Link congestion timer (in milliseconds); valid range is 0, 1000-720000; the factory-programmed value is 60000, 0 means trigger disabled

24.22 Socket Control +USOCTL

+USOCTL						
Modules	LEON-G SARA-G340 SARA-G350 LISA-U SARA-U					
Attributes	Syntax	PIN required	Settings saved	Can be aborted	Response time	Error reference
	partial	No	No	No	-	+CME Error

24.22.1 Description

Allows interaction with the low level socket layer.

24.22.2 Syntax

Type	Syntax	Response	Example
Set	AT+USOCTL=<socket>,<param_id>	+USOCTL: <socket>,<param_id>,<param_val>[,<param_val2>] OK	AT+USOCTL=0,2 +USOCTL: 0,2,38 OK

24.22.3 Defined values

Parameter	Type	Description
<socket>	Number	Socket identifier. The range goes from 0 to 6
<param_id>	Number	Control request identifier. Possible values are: <ul style="list-style-type: none"> • 0: query for socket type • 1: query for last socket error • 2: get the total amount of bytes sent from the socket • 3: get the total amount of bytes received by the socket • 4: query for remote peer IP address and port • 10: query for TCP socket status (only TCP sockets) • 11: query for TCP outgoing unacknowledged data (only TCP sockets) • 5-9, 12-99: RFU
<param_val>	Number / String	This value may assume different means depending of <param_id>. <ul style="list-style-type: none"> If <param_id> is 0, <param_val> can assume these values: <ul style="list-style-type: none"> • 6 TCP socket • 17: UDP socket If <param_id> is 1, <param_val> can assume these values: <ul style="list-style-type: none"> • N: last socket error If <param_id> is 2, <param_val> can assume these values: <ul style="list-style-type: none"> • N: the total amount (in bytes) of sent (acknowledged + unacknowledged) data If <param_id> is 3, <param_val> can assume these values: <ul style="list-style-type: none"> • N: the total amount (in bytes) of received (read) data If <param_id> is 4, <param_val> can assume these values: <ul style="list-style-type: none"> • A string representing the remote peer IP address expressed in dotted decimal form If <param_id> is 10, <param_val> can assume these values: <ul style="list-style-type: none"> • 0: the socket is in INACTIVE status • 1: the socket is in LISTEN status • 2: the socket is in SYN_SENT status • 3: the socket is in SYN_RCVD status • 4: the socket is in ESTABLISHED status • 5: the socket is in FIN_WAIT_1 status • 6: the socket is in FIN_WAIT_2 status • 7: the socket is in CLOSE_WAIT status • 8: the socket is in CLOSING status • 9: the socket is in LAST_ACK status • 10: the socket is in TIME_WAIT status If <param_id> is 11, <param_val> can assume these values:



Parameter	Type	Description
		<ul style="list-style-type: none"> N: the total amount of outgoing unacknowledged data
<param_val2>	Number	This value is present only when <param_id> is 4. It represents the remote peer IP port.

24.22.4 Notes

LEON-G

- The range of <socket> parameter goes from 0 to 15.

24.23 IP Change Notification +UIPCHGN

+UIPCHGN						
Modules	SARA-G340 SARA-G350					
	LISA-U200-02S LISA-U200-52S LISA-U200-62S LISA-U200-82S LISA-U260-02S LISA-U270-01S LISA-U270-62S SARA-U					
Attributes	Syntax	PIN required	Settings saved	Can be aborted	Response time	Error reference
	full	No	<i>NVM</i>	No	-	<i>UIIPGHGN Error</i> <i>+CME Error</i>

24.23.1 Description

Enable, disables or forces the IP change notification (CN) functionality. This command only works for internal PDP context activation (refer to *+UCSD*, *+UCSDA* and *+UCSND* AT commands for establishing a CSD connection and to *+UPSD*, *+UPSDA* and *+UPSND* AT commands for establishing a PSD connection).

The IP CN notifies a remote server about changes in the module IP address.

The following information is delivered to the destination server:

- Current IP address of the module
- IMEI of the module (optional)
- IMSI of the inserted SIM card (optional)
- Username (optional)
- MD5 hash of user password (hex format) (optional)
- Custom information (up to 128 bytes)

The notification is sent via a HTTP GET request.

The GET request format is the following:

```
GET /<path>?
myip=<ip>&imei=<imei>&imsi=<imsi>&user=<username>&pass=<md5paswd>&cust=<cust_
info> HTTP/1.0{CRLF}
```

```
Host: <domain_name>{CRLF}
```

```
User-Agent: u-blox IP Change Notification Agent 1.0{CRLF}
```

```
{CRLF}
```

<ip>, <imei> (if enabled) and <imsi> (if enabled) fields inside the HTTP request are automatically inserted by the module, <domain_name>, <path>, <username>, <password> and <cust_info> fields must be provided by the application through the +UIPCHGN AT command.

{CRLF} is a placeholder for hexadecimal character 0x0D (CR) and 0x0A (LF).

The HTTP response from the server is parsed to recognize the HTTP response code and the text between the <ipchgn_r> and the </ipchgn_r> tags inside the response body. This text is not mandatory and can be freely customized by the customer (up to 64 printable characters).



A real world example follows:

Request (from the module)

```
GET /modemipnotify.php?myip=123.56.214.2&imei=992237050009739&imsi=992105301545971&user=test_user&pass=16ec1ebb01fe02ded9b7d5447d3dfc65&cust=Product%3A+Tracker+v.1.0 HTTP/1.0{CRLF}
```

```
Host: somedomain.com {CRLF}
```

```
User-Agent: u-blox IP Change Notification Agent 1.0{CRLF}
```

```
{CRLF}
```

Where

Field	Content	Comment
server	somedomain.com	Specified via +UIPCHGN AT command
path	modemipnotify.php	Specified via +UIPCHGN AT command
myip	123.56.214.2	
imei	992237050009739	
imsi	992105301545971	
user	test_user	Specified via +UIPCHGN AT command
pass	16ec1ebb01fe02ded9b7d5447d3dfc65	MD5 hash of "test_password"Specified via +UIPCHGN AT command
cust_info	Product%3A+Tracker+v.1.0	URL encoding of the string "Product: Tracker v.1.0". Specified via +UIPCHGN AT command

Response (from the server)

```
HTTP/1.0 200 OK {CRLF}
```

```
Content-Type: text/html {CRLF}
```

```
Content-Length: 31 {CRLF}
```

```
Connection: close {CRLF}
```

```
{CRLF}
```

```
<ipchgn_r>IP_UPDATED</ipchgn_r>
```

Another real world example (without custom information, username and password):

```
GET /modemipnotify.php?myip=123.56.214.2&imei=992237050009739&imsi=992105301545971&user=&pass=&cust= HTTP/1.0{CRLF}
```

```
Host: somedomain.com {CRLF}
```

```
User-Agent: u-blox IP Change Notification Agent 1.0{CRLF}
```

```
{CRLF}
```



Where:

Field	Content	Comment
server	somedomain.com	
path	modemipnotify.php	
myip	123.56.214.2	
imei	992237050009739	
imsi	992105301545971	
user		(empty)
pass		(empty)
cust_info		(empty)

Response (from the server)

```
HTTP/1.0 200 OK {CRLF}
```

```
Content-Type: text/html {CRLF}
```

```
Content-Length: 31 {CRLF}
```

```
Connection: close {CRLF}
```

```
{CRLF}
```

```
<ipchgn_r>IP_UPDATED</ipchgn_r>
```



Password hashing and URL encoding are performed by the module, so parameters < password> and <cust_info> must be inserted in plain text in the +UIPCHGN command (See command parameters below).

The command configuration is stored in the NVM; if enabled, the command automatically works after a reboot and the +UIPCHGN: 0 URC is sent to all terminals in this case.

If the IP CN feature is enabled, the notification is performed at each PDP context activation. If the client is enabled when a PDP connection is already active, it starts to update IP address on the next PDP context activation.



The custom information field (< cust_info >) is URL encoded into the HTTP request, this means that the final custom information inside the HTTP GET request may be longer than 128 bytes.



The IP CN feature only works for PDP connections configured and enabled by +UPSD and +UPSDA command.



The username and password are not compulsory, but it is encouraged to use them for security reasons.

24.23.2 Syntax

Type	Syntax	Response	Example
Set	AT+UIPCHGN=<action>[,<server>,<port>,<path>,<send_imei>,<send_imsi>,<username>,<password>,<cust_info>]	OK	To enable the IP CN feature: AT+UIPCHGN=1,"somedomain.com",80,"modemipnotify.php",1,1,"test_user","test_password","Product: Tracker v.1.0" OK To force another IP CN to the remote server (CN must be previously enabled):



Type	Syntax	Response	Example
			AT+UIPCHGN=2 OK To disable the IP CN feature: AT+UIPCHGN=0 OK
Read	AT+UIPCHGN?	+UIPCHGN: <status>[,<server>,<port>,<path>,<send_imei>,<send_imsi>,<username>,<password>,<cust_info>] OK	+UIPCHGN: 1,"somedomain.com",80,"/modemipnotify.php",1,1,"test_user","test_password","Product: Tracker v.1.0" OK
Test	AT+UIPCHGN=?	+UIPCHGN: (list of supported <action>s),<server>,(list of supported <port>s),<path>,(list of supported <send_imei>s),(list of supported <send_imsi>s),<username>,<password>,<cust_info> OK	+UIPCHGN: (0 2),"server",(1 65535),"path",(0 1),(0 1),"username","password","cust_info" OK
URC		+UIPCHGN: <code>[,<reply_str>]	+UIPCHGN: 200,"IP_UPDATED"

24.23.3 Defined values

Parameter	Type	Description
<action>	Number	Disable / Enable / Force the Update of IP CN feature <ul style="list-style-type: none"> 0 (factory-programmed value): disable the feature 1: enable the feature 2: force IP notification update Note: < action > = 2 could be used when the +UIPCHGN URC returns a code different from 200.
<server>	String	Indicates the remote host to which the HTTP GET request must be sent to notify the IP change event. It can be either a domain name (e.g. "somedomain.com") or an IP address in numeric format (e.g. "173.194.35.145"), always between double quotes. Maximum length: 64 characters Mandatory parameter with < action>=1, ignored with < action>=0 or < action>=2
<port>	Number	Indicates the server port to which the HTTP GET request must be sent. Valid range: from 1 to 65535 Mandatory parameter with < action> =1, ignored with < action> =0 or < action> =2
<path>	String	Indicates the server path to be used inside the HTTP GET request. The insertion of the starting "/" is not mandatory (the software automatically adds it if omitted). The string must be enclosed between double quotes. Maximum length: 64 characters Mandatory parameter with < action> =1, ignored with < action> =0 or < action> =2
<username>	String	Indicates the username to be sent inside the HTTP request. The string must be enclosed between double quotes. Max length: 64 characters Mandatory parameter with < action> =1, ignored with < action> =0 or < action> =2 If no username is required, this parameter must be inserted as empty string ("")
<send_imei>	Number	Indicates if the notification must send the modem IMEI inside the notification HTTP GET request <ul style="list-style-type: none"> 0: do not send IMEI 1: send IMEI Mandatory parameter with < action> =1, ignored with < action> =0 or < action> =2
<send_imsi>	Number	Indicates if the notification must send the modem IMSI inside the notification HTTP GET request Valid range: 0-1 <ul style="list-style-type: none"> 0: do not send IMSI 1: send IMSI



Parameter	Type	Description
<password>	String	Mandatory parameter with <action> =1, ignored with <action> =0 or <action> =2 Indicates the password whose MD5 hash is to be sent inside the HTTP request. The string must be enclosed between double quotes. Maximum length: 32 characters Mandatory parameter with <action>=1, ignored with <action>=0 or <action>=2 If no password is required, this parameter must be inserted as empty string ("")
<cust_info>	String	Indicates the custom information to send inside the HTTP GET request. The string must be enclosed between double quotes. Maximum length: 128 characters Mandatory parameter with <action>=1, ignored with <action>=0 or <action>=2 If no custom information is required, this parameter must be inserted as empty string ("")
<status>	Number	This value indicates the status of the IP CN feature <ul style="list-style-type: none"> • 0: disabled • 1: enabled
<code>	Number	This is the code returned by the +UUIPCHGN URC. Values lower than 100 should be interpreted as internal error according to the IP CN error table. <code> values greater than 100 must be interpreted as HTTP server response code. If error is not present the code returned by the +UUIPCHGN should be 200. The +UUIPCHGN: 0 URC is sent to all terminals at boot if the IP CN feature is enabled from a previous working session.
<reply_str>	String	This is the text inserted between the <ipchgn_r> and </ipchgn_r> tags into the response body from the server. The string is enclosed between double quotes. The maximum length of this string is 64 bytes; if the server sends a longer string, it will be truncated. The parameter is only provided when the information is present in the HTTP response from the remote server and not if an internal error occurred.

24.24 Socket Always On +USOAO

+USOAO						
Modules	SARA-G340 SARA-G350					
	LISA-U200-02S LISA-U200-52S LISA-U200-62S LISA-U200-82S LISA-U260-02S LISA-U270-02S LISA-U270-62S SARA-U					
Attributes	Syntax	PIN required	Settings saved	Can be aborted	Response time	Error reference
	full	No	NVM	No	- (except URC)	+CME Error

24.24.1 Description

The +USOAO command allows the configuration of the Socket Always On feature.

The Socket Always On (SAO) causes the module to try establishing an automatic Direct Link (DL) IP connection (or to start listening on an IP port, and in case establish a DL connection) over UART interface as soon as the module is powered on, so that "dumb" terminals (equipments without the logic to send AT commands and parse the responses) can directly use an IP connection.

The Direct Link connection used by SAO cannot be established over the USB or SPI physical interfaces but over the UART physical interface only.

SAO may work in "client" and "server" modes:

- Client mode: the module establishes a Direct Link IP connection with a defined remote server
- Server mode: the module waits for an incoming connection request on a defined IP port; when an acceptable remote client is recognized, the Direct Link is established

For client mode, the user must specify these parameters:

- Internal PDP profile to be used for GPRS connection
- Destination host IP number or hostname
- Destination host port

For server mode, the user must specify these parameters:

- Internal PDP profile to be used for GPRS connection



- Listening port
- White list of remote hosts (optional)

If the feature is enabled, it starts working at the next module power on.

When using SAO in server mode and the network dynamically assigns an IP address (which is most often the case), then it is advisable to enable also the IP Change Notification feature to inform a remote server about the assigned IP address. Refer to [+UIPCHGN](#) command description.

When using SAO in server mode, the network dynamically assigns an IP address and the remote client uses an IP hostname rather than a numerical IP address to connect to the module, then it is advisable to enable the dynamic DNS feature. Refer to [+UDYNDNS](#) command description.







A usage example for client mode configuration follows:

AT command	Comment
PSD connection settings	
AT+UPSD=0,1,"your.apn"	Configures the APN for internal PDP profile 0; "your.apn" is an example
AT+UPSDA=0,1	Stores the parameters of PDP profile 0 to NVM
Socket Always On configuration	
AT+USOAO=1,0	Sets PDP profile 0 as default connection to be activated after module start-up
AT+USOAO=2,0	Sets client mode
AT+USOAO=3,"somehost.somedomain.com"	Sets the remote host for the TCP connection. The value can also be an IP address.
AT+USOAO=4,8084	Sets the remote port for the TCP connection
AT+USOAO=0,1	Enables the Socket Always On functionality.
AT+CPWROFF	Shuts down the module. On the next boot the functionality is active.
After modem start-up (wait around 15 s)	
+UUSOAO: "122.26.56.55",8084	This is a notification of the connection establishment to the remote host. The IP address shown is the IP address got after the DNS resolution of the hostname. The IP shown here is for example purpose only. The module is connected in direct link mode (the data sent to the UART port is forwarded to the network and vice-versa). If the connection drops, it is automatically re established

A usage example for server mode configuration follows:

AT Command	Comment
PSD connection settings	
AT+UPSD=0,1,"your.apn"	Configures the APN for internal PDP profile 0; "your.apn" is an example
AT+UPSDA=0,1	Stores the parameters of PDP profile 0 to NVM
Socket Always On configuration	
AT+USOAO=1,0	Sets PDP profile 0 as default connection to be activated after module start up
AT+USOAO=2,1	Sets server mode
AT+USOAO=4,2000	Sets the listening port
AT+USOAO=20,"143.22.33.0"	Sets the first host in white list (optional, up to 10 host can be added)
AT+USOAO=21,"143.22.33.1"	Sets the second host in white list (optional, up to 10 host can be added)
AT+USOAO=0,1	Enables the Socket Always On functionality. If any of the previous settings is not performed the command returns error.
AT+UIPCHGN=1,"somedomain.com",80,"modemipnotify.php",1,1,"test_user","test_password"	Configures the IP Change notification feature (optional but recommended for server mode). Refer to +UIPCHGN command description for details
AT+CPWROFF	Shuts down the module. On the next boot the functionality is active.

AT Command	Comment
After module start-up (wait around 15 s)	
+UUIPCHGN: 200,"msg"	IP Change Notification result (it is not be prompted if IP change notification is disabled)
+UUSOAOL: "151.22.34.66",2000	Notifies the Socket Always On is enabled in server mode and listening on IP 151.22.34.66 and port 2000
A new connection is accepted...	
+UUSOAOC: "143.22.33.1",5996	Notifies a new connection has been accepted from IP 143.22.33.01 and port 5996. Now it is possible to exchange data with the remote host. The data sent to the UART port is forwarded to the network and vice-versa. If the remote host disconnects, the modem keeps in DL mode waiting for new incoming connections (which are not notified)

-  The module never exits from direct link mode; if the remote client disconnects or the network is no longer available, the connection will be re-established automatically and transparently.
-  In order for SAO to work, the following conditions must be true:
 - the SIM PIN must be disabled, or the right PIN must be provided via the +USOAO=10 sub-command
 - the UART must be correctly configured for speed (refer to +IPR) and flow control (refer to +IFC)
 - the PSD connection parameters must be configured with the +UPSD command and stored in NVM
 - the automatic or manual network registration must be enabled (see +COPS command description).
 If any of the SAO settings are wrong (e.g. setting the server mode when using UDP protocol), the SAO can be enabled but will not start.
-  When connected in server mode, if a new connection from an acceptable client address is received, the current connection is silently dropped and the new one is accepted.
-  The Direct Link connection used by SAO is affected by the triggers (as specified in [Chapter 24.15.5](#)). If they are not explicitly modified, the default triggers will apply.
-  When the module boots with SAO enabled, the PSD and TCP/IP commands cannot be reliably used (their functionalities are being used by the SAO). The only safe option is to disable SAO and reboot (with AT+USOAO=0,0 and AT+CPWROFF).
-  When the module boots with SAO enabled, the MUX protocol (see +CMUX command description) must not be enabled on UART interface.

24.24.2 Syntax

Type	Syntax	Response	Example
Set	Generic syntax: AT+USOAO=<usoao_param_id>,<param_val>	OK	AT+USOAO=0,1 OK
	Enable/disable Socket Always On: AT+USOAO=0,<enable>	OK	AT+USOAO=0,1 OK
	Set the PSD connection: AT+USOAO=1,<profile_id>	OK	AT+USOAO=1,5 OK
	Set client or server mode: AT+USOAO=2,<server_mode>	OK	AT+USOAO=2,0 OK
	Set the remote host (for client mode): AT+USOAO=3,<remote_host>	OK	AT+USOAO=3,"www.remotehost.it" OK
	Set the IP port number: AT+USOAO=4,<ip_port>	OK	AT+USOAO=4,8088 OK
	Set the IP protocol: AT+USOAO=5,<protocol>	OK	AT+USOAO=5,17 OK
	Set the SIM PIN:	OK	AT+USOAO=10,"123456"

Type	Syntax	Response	Example
	AT+USOAO=10,<pin>		OK
	Set the i-th element of the white list of IP addresses (i=0..9)	OK	AT+USOAO=22,"123.156.0.2"
	AT+USOAO=20+i,<client_address>		OK
Get	Generic syntax: AT+USOAO=<usoao_param_id>	+USOAO: <usoao_param_id>,<param_val> OK	+USOAO: 0,1 OK
	Enable/disable Socket Always On: AT+USOAO=0	+USOAO: 0,<enable> OK	+USOAO: 0,0 OK
	Get the PSD connection: AT+USOAO=1	+USOAO: 1,<profile_id> OK	+USOAO: 1,6 OK
	Get client or server mode: AT+USOAO=2	+USOAO: 2,<server_mode> OK	+USOAO: 2,0 OK
	Get the remote host (for client mode): AT+USOAO=3	+USOAO: 3,<remote_host> OK	+USOAO: 3,"www.remotehost.it" OK
	Get the IP port number: AT+USOAO=4	+USOAO: 4,<ip_port> OK	+USOAO: 4,8088 OK
	Get the IP protocol: AT+USOAO=5	+USOAO: 4,<protocol> OK	+USOAO: 5,17 OK
	Get the SIM PIN: AT+USOAO=10	+USOAO: 10,* OK	+USOAO: 10,* OK
	Get the i-th element of the white list of IP addresses (i=0..9) AT+USOAO=20+i	+USOAO: 20+i,<client_address> OK	AT+USOAO=22,"123.156.0.2" OK
Test	AT+USOAO=?	+USOAO: (list of supported <usoao_param_id>'s) OK	+USOAO: (0-5,10,20-29) OK
URC	(listening URC)	+UUSOAO: <local_ip>,<local_port>	+UUSOAO: "151.22.34.66",2000
URC	(connection URC)	+UUSOAO: <remote_ip>,<remote_port>	+UUSOAO: "122.26.56.55",8084

24.24.3 Defined values

Parameter	Type	Description
<usoao_param_id>	Number	Identifier of the meaning of the next parameter(s). Valid values/ranges: 0-5, 10 and 20-29. Meanings: <ul style="list-style-type: none"> 0: enable/disable the socket always on feature 1: configure the default PSD connection 2: client/server mode 3: remote host (for client mode only) 4: remote host port for client mode or local listening port for server mode 5: socket type: UDP (for client mode only) or TCP 10: SIM PIN 20-29: white list items (for server mode only)
<enable>	Number	Enables or disables the Socket Always On at the next power on: <ul style="list-style-type: none"> 0: (factory-programmed setting): feature disabled 1: feature enabled
<profile_id>	Number	This is the same <profile_id> used in +UPSD command. Range between 0 and 6. Factory-programmed setting is 0.
<server_mode>	Number	Defines the client or server module behavior. Range between 0 and 1. <ul style="list-style-type: none"> 0: (factory-programmed setting): client mode 1: server mode



Parameter	Type	Description
<remote_host>	String	The remote server IP address or hostname to connect to while in client mode. This value is ignored for server configuration. The factory-programmed setting is an empty string ("").
<ip_port>	Number	In client mode it represents the remote port to connect to; in server mode it represents the local port on which the module must wait incoming connection. The range 1-65535. The factory-programmed setting is 2000.
<protocol>	Number	Protocol type to be used for socket creation. <ul style="list-style-type: none">• 6: TCP• 17: UDP (not valid for server mode) The factory-programmed setting is 6 (TCP).
<pin>	String	SIM PIN: 4-to-8 characters long string of decimal digits It is used if the SIM requires it and only if there are 3 attempts left. If empty, no PIN is attempted. The factory-programmed setting is an empty string (no PIN). The PIN cannot be revealed - the get command AT+USOA=10 only returns a string of asterisks "*****".
<client_address>	String	An entry in the "white list" of remote clients IP addresses, in quoted numerical format (e.g. "123.45.67.89"). If the list is non-empty (i.e. it does not contain only null addresses), only connection requests from the listed addresses is accepted. An empty IP address ("0.0.0.0") is a null address. The factory-programmed setting is an empty IP address.
<local_ip>	String	Local IP address. Only used in +UUSOAOL URC (when the module is in server mode).
<local_port>	Number	Local IP port. Range between 1 and 65535. Used only in +UUSOAOL URC (when the module is in server mode).
<remote_ip>	String	IP address of the remote host connected to the module. Used in +UUSOAOC URCs.
<remote_port>	Number	IP port of the remote host connected to the module. Range between 1 and 65535. Used in +UUSOAOC URCs

24.24.4 Notes

- +UUSOAOL and +UUSOAOC URCs are displayed only if the socket always on connection is active.
- +UUSOAOL URCs are only displayed if socket always on is set in server mode.
- Only UART displays +UUSOAOL and +UUSOAOC.

25. FTP

Proprietary u-blox AT commands. FTP AT commands set can be used for sending and receiving files over the available bearer, transparently retrieving and storing them in the file system. Standard file and directory management operations on the remote FTP server are as well possible. PSD or CSD connection must be activated before using FTP client services refer to **+UCSD**, **+UCSDA** and **+UCSND** AT commands for establishing a CSD connection and to **+UPSD**, **+UPSDA** and **+UPSND** AT commands for establishing a PSD connection.

Basically, two AT commands are necessary for an FTP client service: one AT command to configure the FTP profile, a second AT command to execute a specific FTP command. The final result of an FTP execute command will be notified through the URC +UUFTPCR whereas data will be provided through URC +UUFTPCD.

When these commands report an error which is not a +CME ERROR, the error code can be queried using the **+UFTPER** AT command.

25.1 FTP service configuration +UFTP

+UFTP						
Modules	LEON-G SARA-G340 SARA-G350					
	LISA-U SARA-U					
Attributes	Syntax	PIN required	Settings saved	Can be aborted	Response time	Error reference
	partial	No	No	No	< 10s	Appendix A.1.1

25.1.1 Description

Sets up a parameter for FTP service, or resets a parameter to its factory-programmed value. The set/reset command needs to be executed for each single <param_tag>. The read command returns the current setting of all the FTP parameters, one per line (i.e. the FTP profile). The FTP parameter values set with this command are all volatile (not stored in non-volatile memory)

25.1.2 Syntax

Type	Syntax	Response	Example
Set	AT+UFTP=<param_tag>,<param_val>	OK	AT+UFTP=7,21 OK
Reset	AT+UFTP=<param_tag>	OK	AT+UFTP=7 OK
Read	AT+UFTP?	+UFTP: 0,<param_val0> +UFTP: 1,<param_val1> ... OK	+UFTP: 0,"216.239.59.147" +UFTP: 1,"" +UFTP: 2,"username" +UFTP: 4,"account" +UFTP: 5,0 +UFTP: 6,0 +UFTP: 7,21 +UFTP: 8,0 OK
Test	AT+UFTP=?	+UFTP: (list of supported <param_tag>s) OK	+UFTP: (0-8) OK

25.1.3 Defined values

Parameter	Type	Description
<param_tag>	Number	<ul style="list-style-type: none"> 0: FTP server IP address; <param_val> is the text string of FTP server IP address in dotted decimal notation form (e.g. 111.222.111.111)



Parameter	Type	Description
		<ul style="list-style-type: none"> • 1: FTP server name <param_val> is the text sting of FTP server name (e.g. "ftp.server.com") Maximal length 128 characters • 2: Username <param_val> is the user name text string (maximum 30 characters) for the FTP login procedure • 3: Password <param_val> is the password text string (maximum 30 characters) for the FTP login procedure • 4: Account <param_val> is the additional user account text string (maximum 30 characters) if required for the FTP login procedure • 5: Inactivity timeout; <param_val> is the inactivity timeout period in seconds, from 0 to 8640 0 s. 0 means no timeout (the FTP session will not be terminated in the absence of incoming traffic). The default value is 30 s • 6: FTP mode <param_val> selects the FTP mode: <ul style="list-style-type: none"> o 0 (default value): Active o 1: Passive • 7: FTP server port <param_val> is the remote FTP server listening port, it must be a valid TCP port value: <ul style="list-style-type: none"> o Numeric value between 1 and 65535: default value is 21 • 8: FTP Secure option in explicit mode (SSL encryption of FTP control channel; FTP data channel is not encrypted) <param_val> selects the Secure option (explicit mode) of FTP client service: <ul style="list-style-type: none"> o 0 (default value): No SSL encryption o 1: Enable SSL encryption of FTP control connection
<param_val>	Number / String	Type and supported content depend on related <param_tag> (details are given above). If <param_val> is not specified the value of the corresponding parameter <param_tag> is reset to default value

25.1.4 Notes

- The response to the read command does not display the <param_tag>=3 (password).
- <param_tag>=0 and <param_tag>=1 are mutually exclusive. If value for <param_tag>=0 is specified by user, then value for <param_tag>=1 is reset or vice versa.
- Some network operators do not allow incoming connections. Due to these limitations introduced by network operators it is possible to encounter problems using FTP active mode. If the FTP active mode fails to exchange files, try the passive mode to solve the problem.
- Some network operators do not allow FTPS. In this case the +UFTPC=1 command (FTP login) will return a failure response via +UUFTPCR URC after an SSL timeout of 30 s.

LISA-U / SARA-U

- During connection to FTP remote server (via FTP login command) the FTP profile parameters cannot be changed or reset to factory-programmed values until disconnection takes place (FTP logout). Only <param_tag>=5 (inactivity timeout), and <param_tag>=6 (FTP mode), can be updated while FTP connection is on the go.

LEON-G / SARA-G340-00S / SARA-G350-00S

- <param_tag>=8 is not supported.

SARA-G340-01S / SARA-G350-01S

- The server IP or name shall be inserted prior to the SSL encryption option (<param_tag>=8).

25.2 FTP command +UFTPC

+UFTPC						
Modules	LEON-G SARA-G340 SARA-G350					
	LISA-U SARA-U					
Attributes	Syntax	PIN required	Settings saved	Can be aborted	Response time	Error reference
	partial	No	No	No	< 10s	Appendix A.1.1

25.2.1 Description

Triggers the FTP actions corresponding to <ftp_command> parameter. The response indicates if sending the command request to FTP process was successful or not. The URC [+UUFTPCR](#) returns the final result of the FTP action to the user. As well, the URC [+UUFTPCD](#) provides the data requested by the user (e.g. file or directory lists) and received from the FTP server.



LISA-U / SARA-U

If the SSL option is enabled and the network operator does not allow FTPS, the +UUFTPCR URC notifies the command failure after an SSL timeout of 30 s.

25.2.2 Syntax

Type	Syntax	Response	Example
Set	AT+UFTPC=<ftp_command>[,<param1>[,<param2>[,<param3>]]]	OK	AT+UFTPC=4,"data.zip","data.zip" OK
Test	AT+UFTPC=?	+UFTPC: (list of supported <ftp_command>s) OK	+UFTPC: (0-5,8,10,11,13,14) OK

25.2.3 Defined values

Parameter	Type	Description
<ftp_command>	Number	<p>This AT command just sends a command request to the FTP process. The +UUFTPCR URC notifies the final FTP result.</p> <ul style="list-style-type: none"> • 0: FTP logout; terminates the FTP session by performing a logout. <ul style="list-style-type: none"> ◦ <param1>, <param2>, <param3> are not allowed (do not give any value) • 1: FTP login; connects to the FTP server using the parameters of the current FTP profile (set via AT+UFTP command). <ul style="list-style-type: none"> ◦ <param1>, <param2>, <param3> are not allowed (do not give any value) • 2: Delete the file from the FTP server: <ul style="list-style-type: none"> ◦ <param1> mandatory parameter; text string of the file name to be deleted from FTP host ◦ <param2>, <param3> parameters are not allowed (do not give any value) • 3: Rename the file. This AT command just sends requests to the FTP process. The +UUFTPCR URC notifies the final FTP result. <ul style="list-style-type: none"> ◦ <param1> mandatory parameter; text string of the old file name on the FTP host, to be renamed. For the limit of the length of the string, see Chapter 1.1.3. ◦ <param2> mandatory parameter; text string of the new file name. For the limit of the length of the string, see Chapter 1.1.3. ◦ <param3> parameter is not allowed (do not give any value) • 4: Retrieve the file from the FTP server. <ul style="list-style-type: none"> ◦ <param1> mandatory parameter; it is the remote file name text string to be retrieved from the FTP host. ◦ <param2> mandatory parameter; it is the local file name (module file system) text string to be stored on the file system. For the limit of the length of the string, refer to Chapter 1.1.3. ◦ <param3> optional parameter: set to 1 to restart the data retrieving from the last data received during the previous download interrupted due to error. If it is set to 0 (default value), the file is retrieved from beginning. • 5: Store the file on the FTP server.



Parameter	Type	Description
		<ul style="list-style-type: none"> o <param1> mandatory parameter; it is the local file name (module file system) text string to be sent from the file system. For the limit of the length of the string, refer to Chapter 1.1.3. o <param2> mandatory parameter; it is the remote file name to be stored on the FTP server. For the limit of the length of the string, refer to Chapter 1.1.3. o <param3> optional parameter; it represents the number of bytes already sent to the FTP server. The server writes the file from the offset indicated with this parameter.
		<ul style="list-style-type: none"> • 6: Retrieve a file from the FTP server using direct link mode. This command handles the initial steps of the FTP protocol for retrieving a file; after that it will establish a transparent end to end communication with the data connection TCP socket via the serial interface. After the CONNECT message, the file content will be directly sent to the serial interface. The user must switch off the direct link mode (sending +++ to the serial interface) when the data stream is finished. This operation may take up to 10 s because the command also handles the final steps of the FTP protocol. <ul style="list-style-type: none"> o <param1> mandatory parameter; it is the remote file name to be retrieved from the FTP server; o <param2> optional parameter: it represents the number of bytes already received from the FTP server. The server sends the data from the value indicated with this parameter. o <param3> parameter is not allowed (do not give any value)
		<ul style="list-style-type: none"> • 7: Send a file to the FTP server using the direct link mode. This command handles the initial steps of the FTP protocol for sending a file; after that it will establish a transparent end to end communication with the data connection TCP socket via the serial interface. After the CONNECT message, the user can send the file content via the serial interface. Once finished, the user must wait at least 2 s before sending the +++ sequence to switch off the direct link mode. This operation may take a few seconds because the command also handles the final steps of the FTP protocol. <ul style="list-style-type: none"> o <param1> mandatory parameter; it is the remote file name to be stored in the FTP server; o <param2> optional parameter: it represents the number of bytes sent to the FTP server. The server writes the file from the offset indicated with this parameter. o <param3> parameter is not allowed (do not give any value)
		<ul style="list-style-type: none"> • 8: Change the working directory to the specified one: <ul style="list-style-type: none"> o <param1> mandatory parameter; it is the text string of the destination directory name on the FTP host. For the limit of the length of the string, see Chapter 1.1.3. o <param2> and <param3> parameters are not allowed (do not give a value).
		<ul style="list-style-type: none"> • 9: RFU;
		<ul style="list-style-type: none"> • 10: Create a directory on the FTP host. <ul style="list-style-type: none"> o <param1> mandatory parameter; text string of the new directory name to be made on the FTP server. For the limit of the length of the string, see Chapter 1.1.3. o <param2> and <param3> parameters are not allowed (do not give a value).
		<ul style="list-style-type: none"> • 11: Remove the directory from the remote FTP server. <ul style="list-style-type: none"> o <param1> mandatory parameter; it is the string of the existing directory name to be removed. For the limit of the length of the string, see Chapter 1.1.3. o <param2> and <param3> parameters are not allowed (do not give a value).
		<ul style="list-style-type: none"> • 12: RFU;
		<ul style="list-style-type: none"> • 13: Information of a file or a directory. The URC <code>+UUFTPCD</code> returns the information of the specified file or directory from the FTP server. <ul style="list-style-type: none"> o <param1> optional parameter; the text string of the path file/directory name to be listed. If not specified, the current directory list is requested. For the limit of the length of the string, see Chapter 1.1.3. o <param2> and <param3> parameters are not allowed (do not give a value).
		<ul style="list-style-type: none"> • 14: List the file names in a specified directory. The URC <code>+UUFTPCD</code> returns the list of the file names received from FTP server. <ul style="list-style-type: none"> o <param1> optional parameter; the text string of the path (file or directory) to be name listed. If not specified, the list of the files names of current working directory is requested. For the limit of the length of the string, see Chapter 1.1.3. o <param2> and <param3> parameters are not allowed (do not give a value).
<param1>	String	Content depend on related <ftp_command> (details are given above)
<param2>	String	Content depend on related <ftp_command> (details are given above)
<param3>	String	Content depend on related <ftp_command> (details are given above)

25.2.4 Notes

LISA-U / SARA-U

- If `<ftp_command>=6` and the data stream is completed, the data connection is closed and it is not needed to send `+++` to switch off direct link.

LISA-U1 / LISA-U2x0-01S / LISA-U200-00S

- `<param2>` is not supported when `<ftp_command>=6` or `<ftp_command>=7`.

LEON-G / SARA-G

- `<param2>` is not supported when `<ftp_command>=6` or `<ftp_command>=7`.

25.3 FTP Unsolicited Data URC +UUFTPCD

+UUFTPCD	
Modules	LEON-G SARA-G340 SARA-G350 LISA-U SARA-U

25.3.1 Description

Returns the data received from the remote FTP server in response to a specified `<ftp_command>` request previously sent via `+UFTPC` command.



LISA-U / SARA-U

The URC +UUFTPCD is displayed only on the AT terminal that issued the +UFTPC related command.

25.3.2 Syntax

Type	Syntax	Response	Example
URC		+UUFTPCD: <code><ftp_command></code> , <code><ftp_data_</code> +UUFTPCD: 13,16,"16 bytes of data" <code>len></code> , <code><ftp_data></code>	

25.3.3 Defined values

Parameter	Type	Description
<code><ftp_command></code>	Number	FTP command as detailed in <code>+UFTPC</code> command description.
<code><ftp_data_len></code>	Number	Amount of data in bytes
<code><ftp_data></code>	String	Data available from the FTP server in the ASCII [0x00,0xFF] range. The starting quotation mark shall not be taken into account like data, the first byte of data starts after the first quotation mark. The total number of bytes is <code><ftp_data_len></code> . At the end of the byte stream, another quotation mark is provided for user convenience and visualization purposes.

25.4 FTP Command Result URC +UUFTPCR

+UUFTPCR	
Modules	LEON-G SARA-G340 SARA-G350 LISA-U SARA-U

25.4.1 Description

The final result of the operation for an FTP command previously sent with +UFTPC is provided with this URC.

25.4.2 Syntax

Type	Syntax	Response	Example
URC		+UUFTPCR: <code><ftp_command></code> , <code><ftp_</code> +UUFTPCR: 1,1 <code>result></code>	

25.4.3 Defined values

Parameter	Type	Description
<code><ftp_command></code>	Number	FTP command as detailed in Chapter 25.2.3



Parameter	Type	Description
<ftp_result>	Number	<ul style="list-style-type: none"> • 0: Fail • 1: Success

25.5 FTP error +UFTPER

+UFTPER						
Modules	LEON-G SARA-G340 SARA-G350					
	LISA-U SARA-U					
Attributes	Syntax	PIN required	Settings saved	Can be aborted	Response time	Error reference
	full	No	No	No	-	Appendix A.1.1

25.5.1 Description

This command retrieves the error class and code of the last FTP operation.

25.5.2 Syntax

Type	Syntax	Response	Example
Action	AT+UFTPER	+UFTPER: <error_class>,<error_code> OK	+UFTPER: 1,1 OK

25.5.3 Defined values

Parameter	Type	Description
<error_class>	Number	Value of error class. Values are listed in Appendix A.1
<error_code>	Number	Value of class-specific error code (reply code if <error_class> is 0). The values are listed in Appendix A.1.1

26. HTTP

The section describes the u-blox proprietary AT commands that can be used for sending requests to a remote HTTP server, receiving the server response and transparently storing it in the file system. The supported methods are: HEAD, GET, DELETE, PUT, POST file and POST data. A PSD or CSD connection must be activated before using HTTP AT commands.

For establishing a CSD connection refer to [+UCSD](#), [+UCSDA](#) and [+UCSND](#) AT commands.

For establishing a PSD connection refer to [+UPSD](#), [+UPSDA](#) and [+UPSND](#) AT commands.

When these commands report an HTTP error, the error code can be queried using the [+UHTTPER](#) AT command.



If using CellLocate[®] and HTTP commands HTTP profiles in the range 1-3 must be used.

26.1 HTTP control +UHTTP

+UHTTP						
Modules	LEON-G SARA-G340 SARA-G350					
	LISA-U SARA-U					
Attributes	Syntax	PIN required	Settings saved	Can be aborted	Response time	Error reference
	partial	No	No	No	< 10s	Appendix A.1

26.1.1 Description

Configures, reads or resets (to the factory-programmed values) the HTTP application profile parameters. Up to 4 different HTTP profiles can be defined. To set all the parameters in an HTTP profile a set command for each <param_tag> needs to be issued.



The configured HTTP profile parameters are not saved in the non volatile memory.



The read command has two possible usages. The functionality of the command differs with the number of command parameters issued:

- Only the first command parameter (<profile_id>) issued: the module resets all the profile parameters (to the factory-programmed values) for the profile specified with <profile_id>
- Only the first and second command parameters used (<profile_id>, <param_tag>): the module returns the current value of the profile parameter specified with <param_tag> and related to the profile specified with <profile_id>

26.1.2 Syntax

Type	Syntax	Response	Example
Set	AT+UHTTP=<profile_id>,<param_tag>,<param_val>	OK	AT+UHTTP=2,0,"125.24.51.133" OK
Read	AT+UHTTP=<profile_id>,<param_tag>	+UHTTP: <profile_id>,<param_tag>,<param_val> OK	AT+UHTTP=2,0 +UHTTP: 2,0,"125.24.51.133" OK
	AT+UHTTP=<profile_id>	OK	AT+UHTTP=2 OK
Test	AT+UHTTP=?	[+UHTTP: (list of supported <profile_id>s),(list of supported <param_tag>s)] OK	+UHTTP: (0-3),(0-9) OK

26.1.3 Defined values

Parameter	Type	Description
<profile_id>	Number	HTTP profile identifier, in range 0-3



Parameter	Type	Description
<param_tag>	Number	<ul style="list-style-type: none"> • 0: HTTP server IP address <ul style="list-style-type: none"> o <param_val>: HTTP server IP address (string); 15 characters in dotted decimal notation form ([0-255].[0-255].[0-255].[0-255]). The factory-programmed value is an empty text string. • 1: HTTP server name <ul style="list-style-type: none"> o <param_val>: HTTP server name (string); the maximum length is 128 characters (e.g. "http.server.com"). The factory-programmed value is an empty text string. • 2: username <ul style="list-style-type: none"> o <param_val>: user name (string); the maximum length is 30 characters; it is used for the HTTP login procedure if the authentication is used. The factory-programmed value is an empty text string. • 3: password <ul style="list-style-type: none"> o <param_val>: password (string); the maximum length is 30 characters; it is used for the HTTP login procedure if the authentication is used. The factory-programmed value is an empty text string. • 4: authentication type <ul style="list-style-type: none"> o <param_val>: HTTP authentication method (number); the allowed values are: <ul style="list-style-type: none"> - 0 (factory-programmed value): no authentication - 1: basic authentication (the password and username must be set; see <param_tag>=2 and <param_tag>=3) • 5: HTTP server port <ul style="list-style-type: none"> o <param_val> server port (number); range 1-65535. It means the HTTP server port to be used in a HTTP request; the factory-programmed value is 80. • 6: HTTP Secure option (SSL encryption) <ul style="list-style-type: none"> o <param_val> enable/disable HTTPS (SSL encryption) (number). It enables or disables the HTTPS (SSL secured connection for HTTP application) usage: <ul style="list-style-type: none"> - 0 (factory-programmed value): HTTPS (SSL encryption) disabled and the HTTP server port set to 80 - 1: HTTPS (SSL encryption) enabled and the HTTP server port set to 443 • 7: reserved for internal use only • 8: reserved for internal use only • 9: reserved for internal use only
<param_val>	Number / String	Type and supported content depend on the related <param_tag> parameter; see the <param_tag> specification.

26.1.4 Notes

- <param_tag>=0 and <param_tag>=1 are mutually exclusive. If <param_val> value for <param_tag>=0 is specified by the user, then the value for <param_tag>=1 is reset, or vice versa.
- When HTTP Secure option is enabled, the default HTTP port is automatically set to 443. If the port is manually set (with the <param_tag>=5) to a custom port other than 80 prior to enabling the secure option the custom port setting will not be modified.

LEON-G / SARA-G340-00S / SARA-G350-00S / SARA-G350-00X

- <param_tag>=6 is not supported.

26.2 HTTP command +UHTTTPC

+UHTTTPC						
Modules	LEON-G SARA-G340 SARA-G350					
	LISA-U SARA-U					
Attributes	Syntax	PIN required	Settings saved	Can be aborted	Response time	Error reference
	full	No	No	No	< 10s	Appendix A.1

26.2.1 Description

Triggers the HTTP command specified with <http_command> parameter, using the HTTP application profile parameters (previously set up by +UHTTTP AT command), specified with <profile_id>. The response indicates if sending the command request to HTTP process was successful or not. The final result of HTTP command will be returned to the user via the +UUHTTTPCR URC.

26.2.2 Syntax

Type	Syntax	Response	Example
Set	AT+UHTTTPC=<profile_id>,<http_command>,<path>,<filename>[,<param1>[,<param2>[,<param3>]]]	OK	AT+UHTTTPC=0,1,"/path/file.html", "responseFilename" OK
Test	AT+UHTTTPC=?	+UHTTTPC: (list of supported <profile_id>s),(list of supported <http_command>s) OK	+UHTTTPC: (0-3),(0-5) OK
URC		+UUHTTTPCR: <profile_id>,<http_command>,<http_result>	+UUHTTTPCR: 0,1,1

26.2.3 Defined values

Parameter	Type	Description
<profile_id>	Number	HTTP profile identifier, in range 0-3
<http_command>	Number	<ul style="list-style-type: none"> • 0: HEAD command; issue an HEAD request to the HTTP server. <ul style="list-style-type: none"> o <param1>: not allowed o <param2>: not allowed o <param3>: not allowed • 1: GET command; perform a GET request to the HTTP server. <ul style="list-style-type: none"> o <param1>: not allowed o <param2>: not allowed o <param3>: not allowed • 2: DELETE command; send a DELETE request to the HTTP server. <ul style="list-style-type: none"> o <param1>: not allowed o <param2>: not allowed o <param3>: not allowed • 3: PUT command; perform a PUT request to the HTTP server. <ul style="list-style-type: none"> o <param1>: filesystem filename (string); the maximum length is 47 characters. It is a mandatory string representing the file system filename to be sent to the HTTP server within the PUT request. o <param2>: not allowed o <param3>: not allowed • 4: POST a file command; issue a POST request for sending a file to the HTTP server. <ul style="list-style-type: none"> o <param1>: filesystem filename (string); the maximum length is 47 characters. It is a mandatory string representing the file system filename to be sent to the HTTP server within the POST request. o <param2>: HTTP Content-Type identifier (number); the range is 1-6. It is a mandatory numeric parameter representing the HTTP Content-Type identifier <ul style="list-style-type: none"> - 0: application/x-www-form-urlencoded - 1: text/plain



Parameter	Type	Description
		<ul style="list-style-type: none"> - 2: application/octet-stream - 3: multipart/form-data - 4: application/json - 5: application/xml - 6: user defined with <param3> <ul style="list-style-type: none"> o <param3>: used only when <param2> is set to user defined Content-Type. The maximum length is 64 characters <ul style="list-style-type: none"> • 5: POST data command; send a POST request to the HTTP server using the data specified in <param1> parameter <ul style="list-style-type: none"> o <param1>: data (string); the maximum length is 128 bytes. It is a mandatory string representing the data to be sent to the HTTP server with the POST request. The data must be formatted according to the Content-Type specified in <param2> parameter. o <param2>: HTTP Content-Type identifier (number); the range is 1-6. It is a mandatory numeric parameter representing the HTTP Content-Type identifier <ul style="list-style-type: none"> - 0: application/x-www-form-urlencoded - 1: text/plain - 2: application/octet-stream - 3: multipart/form-data - 4: application/json - 5: application/xml - 6: user defined with <param3> o <param3>: used when <param2> is set to 6 (user defined content type). The maximum length of the user defined content type is 64 characters.
<path>	String	Path of HTTP server resource; the maximum length is 128 characters.
<filename>	String	Filename where the HTTP server response will be stored; the maximum length is 47 characters. If the file already exists, it will be overwritten. If <filename> is an empty string (""), the default "http_last_response_<profile_id>" filename will be used.
<param1>	String	Content depends on the related <http_command> (see above).
<param2>	Number	Content depends on the related <http_command> (see above).
<param3>	String	Content depends on the related <http_command> (see above).
<http_result>	Number	<ul style="list-style-type: none"> • 0: fail • 1: success

26.2.4 Notes

- The +UHTTPC command has a default timeout setting set to 180 s. The timeout is counted from the last successful network read or send operation performed by the HTTP application, so in a real timeout case the application might be executing a command more than 180 s.
- The data string must not exceed the maximum length of 128 bytes and not all of the ASCII charset can be used. Allowed ASCII characters are: 0x20 (space), 0x21 and from 0x23 to 0xFF. Substantially all of the alphanumeric set, symbols and extended ASCII charset from 0x80 to 0xFF. The control characters from 0x00 to 0x1F (included) and the 0x22 character, quotation mark ("), are forbidden.
- If <http_command>=4 (POST a file), then the module automatically adds the following HTTP header:
Content-Disposition: form-data; name="file_post"; filename=...

Where "..." is replaced by the filename specified in <param3>

LISA-U / LEON-G

- HTTP content types 4, 5 and 6 are not supported.

SARA-G340-00S / SARA-G350-00S / SARA-G350-00X

- HTTP content types 4, 5 and 6 are not supported.

SARA-G340-01S / SARA-G350-01S / SARA-G350-01B

- HTTP Content-Type identifier 6 is not supported.

26.3 HTTP protocol error +UHTTPER

+UHTTPER						
Modules	LEON-G SARA-G340 SARA-G350 LISA-U SARA-U					
Attributes	Syntax	PIN required	Settings saved	Can be aborted	Response time	Error reference
	full	No	No	No	< 10s	Appendix A.1

26.3.1 Description

Retrieves the error class and code of the latest HTTP operation on the specified HTTP profile.

26.3.2 Syntax

Type	Syntax	Response	Example
Set	AT+UHTTPER=<profile_id>	+UHTTPER: <profile_id>,<error_class>,<error_code> OK	AT+UHTTPER=1 +UHTTPER: 1,0,0 OK

26.3.3 Defined values

Parameter	Type	Description
<profile_id>	Number	HTTP profile identifier, in range 0-3
<error_class>	Number	List of the allowed values is available in Appendix A.1
<error_code>	Number	Value of class-specific error codes (reply code if class is 0). When <error_class>=10 (wrong HTTP API usage), the allowed <error_code>; values are listed in Appendix A.1.2

27. SMTP

u-blox proprietary SMTP AT commands provide the capability of sending text mails over the available data connection, with support of some header fields and attachments transparently retrieved from the file system.

A PSD or CSD connection must be activated before using SMTP AT commands: refer to [+UCSD](#), [+UCSDA](#) and [+UCSND](#) AT commands for establishing a CSD connection and to [+UPSD](#), [+UPSDA](#) and [+UPSND](#) AT commands for establishing a PSD connection.

When these commands report an error which is not a +CME ERROR, the error code can be queried using the [+USMTPER](#) AT command.

27.1 SMTP control +USMTP

+USMTP						
Modules	LEON-G SARA-G340 SARA-G350					
Attributes	Syntax	PIN required	Settings saved	Can be aborted	Response time	Error reference
	full	No	No	No	-	+CME Error

27.1.1 Description

Sets up the necessary parameters for SMTP service, or resets parameters to the factory-programmed value. A set command for each <param_tag> needs to be issued to configure the SMTP setting. The read command returns the current setting of all the SMTP parameters, one per line (i.e. the SMTP profile).

The SMTP parameter values specified with this command are all volatile (not stored in non-volatile memory).



In the set command, if only the first parameter is issued, the module resets the parameter to the factory-programmed value.



The port used by the SMTP client cannot be configured. The default port (25) is used.

27.1.2 Syntax

Type	Syntax	Response	Example
Set	AT+USMTP=<param_tag>[,<param_val1>[,<param_val2>]]	OK	AT+USMTP=0,"151.9.37.66" OK AT+USMTP=0 OK
Read	AT+USMTP?	+USMTP: 0,<param_val1_0> ... +USMTP: 6,<param_val1_6>,<param_val2_6> OK	+USMTP: 0,"69.147.102.58" +USMTP: 1,"" +USMTP: 2,"username" +USMTP: 4,1 +USMTP: 5,0 +USMTP: 6,0,0 OK
Test	AT+USMTP=?	+USMTP: (list of supported <param_tag>s) OK	+USMTP: (0-6) OK

27.1.3 Defined values

Parameter	Type	Description
<param_tag>	Number	<ul style="list-style-type: none"> • 0: SMTP server IP address <ul style="list-style-type: none"> o <param_val1> is the string representing the SMTP server IP address expressed in dotted decimal notation form o <param_val2> parameter is not allowed

Parameter	Type	Description
		<ul style="list-style-type: none"> • 1: SMTP server name <ul style="list-style-type: none"> o <param_val1> is the string of SMTP server name (e.g. "smtp.server.com"). The maximum length is 128 characters o <param_val2> parameter is not allowed • 2: username <ul style="list-style-type: none"> o <param_val1> is the string representing the user name (the maximum length is 30 characters) for the SMTP login procedure if the authentication is used o <param_val2> parameter is not allowed • 3: password <ul style="list-style-type: none"> o <param_val1> is the string representing the password (the maximum length is 30 characters) for the SMTP login procedure if the authentication is used o <param_val2> parameter is not allowed • 4: authentication type <ul style="list-style-type: none"> o <param_val1> is the SMTP authentication method (if any): <ul style="list-style-type: none"> - 0 (default value): no authentication - 1: plain authentication - 2: login authentication o <param_val2> parameter is not allowed • 5: inactivity timeout <ul style="list-style-type: none"> o <param_val1> is the inactivity timeout period expressed in seconds, from 0 to 86400 s. 0 means no timeout (the SMTP session will not be terminated in the absence of incoming traffic); the default value is 30 s o <param_val2> parameter is not allowed • 6: time zone, used for the date header field of mails <ul style="list-style-type: none"> o <param_val1> numeric parameter representing the value of hour differential, in range [-12; 12] (the default value is 0) o <param_val2> numeric parameter representing the value of minute differential, in range [0; 59] (the default value is 0). This is a mandatory parameter if <param_tag>=6 and <param_val1> is specified.
<param_val1>		Type and content depend on <param_tag> parameter (see details above). If <param_val1> is not specified, the value for the corresponding <param_tag> is reset
<param_val2>		Type and content depend on related <param_tag> parameter (see details above)

27.1.4 Notes

- <param_tag>=0 and <param_tag>=1 are mutually exclusive. If <param_val1> value for <param_tag>=0 is specified by the user, then value for <param_tag>=1 is reset or viceversa.

27.2 SMTP mail control +USMTPM

+USMTPM						
Modules	LEON-G SARA-G340 SARA-G350					
Attributes	Syntax	PIN required	Settings saved	Can be aborted	Response time	Error reference
	full	No	No	No	< 10s	Appendix A.1.1

27.2.1 Description

Sets (or resets) the necessary parameters for envelope and body of a mail for the subsequent transmission via SMTP protocol. To configure the settings for envelope and body of mail the set command needs to be issued for each <param_tag>.

In the set command, if none parameter is issued, the module resets all the internal SMTP buffers to create a new mail.

27.2.2 Syntax

Type	Syntax	Response	Example
Set	AT+USMTPM[=<param_tag>,<param_val1>[,<param_val2>,<param_val3>]]	OK	AT+USMTPM=0,"ugo.rossi@u-blox.com" OK
			AT+USMTPM



Type	Syntax	Response	Example
Enhanced mode	AT+USMTPM=6 @<mail text><Ctrl-Z>	OK	OK AT+USMTPM=6 @<mail text><Ctrl-Z>
Test	AT+USMTPM=?	+USMTPM: (list of supported<param_tag>s) OK	OK +USMTPM: (0-5) OK

27.2.3 Defined values

Parameter	Type	Description
<param_tag>	Number	<ul style="list-style-type: none"> • 0: Set the mail sender address <ul style="list-style-type: none"> o <param_val1> mandatory parameter representing the text string of the sender address. It must be in the form "local_part@domain" and not exceed 64 characters o <param_val2> parameter is not allowed o <param_val3> parameter is not allowed • 1: Set the "Replay-To" field <ul style="list-style-type: none"> o <param_val1> mandatory parameter representing the text string of the address which reply should be sent to. It must be in form "local_part@domain" and not exceed 64 characters o <param_val2> parameter is not allowed o <param_val3> parameter is not allowed • 2: Add the mail receiver. Up to 10 different recipient addresses can be added for each new mail. <ul style="list-style-type: none"> o <param_val1> mandatory parameter representing recipient address text string. It must be in form "local_part@domain" and not exceed 64 characters. o <param_val2> parameter is not allowed o <param_val3> parameter is not allowed • 3: Set the mail subject <ul style="list-style-type: none"> o <param_val1> mandatory parameter representing the text string of the mail subject. o <param_val2> parameter is not allowed o <param_val3> parameter is not allowed • 4: Set the mail text. <ul style="list-style-type: none"> o <param_val1> mandatory parameter representing the text string of the mail text. o <param_val2> parameter is not allowed o <param_val3> parameter is not allowed • 5: Add an attachment. The attachment must be a file stored in the file system and accessible by the SMTP client. Up to 10 attachments can be added for each new mail. <ul style="list-style-type: none"> o <param_val1> mandatory textual parameter representing the attachment file name o <param_val2> mandatory numeric parameter of the media type and it can be: <ul style="list-style-type: none"> - 0: undefined media type - 1: text media type - 2: image media type - 3: audio media type - 4: video media type - 5: application media type o <param_val3> mandatory parameter, text string of media sub-type • 6: Set mail text in enhanced mode: it is possible to write text messages up to 4096 bytes. After having issued the AT+USMTPM=6 command a '@' prompt will be displayed. After this prompt it is possible to write the mail text. To finish the input send the special character Ctrl-Z (0x1A). Anyway if the total length of 4096 characters is reached, the command automatically exits from the input mode. <ul style="list-style-type: none"> o <param_val1>, <param_val2> and <param_val3> are not used.
<param_val1>	String	Type and content depend on <param_tag> (see details above). If <param_val1> is not specified, the value for the corresponding <param_tag> is reset
<param_val2>	Number	Type and content depend on related <param_tag> (see details above)
<param_val3>	String	Type and content depend on related <param_tag> (see details above)



27.2.4 Notes

- The mail subject must not exceed the maximum length of 64 bytes.
- The mail text must not exceed the maximum length of 512 bytes.
- The allowed ASCII characters for mail subject and text are: 0x20 (space), 0x21 and from 0x23 to 0xFF. Substantially all of the alphanumeric set, symbols and extended ASCII charset from 0x80 to 0xFF. The control characters from 0x00 to 0x1F (included) and the 0x22 character, quotation mark ("), are forbidden.
- In case <param_val2> = 0 (undefined media type), the empty string ("") can be used as input value for <param_val3> parameter.

27.3 SMTP command +USMTPC

+USMTPC						
Modules	LEON-G SARA-G340 SARA-G350					
Attributes	Syntax	PIN required	Settings saved	Can be aborted	Response time	Error reference
	full	No	No	No	< 10s	+CME Error

27.3.1 Description

Triggers the SMTP action corresponding to <smtp_command> parameter. The response indicates if sending the command request to SMTP process was successful or not. The final SMTP command result will be notified to the user via the +UUSMTPCR URC.

27.3.2 Syntax

Type	Syntax	Response	Example
Set	AT+USMTPC=<smtp_command>	OK	AT+USMTPC=1 OK
Test	AT+USMTPC=?	+USMTPC: (list of supported <smtp_command>s) OK	+USMTPC: (0-2) OK
URC		+UUSMTPCR: <smtp_command>,<smtp_result>[,<reject_rcpt_addr1>[,<reject_rcpt_addr2>[,...]]]	

27.3.3 Defined values

Parameter	Type	Description
<smtp_command>	Number	<ul style="list-style-type: none"> • 0: SMTP quit; terminates the SMTP session issuing a QUIT command, then closes the TCP connection with the SMTP server. • 1: SMTP connect; using the parameters of current SMTP profile (set via AT+USMTP command) connects to the SMTP server via TCP, reads its greeting and sends the HELO command, after which the handshake is complete, and the SMTP client is ready for sending mails. • 2: Send mail; sends the previously prepared mail (set up via AT+USMTPM command) to the connected SMTP server via the MAIL - RCPT - DATA commands sequence.
<smtp_result>	Number	Result code of SMTP operation <ul style="list-style-type: none"> • 0: Failure • 1: Success • 2: Partial success; this result code can be returned after AT+USMTPC=2 command (Send mail), when the mail has been delivered to some of the specified recipients only. In this case the list of mail addresses of rejected recipients follows.
<reject_rcpt_addrN>	String	Rejected recipient N, in the form "local_part@domain", in case the final result of AT+USMTPC=2 command (Send mail) is a Partial success.

27.4 SMTP error +USMTPER

+USMTPER						
Modules	LEON-G SARA-G340 SARA-G350					
Attributes	Syntax	PIN required	Settings saved	Can be aborted	Response time	Error reference
	full	No	No	No	-	SMTP Errors +CME Error

27.4.1 Description

Retrieves the error class and code of the last SMTP operation.

27.4.2 Syntax

Type	Syntax	Response	Example
Set	AT+USMTPER	+USMTPER: <error_class>,<error_code> OK	AT+USMTPER +USMTPER: 0,0 OK

27.4.3 Defined values

Parameter	Type	Description
<error_class>	Number	Value of error class; see Appendix A.1
<error_code>	Number	Value of class-specific error code (reply code if class is 0). The allowed values are listed in Appendix A.1.3

28. PING

PING service requires the user to define and activate a connection profile (either PSD or CSD) before executing the +UPING command. See [+UCSD](#), [+UCSDA](#) and [+UCSND](#) AT commands for establishing a CSD connection and [+UPSD](#), [+UPSDA](#) and [+UPSND](#) AT commands for establishing a PSD connection.

28.1 Ping command +UPING

+UPING						
Modules	LEON-G SARA-G340 SARA-G350 LISA-U200-01S LISA-U200-02S LISA-U200-52S LISA-U200-62S LISA-U200-82S LISA-U230 LISA-U260 LISA-U270 SARA-U					
Attributes	Syntax	PIN required	Settings saved	Can be aborted	Response time	Error reference
	full	No	No	No	-	+CME Error Ping Error

28.1.1 Description

The ping command is the common method to know if a remote host is reachable on the internet.

The ping functionality is based on the ICMP protocol (Internet Control Message Protocol), it is part of the Internet Protocol Suite as defined in RFC 792 [57]. ICMP messages are typically generated in response to errors in IP datagrams or for diagnostic / routing purposes.

The ping command sends an ICMP Echo-Request to the remote host and waits for its ICMP Echo-Reply. If the Echo-Reply packet is not received, it might mean that the remote host is not reachable.

The ping command could be used also to measure e.g. the RTT (Round Trip Time, the time needed by a packet to go to the remote host and come back) and the TTL (Time To Live, it is a value to understand how many gateway a packet has gone through).

The AT+UPING allows the user to execute a ping command from the modem to a remote peer.

The results of the ping command execution will be notified via +UUPING URC, or via +UUPINGER if any error occur while processing the command.

The +UUPING URC reports the result of the +UPING command when no error has occurred.

The +UUPINGER unsolicited indication is raised if an error is occurred while processing the +UPING command. The URC reports the code of occurred error (see [Ping error codes](#) to get the meanings of the error codes).



Some network operators may disallow ICMP packets traffic on their network, this means that the PING command may not work.



Some remote hosts might not reply to ICMP Echo-Request for security reasons (e.g. firewall settings).



Some remote hosts might not reply to ICMP Echo-Request if the data size of the Echo-Request is too big.



If a remote peer does not reply to an ICMP Echo-Request, it does not mean that for sure the peer cannot be reached in another way.



28.1.2 Syntax

Type	Syntax	Response	Example
Set	AT+UPING=<remote_host>[,<retry_num>,<p_size>,<timeout>,<ttl>]	OK	AT+UPING="www.google.com" OK
Test	AT+UPING=?	+UPING: "remote_host",(list of supported <retry_num>),(list of	+UPING: "remote_host",(1-64),(4-1460),(10-60000),(1-255)



Type	Syntax	Response	Example
		supported <p_size>),(list of supported <timeout>),(list of supported <ttl>) OK	OK
URC		+UUPING: <retry_num>,<p_size>,<remote_hostname>,<remote_ip>,<ttl>,<rtt>	+UUPING: 1,32,"www.l-google.com", "72.14.234.104",55,768
URC		+UUPINGER: <error_code>	+UUPINGER: 12

28.1.3 Defined values

Parameter	Type	Description
<remote_host>	String	IP address (dotted decimal representation) or domain name of the remote host <ul style="list-style-type: none"> Maximum Length: 128 characters
<retry_num>	Number	Indicates how many times iterate the ping command. <ul style="list-style-type: none"> Range: 1-64 Default: 4
<p_size>	Number	Size in bytes of the echo packet payload. <ul style="list-style-type: none"> Range: 4-1460 Default: 32
<timeout>	Number	The maximum time in milliseconds to wait for a Echo-Reply response. <ul style="list-style-type: none"> Range: 10-60000 Default: 5000
<ttl>	Number	The value of TTL to be set for the outgoing Echo-Request packet. In the URC it provides the TTL value received in the incoming packet <ul style="list-style-type: none"> Range: 1-255 Default: 32
<remote_hostname>	String	String representing the domain name (if available) of the remote host. If this information is not available, it will be an empty string (i.e. "").
<remote_ip>	String	String representing the remote host IP address in dotted decimal form.
<rtt>	Number	RTT value, the time elapsed in milliseconds before receiving the Echo-Reply response from the remote host. <ul style="list-style-type: none">  If the value of <rtt> is -1, it means that the timeout is elapsed (no response received).  Some network operators may return an ICMP Time Exceeded message when the remote host is not reachable, this causes an <rtt> = -2. In these cases the first ping request returns <rtt> = -1 (timeout elapsed) and the subsequent requests returns <rtt> = -2.
<error_code>	Number	The error occurred while processing the +UUPING command

28.1.4 Notes

LISA-U2 / SARA-U2

If the value of <rtt> is -2, it means that the TTL used in the ping request is too low.

LEON-G

The command uses the TCP/IP resources in an exclusive way. All the other TCP/IP operations executed after the execution of the +UPING command will wait for the execution of this command.



28.2 ICMP echo reply configuration +UDCONF=4

+UDCONF=4						
Modules	SARA-G340 SARA-G350					
	LISA-U200-01S LISA-U200-02S LISA-U200-52S LISA-U200-62S LISA-U200-82S LISA-U230 LISA-U260 LISA-U270 SARA-U					
Attributes	Syntax	PIN required	Settings saved	Can be aborted	Response time	Error reference
	full	No	No	No	-	+CME Error

28.2.1 Description

Enables/disables the ICMP echo reply (ping response).



Not all the network operators allow the ping traffic on their network.

28.2.2 Syntax

Type	Syntax	Response	Example
Set	AT+UDCONF=4,<icmp_echo_reply>	OK	AT+UDCONF=4,1 OK
Read	AT+UDCONF=4	+UDCONF: 4,<icmp_echo_reply> OK	AT+UDCONF=4 +UDCONF: 4,1 OK

28.2.3 Defined values

Parameter	Type	Description
<icmp_echo_reply>	Number	Enables or disables the ping response when a remote host performs a ping request to the module <ul style="list-style-type: none"> 0: ping response disabled (the module does not reply to remote pings) 1 (factory-programmed value): ping response enabled (the module replies to remote pings)

29. GNSS

29.1 NMEA

u-blox cellular modules support reading NMEA strings from the GNSS receiver through AT commands.

Before being able to read a specific NMEA string, it is necessary to activate the storage of the last value of that particular NMEA string. If storing a particular NMEA string was not activated, the response to the query will be "0, NULL". The last value of a specific NMEA string is saved in RAM and is made available even after the GNSS receiver switch off.

The NMEA standard differentiates between GPS, GLONASS and Multi-GNSS receivers using a different 'Talker ID'. Depending upon device model and system configuration, the u-blox receiver could output messages using any one of these Talker IDs.

By default, the receivers configured to support GPS, SBAS and QZSS use the 'GP' Talker ID, receivers configured to support GLONASS use the 'GL' Talker ID, receivers configured to support BeiDou use the 'GB' Talker ID and receivers configured for any combinations of multiple GNSS use the 'GN' Talker ID.

Even if the NMEA specification indicates that the GGA message is GPS specific, u-blox receivers support the output of a GGA message for each of the Talker IDs.

 As a factory-programmed setting, the cellular modules configure the GNSS receiver through +UGPS AT command to not provide the NMEA sentences.

 When reading an NMEA message, if the response value is "1, Not available" then the storing of the NMEA string is activated but this information has not been still sent to the user, if this persist check that the relative NMEA message is enabled. To enable it use the +UGUBX command (for further information see the UBX-CFG-MSG message in the u-blox GNSS Protocol Specification).

29.2 GNSS power management +UGPS

+UGPS						
Modules	LEON-G SARA-G340 SARA-G350 LISA-U1 LISA-U200-01S LISA-U200-02S LISA-U200-52S LISA-U200-62S LISA-U200-82S LISA-U230 LISA-U260 LISA-U270 SARA-U					
Attributes	Syntax	PIN required	Settings saved	Can be aborted	Response time	Error reference
	full	No	No	No	< 10s	+CME Error

29.2.1 Description

Switches on or off a u-blox GNSS receiver connected to the cellular module via a dedicated DDC (I²C) interface. For more details about the connection between cellular module and u-blox GNSS receiver see the corresponding module System Integration Manual.

Furthermore the command sets the aiding type to be used to enhance GNSS performance, e.g. decreasing Time To First Fix (TTFF), thus allowing to calculate the position in a shorter time with higher accuracy. The following aiding types are supported:

- Local aiding: the cellular module automatically uploads data such as ephemeris, almanac, last position, time, etc. from the GNSS receiver into its local memory, and restores back the GNSS receiver at the next power up of the GNSS module (if data are still valid, otherwise it uses GSM information such as country code for a rough position estimation)
- AssistNow Online: a connection profile (either PSD or CSD) must be defined and activated before selecting the AssistNow Online; see the +UGAOP and +UGSRV command descriptions. If CellLocate[®] is used, the first HTTP profile will be properly configured





- AssistNow Offline: a connection profile (either PSD or CSD) must be defined and activated before selecting the AssistNow Offline if the almanac file must be downloaded; see the [+UGAOF](#) and [+UGSRV](#) command descriptions.

 LEON-G

The AssistNow Offline enables AID-ALPSRV UBX message on all the GNSS communication ports.

- AssistNow Autonomous: based on a broadcast ephemeris downloaded from the satellite (or obtained by AssistNow Online) the receiver can autonomously generate an accurate satellite orbit representation («AssistNow Autonomous data») that is usable for navigation much longer than the underlying broadcast ephemeris was intended for. This makes downloading new ephemeris or aiding data for the first fix unnecessary for subsequent start-ups of the receiver.

 If using CellLocate[®] and HTTP commands, the HTTP profiles in the range 1-3 must be used.

 To establish a CSD connection see the [+UCSD](#), [+UCSDA](#) and [+UCSND](#) AT commands while to establish a PSD connection see the [+UPSD](#), [+UPSDA](#) and [+UPSND](#) AT commands.

 The AssistNow Autonomous feature may be not fully supported on all Multi-GNSS receivers. For more details on AssistNow Autonomous feature see the corresponding u-blox-GNSS Receiver Description.

For a more detailed description on aiding modes and possible suggestions, see the GNSS Implementation Application Note [\[52\]](#).

It is possible to combine different aiding modes: to enable them the sum of the <mode> value of the interested aiding modes is needed (e.g.: aiding <mode>=3 means local aiding plus AssistNow Offline). Moreover it is also possible to switch from one aiding mode to another one without powering off the GNSS receiver. If the following sequence is provided (AT+UGPS=1,1 and then AT+UGPS=1,5) at the beginning the GNSS receiver will power on with local aiding support and after the second command will be added the AssistNow Online. After the second command the local aiding is not restarted, therefore the [+UUGIND](#) URC for it will not be sent again.

The latest u-blox GNSS products are multi-GNSS receivers capable of receiving and processing signals from multiple Global Navigation Satellite Systems (GNSS). u-blox concurrent GNSS receivers are multi-GNSS receivers that can acquire and track satellites from more than one GNSS system at the same time, and utilize them for positioning. The <GNSS_systems> parameter configures the GNSS receiver into the required mode of operation. It is possible to combine different GNSS systems. The combinations of systems, which can be configured simultaneously depends on the receivers capability to receive several carrier frequencies. See the corresponding GNSS receiver Data Sheet for the supported GNSS systems. If the Assisted GNSS unsolicited indication is enabled, the [+UUGIND](#) URC will provide the current activated combinations of systems.

29.2.2 Syntax

Type	Syntax	Response	Example
Set	AT+UGPS=<mode>[,<aid_mode>[,<GNSS_systems>]]	OK	AT+UGPS=1,0,1 OK
Read	AT+UGPS?	+UGPS: <mode>[,<aid_mode>[,<GNSS_systems>]] OK	+UGPS: 1,0,1 OK
Test	AT+UGPS=?	+UGPS: (list of supported <mode>s), (list of supported <aid_mode>),(list of supported <GNSS_systems>) OK	+UGPS: (0-1),(0-15),(1-127) OK

29.2.3 Defined values

Parameter	Type	Description
<mode>	Number	<ul style="list-style-type: none"> • 0 (default value): GNSS receiver powered off • 1: GNSS receiver powered on
<aid_mode>	Number	Supported aiding modes; the parameter is mandatory if <mode>=1; all these allowed values can be combined together



Parameter	Type	Description
		<ul style="list-style-type: none"> • 0 (default value): no aiding • 1: automatic local aiding • 2: AssistNow Offline • 4: AssistNow Online • 8: AssistNow Autonomous
<GNSS_systems>	Number	Supported GNSS types; the parameter is optional and the allowed values can be combined together. The default value is 3 (GPS+SBAS): <ul style="list-style-type: none"> • 1: GPS • 2: SBAS • 4: Galileo • 8: BeiDou • 16: IMES • 32: QZSS • 64: GLONASS

29.2.4 Notes

- To know the allowed combinations of GNSS type for <GNSS_systems> see the corresponding GNSS receiver documentation.
- An error message is provided in the following cases:
 - o <mode>, <aid_mode> or <GNSS_systems> values are out of range
 - o <mode> is set to 1 without <aid_mode> value
 - o Attempt to power off the GNSS when it is already off
 - o The value of <aid_mode> to be set is equal to the current GNSS aiding mode and the value of <GNSS_systems> to be set is equal to the last requested <GNSS_systems>
- The parameter <GNSS_systems> is displayed in the information text response of the read command only if the connected GNSS receiver supports Multi-GNSS

LISA-U / SARA-G300-00S / SARA-G310-00S / SARA-G340-00S / SARA-G350-00S / SARA-G350-00X / LEON-G

- The parameter <GNSS_systems> is not supported.

29.3 Assisted GNSS unsolicited indication +UGIND

+UGIND						
Modules	LEON-G SARA-G340 SARA-G350					
	LISA-U1 LISA-U200-01S LISA-U200-02S LISA-U200-52S LISA-U200-62S LISA-U200-82S LISA-U230 LISA-U260 LISA-U270 SARA-U					
Attributes	Syntax	PIN required	Settings saved	Can be aborted	Response time	Error reference
	full	No	No	No	-	+CME Error

29.3.1 Description

Enables or disables sending of URCs from MT to TE in the case of GNSS aiding operations. The <mode> parameter controls the processing of URCs specified within this command.

The URC returns the result of an assisted GNSS operation. This information is sent to all the interfaces. The URC is provided only if one or more aiding modes are enabled (for more details see the [+UGPS](#) and [+UGAOP](#) command descriptions).

There can be more than a +UUGIND URC for a single aiding operation: the +UUGIND is reported for each error. For instance if the local aiding is enabled and there are no space left in the file system after +UGPS=0, there will be an error for every failure writing on FFS.

The commands +UGAOS=0 and +UGAOS=1 both relate to the GNSS local aiding, so the unsolicited message will be +UUGIND=1,x in both cases.



Local aiding and AssistNow Autonomous will produce URC both after GNSS power on and before GNSS power off because some data are transferred from the GNSS receiver to the cellular module.

If the connected GNSS receiver is Multi-GNSS then an additional +UUGIND=0,<GNSS_systems> URC for the currently activated GNSS systems is displayed.

**LEON-G**

The URCs during GNSS power down phase are generated between the power off command (+UGPS=0) and the actual switch off (OK result code).

29.3.2 Syntax

Type	Syntax	Response	Example
Set	AT+UGIND=<mode>	OK	AT+UGIND=1 OK
Read	AT+UGIND?	+UGIND: <mode> OK	+UGIND: 1 OK
Test	AT+UGIND=?	+UGIND: (list of supported <mode>'s) OK	+UGIND: (0-1) OK
URC		Current activated GNSS system: +UUGIND: 0,<GNSS_systems> GNSS aiding status: +UUGIND: <aid_mode>,<result>	+UUGIND: 0,3 +UUGIND: 4,5

29.3.3 Defined values

Parameter	Type	Description
<mode>	Number	URC configuration: <ul style="list-style-type: none"> 0 (default value): disabled 1: enabled
<aid_mode>	Number	Provides the supported aiding mode <ul style="list-style-type: none"> 0: GNSS system(s) 1: automatic local aiding 2: AssistNow Offline 4: AssistNow Online 8: AssistNow Autonomous
<GNSS_systems>	Number	Current activated GNSS types; the allowed values can be combined together: <ul style="list-style-type: none"> 1: GPS 2: SBAS 4: Galileo 8: BeiDou 16: IMES 32: QZSS 64: GLONASS
<result>	Number	Represents the result of the aiding operation: <ul style="list-style-type: none"> 0: No error 1: Wrong URL (for AssistNow Offline) 2: HTTP error (for AssistNow Offline) 3: Create socket error (for AssistNow Online) 4: Close socket error (for AssistNow Online) 5: Write to socket error (for AssistNow Online) 6: Read from socket error (for AssistNow Online) 7: Connection/DNS error (for AssistNow Online) 8: File system error 9: Generic error 10: No answer from GNSS (for local aiding and AssistNow Autonomous) 11: Data collection in progress (for local aiding)

Parameter	Type	Description
		<ul style="list-style-type: none"> • 12: GNSS configuration failed (for AssistNow Autonomous) • 13: RTC calibration failed (for local aiding) • 14: feature not supported (for AssistNow Autonomous) • 15: feature partially supported (for AssistNow Autonomous) • 16: authentication token missing (required for aiding for u-blox M8 and future versions)

29.4 GNSS profile configuration +UGPRF

+UGPRF						
Modules	LEON-G SARA-G340 SARA-G350					
	LISA-U1 LISA-U200-01S LISA-U200-02S LISA-U200-52S LISA-U200-62S LISA-U200-82S LISA-U230 LISA-U260 LISA-U270 SARA-U					
Attributes	Syntax	PIN required	Settings saved	Can be aborted	Response time	Error reference
	full	No	<i>NVM</i>	No	-	<i>+CME Error</i>

29.4.1 Description

Configures the data flow to and from a u-blox GNSS receiver connected to the cellular module. The data flow is possible to and from the:

- UART (via multiplexer)
- USB
- Over the air to a remote host: To send data over the air an internet connection must be active and there must be at least one free TCP socket (the GNSS shares the socket pool with the other applications). Setting up an Internet connection and network registration is not part of this command and must be handled by the user separately from this command; refer to *+UCSD*, *+UCSDA* and *+UCSND* AT commands for establishing a CSD connection and to *+UPSD*, *+UPSDA* and *+UPSND* AT commands for establishing a PSD connection
- Into a file on the cellular module: A file with GNSS data can be accessed via *+ULSTFILE* command. The file name is automatically chosen by the cellular module as a unique ID based on date and time or a further incremental number (e.g. "GPS_200910061500" or "GPS_20091006_001" according to the used cellular module). When the files size reaches 500 kB the file is closed and no more data is saved. It is possible to save further data by restarting the GNSS (this will create a new file)

It is possible to send GNSS data to multiple destinations at the same time by summing the <GNSS_I/O_configuration> values of each required destinations (e.g. if AT+UGPRF=6 the data will be sent on multiplexer and stored in a file in the file system).

The messages to be output by the u-blox GNSS receiver need to be activated separately with UBX-CFG-MSG configuration messages according to the GNSS Receiver Protocol Specification.

 It is not possible to select the GNSS data flow to and from USB and multiplexer concurrently.

 The configuration of the GNSS profile must be performed only when GNSS is switched off, otherwise an error message will be displayed.

29.4.2 Syntax

Type	Syntax	Response	Example
Set	AT+UGPRF=<GNSS_I/O_configuration>[, <IP Port>,<server address string>]	OK	AT+UGPRF=0 OK
Read	AT+UGPRF?	+UGPRF: <GNSS_I/O_configuration>,<IP port>,<server address string> OK	+UGPRF: 0,0,"" OK
Test	AT+UGPRF=?	+UGPRF: (list of supported <GNSS_I/O_configuration>),(list of supported <IP port>),<server address string> OK	+UGPRF: (0-127),(0-65535),"addr" OK

29.4.3 Defined values

Parameter	Type	Description
<GNSS_IO_configuration>	Number	<ul style="list-style-type: none"> 0 (default value and factory-programmed value): no data flow to multiplexer, file or IP address 1: GNSS data flow to and from USB 2: GNSS data flow to and from multiplexer 4: GNSS data flow saved to file 8: GNSS data flow over the air to an Internet host 16: GNSS data ready function 32: GNSS RTC sharing function 64: Reserved
<IP port>	Number	IP port of the server where the GNSS data are sent (default value and factory-programmed value: 0). If GNSS data flow over the air is enabled the parameter is mandatory otherwise is forbidden
<server address string>	String	Address string of the server where the GNSS data are sent (default value and factory-programmed value: ""). If GNSS data flow over the air is enabled the parameter is mandatory otherwise is forbidden. The address could be provided in both URL or IP format and the maximum length of the string is 47 characters.

29.4.4 Notes

LEON-G

- The server address string parameter accepts only IP address in dotted notation, thus it has a maximum length of 15 characters.
- A delay time of at least 3 s after the power on is required before issuing this command.
- The USB interface is not supported.
- UBX-AID messages are not passed over the multiplexer if AssistNow Online, AssistNow Offline or Local Aiding is enabled (see [AT+UGPS](#) command description).

SARA-G350 / SARA-G340

- The GNSS data flow on the multiplexer channel is only in output toward the cellular module; the input to the GNSS receiver is not supported.
- The USB interface is not supported.

29.5 AssistNow Online configuration +UGAOP

+UGAOP						
Modules	LEON-G SARA-G340 SARA-G350 LISA-U1 LISA-U200-01S LISA-U200-02S LISA-U200-52S LISA-U200-62S LISA-U200-82S LISA-U230 LISA-U260 LISA-U270 SARA-U					
Attributes	Syntax	PIN required	Settings saved	Can be aborted	Response time	Error reference
	full	No	NVM	No	-	+CME Error

29.5.1 Description

Configures the network connection to an AssistNow Online server. Use of this command is only necessary if changes to the factory-programmed configuration are required.

The AssistNow Online server is accessed with the User Datagram Protocol (UDP). The GNSS shares the socket pool with the other applications, to execute AssistNow the cellular module will try to open a new socket without dropping any opened socket, if there is no socket available then the GNSS will start and no aiding operation is performed. By default, the cellular module connects to u-blox' AssistNow Online server. The authentication on u-blox' AssistNow Online server is done automatically (without giving u-blox any information that could be used to identify the customer and/or end user); username and passwords are not required. The access to a proxy server is possible.

Three different modes of operation are supported:

- AssistNow Online data are automatically downloaded from the server when the GNSS receiver is started up (i.e. with command +UGPS and <GPS mode>=1 and <aid_mode>=4)



- AssistNow Online data are only requested upon the reception of a +UGAOS AT command
- AssistNow Online data are kept alive. This is done by periodically (every 2 hours) accessing the AssistNow Online to keep the ephemeris alive.



Setting up Internet connection and network registration is not part of this command and must be handled by the user separately to this command; refer to [+UCSD](#), [+UCSDA](#) and [+UCSND](#) AT commands for establishing a CSD connection and to [+UPSD](#), [+UPSDA](#) and [+UPSND](#) AT commands for establishing a PSD connection.



Where supported, it is preferred to use the [+UGSRV](#) AT command.

29.5.2 Syntax

Type	Syntax	Response	Example
Set	AT+UGAOP=<hostname>,<server port>,<latency>,<mode>	OK	AT+UGAOP="eval1-les.services.u-blox.com",46434,1000,0 OK
Read	AT+UGAOP?	+UGAOP: <hostname>,<server port>,<latency>,<mode> OK	+UGAOP: "eval1-les.services.u-blox.com",46434,1000,0 OK

29.5.3 Defined values

Parameter	Type	Description
<hostname>	String	Host name of the server (factory-programmed value: eval1-les.services.u-blox.com); the maximum length is 47 characters
<server port>	Number	Value in the range 0 - 65535. (factory-programmed value: 46434)
<latency>	Number	Expected network latency value from AssistNow Online server to client, in seconds. The range goes from 0 to 10000 ms. (factory-programmed value: 1000 ms)
<mode>	Number	Mode of operation of AssistNow Online data management <ul style="list-style-type: none"> • 0 (factory-programmed value): AssistNow Online data are downloaded at GNSS receiver power up • 1: AssistNow Online data automatically kept alive • 2: manual AssistNow Online data download

29.5.4 Notes

LEON-G

- A delay time of at least 3 s after the power on is required before issuing this command.

29.6 AssistNow Offline configuration +UGAOF

+UGAOF						
Modules	LEON-G SARA-G340 SARA-G350 LISA-U1 LISA-U200-01S LISA-U200-02S LISA-U200-52S LISA-U200-62S LISA-U200-82S LISA-U230 LISA-U260 LISA-U270 SARA-U					
Attributes	Syntax	PIN required	Settings saved	Can be aborted	Response time	Error reference
	full	No	NVM	No	-	+CME Error

29.6.1 Description

Configures the network connection to an AssistNow Offline server. Use of this command is only necessary if changes to the factory-programmed configuration are required.

Access to an AssistNow Offline server is done with HTTP/1.1. The GNSS shares the socket pool with the other applications, to execute AssistNow Offline the cellular module will try to open a new socket without dropping any opened socket, if there is no socket available then the GNSS will start and no aiding operation is performed. By default, the cellular module connects to the 14 day file on the u-blox' AssistNow Offline server.



 Setting up Internet connection and network registration is not part of this command and must be handled by the user separately from this command.

 Where supported, it is preferred to use the **+UGSRV** AT command.

29.6.2 Syntax

Type	Syntax	Response	Example
Set	AT+UGAOF=<file_url>,<reserved>,<retry timeout>,<max_retry_attempts>	OK	AT+UGAOF="http://alp.u-blox.com/current_14d.alp",0,1,3 OK
Read	AT+UGAOF?	+UGAOF: <file_url>,0,<retry timeout>,<max_retry_attempts> OK	+UGAOF: "http://alp.u-blox.com/current_14d.alp",0,1,3 OK

29.6.3 Defined values

Parameter	Type	Description
<file_url>	String	URL of AssistNow Offline file (the maximum length is 255 characters including "http://"). Allows choosing the size/validity of the file. The factory-programmed value is http://alp.u-blox.com/current_14d.alp
<Reserved>		RFU
<Retry Timeout>	Number	Timeout in minutes after a failed download for the next download attempt (0 ... 999) (factory-programmed value: 1)
<max_retry_attempts>	Number	Maximum number of attempts in case of failed download (0-5); the factory-programmed value is 3.

29.6.4 Notes

LEON-G

- A delay time of at least 3 s after the power on is required before issuing this command.

29.7 Aiding server configuration +UGSRV

+UGSRV						
Modules	SARA-G340-01S SARA-G350-01B SARA-G350-01S SARA-U					
Attributes	Syntax	PIN required	Settings saved	Can be aborted	Response time	Error reference
	full	No	<i>NVM</i>	No	-	<i>+CME Error</i>

29.7.1 Description

Configures the network connection to a Multi GNSS Assistance (MGA) server. These parameters are saved in NVM and are applied at the next GNSS power cycle. The MGA server is accessed with the HTTP. This assistance mode requires a packet data connection to exchange information with u-blox servers. By default, the cellular module connects to u-blox' primary MGA server; if the connection fails then the cellular module connects to u-blox' secondary MGA server. Authorization tokens are used as a means of authorizing access to the u-blox services and for gathering anonymised statistics. To obtain a token customers should use the form in <http://www.u-blox.com/services-form.html>.

 Setting up Internet connection and network registration is not part of this command and must be handled by the user separately to this command; see **+UCSD**, **+UCSDA** and **+UCSND** AT commands for establishing a CSD connection and **+UPSD**, **+UPSDA** and **+UPSND** AT commands for establishing a PSD connection.

29.7.2 Syntax

Type	Syntax	Response	Example
Set	AT+UGSRV=<mga_primary_server>,<mga_secondary_server>,<auth_>	OK	AT+UGSRV="cell-live1.services.u-blox.com","cell-live2.services.u-



Type	Syntax	Response	Example
	token>[,<days>[,<period>[,<resolution>[,<GNSS_types>[,<mode>[,<datatype>]]]]]]		blox.com","123456789abcdefghijklm", 14,4,1,65,0,1 OK
Read	AT+UGSRV?	+UGSRV: <mga_primary_server>,<mga_secondary_server>,<auth_token>,<days>,<period>,<resolution>,<GNSS_types>,<mode>,<datatype> OK	+UGSRV: "cell-live1.services.u-blox.com","cell-live2.services.u-blox.com","123456789abcdefghijklm", 14,4,1,65,0,1 OK
Test	AT+UGSRV=?	+UGSRV: <mga_primary_server>,<mga_secondary_server>,<auth_token>,(list of supported <days>s),(list of supported <period>s),(list of supported <resolution>s),(list of supported <GNSS_types>s),(list of supported <mode>s),(list of supported <datatype>s) OK	+UGSRV: "srv1","srv2","token",(1,2,3,5,7,10,14),(1-5),(1-3),(1,64,65),(0-2),(0-15) OK

29.7.3 Defined values

Parameter	Type	Description
<mga_primary_server>	String	Host name of the primary u-blox M8 server; the maximum length is 255 characters. The default and factory-programmed value is "cell-live1.services.u-blox.com"
<mga_secondary_server>	String	Host name of the secondary u-blox M8 server; the maximum length is 255 characters. The default and factory-programmed value is "cell-live2.services.u-blox.com"
<auth_token>	String	Authentication Token for u-blox M8 server access
<days>	Number	The number of days into the future the Offline data for u-blox 7 and previous version should be valid for. The allowed values are: 1, 2, 3, 5, 7, 10 and 14. The default and factory-programmed value is 14
<period>	Number	The number of weeks into the future the Offline data for u-blox M8 should be valid for. The range of the allowed values goes from 1 to 5. The default and factory-programmed value is 4
<resolution>	Number	The resolution of offline data for u-blox M8 <ul style="list-style-type: none"> • 1 (default and factory-programmed value): every day • 2: every other day • 3: every third day
<GNSS_types>	Number	Bitmask for combining the desired GNSS for the (offline) aiding <ul style="list-style-type: none"> • 1: GPS • 64: GLONASS The default and factory-programmed value is all (65)
<mode>	Number	Mode of operation of AssistNow Online data management <ul style="list-style-type: none"> • 0 (default and factory-programmed value): AssistNow Online data are downloaded at GNSS receiver power up • 1: AssistNow Online data automatically kept alive • 2: manual AssistNow Online data download
<datatype>	Number	Bitmask for combining the desired data types for the (online) aiding <ul style="list-style-type: none"> • 0: time • 1: position • 2: ephemeris • 4: almanac • 8: auxiliary The default and factory-programmed value is all (15)



29.8 GNSS aiding request command +UGAOS

+UGAOS						
Modules	LEON-G SARA-G340 SARA-G350 LISA-U1 LISA-U200-01S LISA-U200-02S LISA-U200-52S LISA-U200-62S LISA-U200-82S LISA-U230 LISA-U260 LISA-U270 SARA-U					
Attributes	Syntax	PIN required	Settings saved	Can be aborted	Response time	Error reference
	full	No	No	No	< 10s	+CME Error

29.8.1 Description

Triggers the manual download of AssistNow Online and AssistNow Offline data from the configured server in case automatic AssistNow operation is not enabled. The command returns only when the received data from the server are valid or an error occurs.

The command is also used to trigger the manual upload of local aiding data (e.g. ephemeris, almanac, last position, time, etc) from a u-blox GNSS receiver prior to shutting it down and to restore it into the receiver after the power up of the GNSS receiver (for more details refer to command +UGPS, [Chapter 29.2](#)).

29.8.2 Syntax

Type	Syntax	Response	Example
Set	AT+UGAOS=<aid_mode>	OK	AT+UGAOS=0 OK
Test	AT+UGAOS=?	AT+UGAOS: (list of supported <aid_mode>s) OK	+UGAOS: (0-8) OK

29.8.3 Defined values

Parameter	Type	Description
<aid_mode>	Number	<ul style="list-style-type: none"> 0: Upload of local aiding data from GNSS receiver to cellular module 1: Download of local aiding data from the cellular module to the GNSS receiver 2: AssistNow Offline file download request (file loaded into cellular module) 4: AssistNow Online data download request (data loaded into the GNSS receiver). This is only needed if AssistNow Online is not used with automatic operation 8: AssistNow autonomous Other values are reserved for future use

29.9 Send of UBX string +UGUBX

+UGUBX						
Modules	LEON-G SARA-G340 SARA-G350 LISA-U1 LISA-U200-01S LISA-U200-02S LISA-U200-52S LISA-U200-62S LISA-U200-82S LISA-U230 LISA-U260 LISA-U270 SARA-U					
Attributes	Syntax	PIN required	Settings saved	Can be aborted	Response time	Error reference
	full	No	No	No	< 10s	+CME Error

29.9.1 Description

Sends UBX protocol messages, embedded in an AT command, to a u-blox GNSS receiver. The command is transparent, that is the data is sent to the GNSS receiver without any check: it is up to the user to control if the UBX data is valid. The checksum in +UGUBX command string is ignored, this is calculated when data is sent to the GNSS receiver.

When the GNSS is off the UBX string is saved in RAM and, later, passed to the GNSS as configuration for "GNSS data ready" function when the GNSS is used. This message is used only if the GNSS receiver HW is unknown (newer than the cellular module FW). In this case the UBX checksum bytes must be filled correctly.



29.9.2 Syntax

Type	Syntax	Response	Example
Set	AT+UGUBX=<UBX String>	+UGUBX: <UBX String response> OK	AT+UGUBX="B562060108000106000 10000000017DA" +UGUBX: "B5620501020006010F38" OK

29.9.3 Defined values

Parameter	Type	Description
<UBX String>	String	UBX message in hexadecimal format. The messages can include spaces to simplify copy/paste from u-center separated with spaces, e.g. AT+UGUBX="B5 62 06 01 08 00 01 06 00 01 00 00 0 0 00 17 DA" (this is important when copying messages from u-center). The maximum length of <UBX string> is 110 bytes (spaces included)
<UBX String response>	String	The response message depends by the request sent: query/poll UBX messages will return the requested data in hexadecimal format, while configuration message will return the corresponding acknowledge or not-acknowledge. Refer to UBX protocol specification

29.9.4 Notes

- If a +UGUBX command triggers multiple strings answer only a single UBX string is returned. E. g. polling GPS Aiding Ephemeris Data (AID-EPH) is done by sending a single message to the receiver but returns 32 messages; only the first one is sent to AT interface.

LISA-U

- The command can only be used when the GNSS is used from the AT interface (power on by AT+UGPS=1, x).

LISA-U2xx-01S

- During hybrid positioning the command is used to configure "GNSS data ready" function.

LEON-G

- The command can only be used when the GNSS is used from the AT interface (power on by AT+UGPS=1, x).

29.10 GNSS indications timer +UGTMR

+UGTMR						
Modules	LEON-G SARA-G340 SARA-G350 LISA-U1 LISA-U200-01S LISA-U200-02S LISA-U200-52S LISA-U200-62S LISA-U200-82S LISA-U230 LISA-U260 LISA-U270 SARA-U					
Attributes	Syntax	PIN required	Settings saved	Can be aborted	Response time	Error reference
	full	No	No	No	< 10s	+CME Error

29.10.1 Description

Sets the date and time format. With the <time zone> parameter is possible to set the time zone value; the time and the date will be updated as the local time. With the action command is possible to synchronize the UTC timing.

29.10.2 Syntax

Type	Syntax	Response	Example
Set	AT+UGTMR=<time zone>	OK	AT+UGTMR=-1 OK
Read	AT+UGTMR?	+UGTMR: <time zone> OK	+UGTMR: -1 OK
Test	AT+UGTMR=?	+UGTMR: (list of supported <time zone>s)	+UGTMR: (-96 - 96) OK



Type	Syntax	Response	Example
		OK	

29.10.3 Defined values

Parameter	Type	Description
<time zone>	Number	Indicates the time zone value set by the user; the module can provide an error message if the offset has not been calculated. The factory-programmed time zone value is 0. <ul style="list-style-type: none"> -96, 96: defined range

29.10.4 Notes

- The time zone is expressed in quarters of hour.
- The time is updated with the current UTC time plus the time zone and the time zone is unchanged, for example:

Command	Response	Remarks
AT+UGTMR=-36	OK	The command returns "OK" and sets the new date and time if the GNSS has this information, otherwise a generic "ERROR" is returned.
AT+CCLK?	+CCLK: "12/05/23,21:54:21+00"	

LEON-G

- The command returns "OK" in case the GNSS has no time information, but in this case the date and time are not updated.
- The time zone range goes from -48 to 48.

29.11 Get GNSS Time and date +UGZDA

+UGZDA						
Modules	LEON-G SARA-G340 SARA-G350 LISA-U1 LISA-U200-01S LISA-U200-02S LISA-U200-52S LISA-U200-62S LISA-U200-82S LISA-U230 LISA-U260 LISA-U270 SARA-U					
Attributes	Syntax	PIN required	Settings saved	Can be aborted	Response time	Error reference
	full	No	NVM	No	< 10s	+CME Error

29.11.1 Description

Enables/disables the storing of the last value of NMEA \$ZDA messages, and get the current messaging state. If the <state> parameter is enabled, the last value of NMEA \$ZDA messages can be retrieved with the read command even when the GNSS is switched off.

The NMEA \$ZDA messages are volatile.

29.11.2 Syntax

Type	Syntax	Response	Example
Set	AT+UGZDA=<state>	OK	AT+UGZDA=1 OK
Read	AT+UGZDA?	+UGZDA: <state>,<\$ZDA msg> OK	+UGZDA: 1,\$GPZDA,142351.00,12,12,2013,00,00*66 OK +UGZDA: 0,NULL OK
Test	AT+UGZDA=?	+UGZDA: (list of supported <state>s) OK	+UGZDA: (0-1) OK



29.11.3 Defined values

Parameter	Type	Description
<state>	Number	<ul style="list-style-type: none"> 0 (factory-programmed value): disable the NMEA \$ZDA messages 1: enable the NMEA \$ZDA messages
<\$ZDA msg>	String	NMEA \$ZDA messages or "Not available" if the NMEA string is enabled, but this information has not been still sent to the user.

29.12 Get GNSS fix data +UGGGA

+UGGGA						
Modules	LEON-G SARA-G340 SARA-G350					
	LISA-U1 LISA-U200-01S LISA-U200-02S LISA-U200-52S LISA-U200-62S LISA-U200-82S LISA-U230 LISA-U260 LISA-U270 SARA-U					
Attributes	Syntax	PIN required	Settings saved	Can be aborted	Response time	Error reference
	full	No	NVM	No	< 10s	+CME Error

29.12.1 Description

Enables/disables the storing of the last value of NMEA \$GGA messages, and gets the current messaging state. If the <state> parameter is enabled, the last value of NMEA \$GGA messages can be retrieved with the read command even when the GNSS is switched off.

The NMEA \$GGA messages are volatile.

29.12.2 Syntax

Type	Syntax	Response	Example
Set	AT+UGGGA=<state>	OK	AT+UGGGA=1 OK
Read	AT+UGGGA?	+UGGGA: <state>,<\$GGA msg> OK	+UGGGA: 1,\$GPGGA,142351.00,,,,,0.00 ,99.99,,,,,*66 OK +UGGGA: 0,NULL OK
Test	AT+UGGGA=?	+UGGGA: (list of supported <state>s) OK	+UGGGA: (0-1) OK

29.12.3 Defined values

Parameter	Type	Description
<state>	Number	<ul style="list-style-type: none"> 0 (factory-programmed value): to disable the NMEA \$GGA messages 1: to enable the NMEA \$GGA messages
<\$GGA msg>	String	NMEA \$GGA messages or "Not available" if the NMEA string is enabled, but this information has not been still sent to the user.

29.13 Get geographic position +UGLL

+UGLL						
Modules	LEON-G SARA-G340 SARA-G350 LISA-U1 LISA-U200-01S LISA-U200-02S LISA-U200-52S LISA-U200-62S LISA-U200-82S LISA-U230 LISA-U260 LISA-U270 SARA-U					
Attributes	Syntax	PIN required	Settings saved	Can be aborted	Response time	Error reference
	full	No	<i>NVM</i>	No	< 10s	+CME Error

29.13.1 Description

Enables/disables the storing of the last value of NMEA \$GLL messages, and gets the current messaging state. If the <state> parameter is enabled, the last value of NMEA \$GLL messages can be retrieved with the read command even when the GNSS is switched off.

The NMEA \$GLL messages are volatile.

29.13.2 Syntax

Type	Syntax	Response	Example
Set	AT+UGLL=<state>	OK	AT+UGLL=1 OK
Read	AT+UGLL?	+UGLL: <state>,<\$GLL msg> OK	+UGLL: 1,\$GPGLL,,,,,142351.00,V, N*4A OK +UGLL: 0,NULL OK
Test	AT+UGLL=?	+UGLL: (list of supported <state>s) OK	+UGLL: (0-1) OK

29.13.3 Defined values

Parameter	Type	Description
<state>	Number	<ul style="list-style-type: none"> 0 (factory-programmed value): to disable the NMEA \$GLL messages 1: to enable the NMEA \$GLL messages
<\$GLL msg>	String	NMEA \$GLL messages or "Not available" if the NMEA string is enabled, but this information has not been still sent to the user.

29.14 Get number of GNSS satellites in view +UGGSV

+UGGSV						
Modules	LEON-G SARA-G340 SARA-G350 LISA-U1 LISA-U200-01S LISA-U200-02S LISA-U200-52S LISA-U200-62S LISA-U200-82S LISA-U230 LISA-U260 LISA-U270 SARA-U					
Attributes	Syntax	PIN required	Settings saved	Can be aborted	Response time	Error reference
	full	No	<i>NVM</i>	No	< 10s	+CME Error

29.14.1 Description

Enable/disables the storing of the last value of NMEA \$GSV messages, and gets the current messaging state. If the <state> parameter is enabled, the last value of NMEA \$GSV messages can be retrieved with the read command even when the GNSS is switched off.

The NMEA \$GSV messages are volatile.

29.14.2 Syntax

Type	Syntax	Response	Example
Set	AT+UGGSV=<state>	OK	AT+UGGSV=1



Type	Syntax	Response	Example
Read	AT+UGGSV?	+UGGSV: <state>,<\$GSV msg> OK	OK +UGGSV: 1,\$GPGSV,3,1,11,03,67,298,22,06,88,149,29,07,06,302,,08,05,332,25*73 \$GPGSV,3,2,11,09,02,334,25,14,02,141,,15,10,041,43,16,46,209,16*7D \$GPGSV,3,3,11,18,48,066,35,21,26,070,35,27,80,314,25*40 \$GLGSV,1,1,03,73,13,248,,74,23,298,20,75,09,348,19*51 OK +UGGSV: 0,NULL OK
Test	AT+UGGSV=?	+UGGSV: (list of supported <state>s) OK	+UGGSV: (0-1) OK

29.14.3 Defined values

Parameter	Type	Description
<state>	Number	<ul style="list-style-type: none"> 0 (factory-programmed value): to disable the NMEA \$GSV messages 1: to enable the NMEA \$GSV messages
<\$GSV msg>	String	NMEA \$GSV messages or "Not available" if the NMEA string is enabled, but this information has not been still sent to the user.

29.14.4 Notes

- Since the \$GSV message reports satellite information, the output of the different GNSS systems is not combined, but it is reported in sequence as in the example above with GPS and GLONASS.

29.15 Get recommended minimum GNSS data +UGRMC

+UGRMC						
Modules	LEON-G SARA-G340 SARA-G350 LISA-U1 LISA-U200-01S LISA-U200-02S LISA-U200-52S LISA-U200-62S LISA-U200-82S LISA-U230 LISA-U260 LISA-U270 SARA-U					
Attributes	Syntax	PIN required	Settings saved	Can be aborted	Response time	Error reference
	full	No	<i>NVM</i>	No	< 10s	+CME Error

29.15.1 Description

Enable/disable the storing of the last value of NMEA \$RMC messages, and gets the current messaging state. If the <state> parameter is enabled, the last value of NMEA \$RMC messages can be retrieved with the read command even when the GNSS is switched off.

The NMEA \$RMC messages are volatile.

29.15.2 Syntax

Type	Syntax	Response	Example
Set	AT+UGRMC=<state>	OK	AT+UGRMC=1 OK
Read	AT+UGRMC?	+UGRMC: <state>,<\$RMC msg> OK	+UGRMC: 1,\$GPRMC,142351.00,V,,,,,121213,,,N*7F OK +UGRMC: 0,NULL OK
Test	AT+UGRMC=?	+UGRMC: (list of supported <state>s) OK	+UGRMC: (0-1) OK



Type	Syntax	Response	Example
		OK	OK

29.15.3 Defined values

Parameter	Type	Description
<state>	Number	<ul style="list-style-type: none"> 0 (factory-programmed value): to disable the NMEA \$RMC messages 1: to enable the NMEA \$RMC messages
<\$RMC msg>	String	NMEA \$RMC messages or "Not available" if the NMEA string is enabled, but this information has not been still sent to the user.

29.16 Get course over ground and ground speed +UGVTG

+UGVTG						
Modules	LEON-G SARA-G340 SARA-G350					
	LISA-U1 LISA-U200-01S LISA-U200-02S LISA-U200-52S LISA-U200-62S LISA-U200-82S LISA-U230 LISA-U260 LISA-U270 SARA-U					
Attributes	Syntax	PIN required	Settings saved	Can be aborted	Response time	Error reference
	full	No	<i>NVM</i>	No	< 10s	+CME Error

29.16.1 Description

Enables/disables the storing of the last value of NMEA \$VTG messages, and gets know the current messaging state. If the <state> parameter is enabled, the last value of NMEA \$VTG messages can be retrieved with the read command even when the GNSS is switched off.

The NMEA \$VTG messages are volatile.

29.16.2 Syntax

Type	Syntax	Response	Example
Set	AT+UGVTG=<state>	OK	AT+UGVTG=1 OK
Read	AT+UGVTG?	+UGVTG: <state>,<\$VTG msg> OK	+UGVTG: 1,\$GPVTG,,,,,,,,,N*30 OK +UGVTG: 0,NULL OK
Test	AT+UGVTG=?	+UGVTG: (list of supported <state>s) OK	+UGVTG: (0-1) OK

29.16.3 Defined values

Parameter	Type	Description
<state>	Number	<ul style="list-style-type: none"> 0 (factory-programmed value): to disable the NMEA \$VTG messages 1: to enable the NMEA \$VTG messages
<\$VTG msg>	String	NMEA \$VTG messages or "Not available" if the NMEA string is enabled, but this information has not been still sent to the user.

29.17 Get satellite information +UGGSA

+UGGSA						
Modules	LEON-G SARA-G340 SARA-G350 LISA-U1 LISA-U200-01S LISA-U200-02S LISA-U200-52S LISA-U200-62S LISA-U200-82S LISA-U230 LISA-U260 LISA-U270 SARA-U					
Attributes	Syntax	PIN required	Settings saved	Can be aborted	Response time	Error reference
	full	No	<i>NVM</i>	No	< 10s	+CME Error

29.17.1 Description

Enables/disables the storing of the last value of NMEA \$GSA messages, and gets the current messaging state. If <state> parameter is enabled, the last value of NMEA \$GSA messages can be retrieved with the read command even when the GNSS is switched off.

The NMEA \$GSA messages are volatile.

29.17.2 Syntax

Type	Syntax	Response	Example
Set	AT+UGGSA=<state>	OK	AT+UGGSA=1 OK
Read	AT+UGGSA?	+UGGSA: <state>,<\$GSA msg> OK	+UGGSA: 1,\$GPGSA,A,1,,,,,,,,,,,,,99.99,99.99,99.99*30 OK +UGGSA: 0,NULL OK
Test	AT+UGGSA=?	+UGGSA: (list of supported <state>s) OK	+UGGSA: (0-1) OK

29.17.3 Defined values

Parameter	Type	Description
<state>	Number	<ul style="list-style-type: none"> 0 (factory-programmed value): to disable the NMEA \$GSA messages 1: to enable the NMEA \$GSA messages
<\$GSA msg>	String	NMEA \$GSA messages or "Not available" if the NMEA string is enabled, but this information has not been still sent to the user.

29.18 Ask for localization information +ULOC

+ULOC						
Modules	LEON-G SARA-G340 SARA-G350 LISA-U1 LISA-U200-01S LISA-U200-02S LISA-U200-52S LISA-U200-62S LISA-U200-82S LISA-U230 LISA-U260 LISA-U270 SARA-U					
Attributes	Syntax	PIN required	Settings saved	Can be aborted	Response time	Error reference
	full	No	No	No	< 10s	+CME Error

29.18.1 Description





Requests cellular module to provide the location data; the location can be determined using:

- GNSS receiver
- CellLocate® (location based on network cells data)
- Combination of both technologies (hybrid)

The result code indicates if sending the command request to the localization information process was successful or not. The URC is issued to provide the requested information via +ULOC set command.

The GNSS interface and CellLocate® can be used at the same time: if the GNSS sensor is reserved to another interface an error message is provided (error code "+CME ERROR: GPS busy" if +CME=2).

It is possible to configure the Hybrid Positioning through **+ULOC**GNSS and **+ULOCCELL** AT commands even if it is running: the parameters are stored in NVM and will be applied at the next +ULOC command.

-  If +ULOC command is sent while a previous +ULOC activity is still in progress the previous activity is aborted, the available position is immediately output and the next +ULOC request is served.
-  The data connection cannot be immediately dropped at the +ULOC timeout expiration. This could lead to a delay in the expected response time.
-  Depending on the aiding chosen, a data connection could be required; refer to **AT+UGPS** command description.
-  If no position is available (no GNSS coverage, no network information and no previous data available) then <lat> latitude and <long> longitude will be set to '0'.
-  If the previous position degraded by the elapsed time satisfies the desired accuracy then the sensor '0' is reported in the answer.

29.18.2 Syntax

Type	Syntax	Response	Example
Set	AT+ULOC=<mode>,<sensor>,<response_type>,<timeout>,<accuracy>[,<reserved>]	OK	AT+ULOC=2,3,0,120,1 OK
Read	AT+ULOC?	+ULOC: <mode>,<sensor>,<response_type>,<timeout>,<accuracy>,0 OK	+ULOC: 2,3,1,0,20,0 OK
Test	AT+ULOC=?	+ULOC: (list of supported <mode>s), (list of supported <sensor>s),(list of supported <response_type>s),(list of supported <timeout>s),(list of supported <accuracy>s),(0) OK	+ULOC: (0-2),(0-3),(0,1,255),(1-999),(0-999999),(0) OK
URC		If <response_type>=0: +UULOC: <date>,<time>,<lat>,<long>,<alt>,<uncertainty> If <response_type>=1: +UULOC: <date>,<time>,<lat>,<long>,<alt>,<uncertainty>,<speed>,<direction>,<vertical_acc>,<sensor_used>,<SV_used>,<antenna_status>,<jamming_status>	If <response_type>=0: +UULOC: 13/04/2011,09:54:51.000,45.6334520,13.0618620,49,1 If <response_type>=1: +UULOC: 25/09/2013,10:13:29.000,45.7140971,13.7409172,266,17,0,0,18,1,6,3,9

29.18.3 Defined values

Parameter	Type	Description
<mode>	Number	<ul style="list-style-type: none"> • 0: reserved • 1: reserved • 2: single shot position
<sensor>	Number	Sensor selection: it is possible to combine different sensors summing <sensor> values of the selected sensors <ul style="list-style-type: none"> • 0: use the last fix in the internal database and stop the GNSS receiver • 1: use the GNSS receiver for localization • 2: use CellLocate^(R) location information
<response_type>	Number	Type of response <ul style="list-style-type: none"> • 0: standard response • 1: detailed response • 255: reserved
<timeout>	Number	Timeout period in seconds (1 - 999)
<accuracy>	Number	Target accuracy in meters (1 - 999999)



Type	Syntax	Response	Example
		fix>,<staticHoldMode>,<SBAS>,<jamming>,<antenna>,<BBthreshold>,<CWthreshold>,<GNSS_system>,<reserved1>,<reserved2>	OK
Test	AT+ULOGNSS=?	+ULOGNSS: (list of supported <aiding>),(list of supported <psv_mode>),(list of supported <minSV>),(list of supported <minCNO>),(list of supported <ini_3d_fix>),(list of supported <staticHoldMode>),(list of supported <SBAS>),(list of supported <jamming>),(list of supported <antenna>),(list of supported <BBthreshold>),(list of supported <CWthreshold>),(list of supported <GNSS_system>),(0),(0) OK	+ULOGNSS: (0-15),(0-1),(3-32),(0-50),(0-1),(0-1000),(0-1),(0-1),(0-2),(0-15),(0-31),(1-127),(0),(0) OK

29.19.3 Defined values

Parameter	Type	Description
<aiding>	Number	GNSS aiding mode configuration; it is possible the combination of different aiding modes: to enable more aiding modes it is needed to sum the <mode> value of the interested aiding modes: <ul style="list-style-type: none"> • 1: local aiding (including RTC sharing) • 2: AssistNow Offline • 4: AssistNow Online • 8: AssistNow Autonomous All the modes (15) are enabled as a factory programmed setting.
<psv_mode>	Number	Power Save Mode (UBX-CFG-PM2): <ul style="list-style-type: none"> • 0 (factory-programmed value): disabled • 1: enabled
<minSV>	Number	<ul style="list-style-type: none"> • Minimum number of satellites for navigation (UBX-CFG-NAVX5). The range goes from 3 to 32. (factory-programmed value: 3)
<minCNO>	Number	<ul style="list-style-type: none"> • Minimum satellite signal level for navigation (UBX-CFG-NAVX5). The range goes from 0 to 50. (factory-programmed value: 7)
<ini_3d_fix>	Number	InitialFix must be 3D flag (UBX-CFG-NAVX5): <ul style="list-style-type: none"> • 0 (factory-programmed value): disabled • 1: enabled
<staticHoldMode>	Number	<ul style="list-style-type: none"> • Static Hold Mode (UBX-CFG-NAV5). The range goes from 0 to 1.000 cm/s. (factory-programmed value: 0)
<SBAS>	Number	SBAS configuration: <ul style="list-style-type: none"> • 0 (factory-programmed value): disabled • 1: enabled
<jamming>	Number	Jamming indicator (UBX-CFG-ITFM): <ul style="list-style-type: none"> • 0 (factory-programmed value): disabled • 1: enabled
<antenna>	Number	Antenna setting: <ul style="list-style-type: none"> • 0 (factory-programmed value): unknown • 1: passive • 2: active
<BBthreshold>	Number	Broadband jamming detection threshold (dB) (UBX-CFG-ITFM). The range goes from 0 to 15. (factory-programmed value: 0)
<CWthreshold>	Number	Continuous wave jamming detection threshold (dB) (UBX-CFG-ITFM). The range goes from 0 to 31. (factory-programmed value: 0)
<GNSS_systems>	Number	Supported GNSS types; the parameter is optional, the allowed values can be combined together: <ul style="list-style-type: none"> • 1 (factory-programmed value): GPS • 2: SBAS

Parameter	Type	Description
		<ul style="list-style-type: none"> • 4: Galileo • 8: BeiDou • 16: IMES • 32: QZSS • 64: GLONASS
<Reserved1>	Number	0 (reserved value)
<Reserved2>	Number	0 (reserved value)

29.19.4 Notes

- To enable SBAS system opportunely configure both <SBAS> and <GNSS_systems> parameters.
- If a parameter is omitted, the current set value is kept.
- For more details on parameter description see the corresponding u-blox-GNSS Receiver Description.

LEON-G / LISA-U / SARA-G300-00S / SARA-G310-00S / SARA-G340-00S / SARA-G350-00S / SARA-G350-00X

- The factory-programmed value of <GNSS_systems> is 0.

29.20 Configure cellular location sensor (CellLocate®) +ULOCCELL

+ULOCCELL						
Modules	LEON-G SARA-G340 SARA-G350 LISA-U1 LISA-U200-01S LISA-U200-02S LISA-U200-52S LISA-U200-62S LISA-U200-82S LISA-U230 LISA-U260 LISA-U270 SARA-U					
Attributes	Syntax	PIN required	Settings saved	Can be aborted	Response time	Error reference
	full	No	NVM	No	-	+CME Error

29.20.1 Description

Configures the Cellular location sensor (CellLocate®) used with the **+ULOC** command.



This command influences the amount of data exchanged with the server.

29.20.2 Syntax

Type	Syntax	Response	Example
Set	AT+ULOCCELL=<scan_mode>[,<reserved1>[,<reserved2>[,<reserved3>[,<reserved4>[,<reserved5>]]]]]	OK	AT+ULOCCELL=0 OK
Read	AT+ULOCCELL?	+ULOCCELL: <scan_mode>,<reserved1>,<reserved2>,<reserved3>,<reserved4>,<reserved5> OK	+ULOCCELL: 0,0,"", "", 0,0 OK
Test	AT+ULOCCELL=?	+ULOCCELL: (list of supported <scan_mode>s),(list of supported <reserved1>),(list of supported <reserved2>),(list of supported <reserved3>),(list of supported <reserved4>),(list of supported <reserved5>) OK	+ULOCCELL: (0-1),(0),"", "", (0),(0) OK

29.20.3 Defined values

Parameter	Type	Description
<scan_mode>	Number	Network scan mode <ul style="list-style-type: none"> • 0 (factory-programmed value): normal • 1: deep scan
<reserved1>	Number	RFU
<reserved2>	String	RFU



Parameter	Type	Description
<reserved3>	String	"" (reserved value)
<reserved4>	Number	0 (reserved value)
<reserved5>	Number	0 (reserved value)

29.20.4 Notes

- If the module is registered on 3G RAT, the <scan_mode> setting will be ignored and a deep scan will be performed.

30. DTMF

30.1 DTMF detection +UDTMFD

+UDTMFD						
Modules	LEON-G100-07S LEON-G100-08S SARA-G340 SARA-G350 LISA-U200-02S LISA-U200-52S LISA-U200-62S LISA-U200-82S LISA-U260-02S LISA-U270-02S LISA-U270-62S SARA-U					
Attributes	Syntax	PIN required	Settings saved	Can be aborted	Response time	Error reference
	full	No	No	No	-	+CME Error

30.1.1 Description

Enables/disables the DTMF detector and, independently for each specific AT terminal, the related URCs.

During a voice call, the DTMF detector recognizes the presence of DTMF tones in the RX voice channel. The tones are generated by remote party by e.g. digit press on a DTMF keypad.

The +UUDTMFD URC returns the recognized DTMF digits (set {0-9,#,*A,B,C,D}).

Once enabled, the DTMF detector is automatically started at the next call setup confirmation and stopped at call drop or when it is explicitly disabled.

If the DTMF detector is enabled, the In-Band Modem engine is reserved thus the eCall and other In-Band Modem applications are not available. For more details refer to [Chapter 31](#).

If the In-Band Modem engine is reserved by other In-Band Modem applications, the command immediately answers ERROR ("CME ERROR: 3" if CMEE=1 or "CME ERROR: operation not allowed" if CMEE=2).

URCs are issued at any DTMF digit detection, if the URCs have been enabled on the specific terminal.



QUICK START: AT+UDTMFD=1,2 (start in robust mode).



Issue the enabling command before the call set-up, otherwise the detector is not started.



For the complete description of the DTMF detection functionality see the corresponding module Audio Application Note.

30.1.2 Syntax

Type	Syntax	Response	Example
Set	AT+UDTMFD=<urc_en>[,<mode>[,<att_cfg>[,<threshold>[,<immunity>[,<max_int>]]]]]	OK	AT+UDTMFD=1,2 OK
Read	AT+UDTMFD?	+UDTMF: <urc_en>,<mode>,<att_cfg>,<threshold>,<immunity>,<max_int>,<att> OK	+UDTMFD: 1,2,4,100,14,2,4 OK
Test	AT+UDTMFD=?	+UDTMFD: (list of supported <urc_en>'s), (list of supported <mode>'s), (list of supported <att_cfg>'s), (list of supported <threshold>'s), (list of supported <immunity>'s), (list of supported <max_int>'s) OK	+UDTMFD: (0-1),(0-2),(0-15),(100-10000), (0-20), (1-255) OK
URC		+UUDTMFD: <DTMF>	+UUDTMFD: #
URC		+UUDTMFDE: <errid>	+UUDTMFD: 1

30.1.3 Defined values

Parameter	Type	Description
<urc_en>	Number	URC generation on the current terminal: <ul style="list-style-type: none"> • 0 (factory-programmed value): disabled • 1: enabled
<mode>	Number	DTMF detector configuration: <ul style="list-style-type: none"> • 0 (factory-programmed value): disabled • 1: enabled/restarted in normal mode • 2: enabled/restarted in robust mode
<att_cfg>	Number	Attenuation applied on the signal at decoder input to manage arithmetic operations. The range goes from 0 to 15, 6 dB attenuation each step. The factory-programmed value is 4 (24 dB attenuation).
<threshold>	Number	Numeric threshold to detect DTMF tones. The range goes from 100 to 10000. The factory-programmed value is 400.
<immunity>	Number	Speech immunity level. The higher the level, the higher the immunity to speech. The range goes from 0 (minimum immunity) to 20 (maximum immunity). The factory-programmed value is 14.
<max_int>	Number	Maximum interruption that a detected DTMF tone may have, such that it is still interpreted as a single digit. In multiples of 20 ms; the range goes from 1 to 255. The factory-programmed value is 2 (40 ms).
<att>	Number	Actual attenuation applied on the signal at decoder input. The starting value is <att_cfg>. If an arithmetic overflow occurs, it is automatically increased.
<DTMF>	Character	Detected DTMF digits; from the set {0-9,#,*,A-D}.
<errid>	Number	DTMF error code: <ul style="list-style-type: none"> • 1: arithmetic overflow

30.1.4 Notes

- The maximum interruption <max_int> also represents the expected minimum pause between two DTMF tones.
- The detector running in robust mode is less prone to false detections and more sensitive to speech distortions caused by e.g. low bit-rate AMR codec.
- The factory-programmed value of command parameters is set at each module start up.
- If the optional parameters are omitted the settings are left unchanged.

30.2 User setting for proactive DTMF tone generation +UDTMF

+UDTMF						
Modules	LISA-U120 LISA-U130 LISA-U200-01S LISA-U200-02S LISA-U200-52S LISA-U200-62S LISA-U200-82S LISA-U230 LISA-U260 LISA-U270 SARA-U					
Attributes	Syntax	PIN required	Settings saved	Can be aborted	Response time	Error reference
	full	No	<i>NVM</i>	No	-	<i>+CME Error</i>

30.2.1 Description

On a request from SIM Toolkit of proactive DTMF tone generation (SEND DTMF), <mode> parameter controls whether the request of DTMF tone generation is performed or it is not. The selected setting is stored in NVM and remains valid after the mobile device is switched off.

30.2.2 Syntax

Type	Syntax	Response	Example
Set	AT+UDTMF=<mode>	OK	AT+UDTMF=1 OK
Read	AT+UDTMF?	+UDTMF: <mode> OK	+UDTMF: 1 OK
Test	AT+UDTMF=?	+UDTMF: (list of supported <mode>s) OK	+UDTMF: (0-1) OK

30.2.3 Defined values

Parameter	Type	Description
<mode>	Number	Indicates the working mode in relation to DTMF tone generation via SIM-TK <ul style="list-style-type: none"> • 0: disable DTMF tone generation (The terminal response is "Proactive SIM session terminated by user") • 1 (factory-programmed value): enable DTMF tone generation (The terminal response is encoded according to the result)

30.3 Local DTMF tone generation configuration +UDCONF=31

+UDCONF=31						
Modules	LISA-U200-01S LISA-U200-02S LISA-U200-52S LISA-U200-62S LISA-U200-82S LISA-U230 LISA-U260 LISA-U270 SARA-U					
Attributes	Syntax	PIN required	Settings saved	Can be aborted	Response time	Error reference
	full	No	No	No	-	-

30.3.1 Description

Configures the local DTMF tone generation.



The local DTMF tone generation applies to user-required tones only, i.e. started via AT+VTS and AT+UVTS commands and not by SIM Toolkit application (aka proactive DTMF tones).

30.3.2 Syntax

Type	Syntax	Response	Example
Set	AT+UDCONF=31,<local_tone_generation>	OK	AT+UDCONF=31,1 OK
Read	AT+UDCONF=31	+UDCONF: 31,<local_tone_generation> OK	AT+UDCONF=31 +UDCONF: 31,1 OK

30.3.3 Defined values

Parameter	Type	Description
<local_tone_generation>	Number	Local DTMF tone generation enable / disable: <ul style="list-style-type: none"> • 0 (factory-programmed value): local DTMF tone generation disabled • 1: local DTMF tone generation enabled This setting is volatile

31. eCall

31.1 Introduction

eCall (emergency Call) specification [63] standardizes the transfer of a set of 140 bytes of data, called Minimum Set of Data (MSD) during an emergency voice call to a Public Safety Answering Point (PSAP). According to 3GPP specifications, the eCall In-band Modem (eIM) of the In-Vehicle System (IVS) immediately transmits the MSD after the call setup; the MSD is received by the eIM of the PSAP.

In the call setup message the IVS Network Access Device (NAD) shall set the "Service Category" information (IE) according to ETSI TS 122 101 [71]. This eCall "flag" enables a serving "Mobile Switching Centre" (MSC) that supports this functionality, to differentiate between speech only Teleservice 12 emergency calls and eCalls. Additionally the MSC may also be able to discriminate between Manually Initiated eCalls and Automatically Initiated eCalls.

When the IVS eIM is in activated state, during the call, the eIM receiver starts monitoring link messages from PSAP eIM by analyzing the audio stream on the downlink speech channel. Once the link with PSAP eIM is established, the IVS eIM enters the so-called data-mode: the IVS microphone and loudspeaker are muted and the eIM starts the MSD transfer. After the data transfer is completed, either successfully or with errors, the IVS switches from data-mode into voice-mode: the microphone and the loudspeaker are un-muted and the voice call between IVS and PSAP proceeds normally. The IVS eIM enters idle-mode and monitors new incoming messages from PSAP eIM.

The eCall standard introduces specific mobility management procedures to be implemented in the IVS NAD. In particular, the IVS NAD is configured at boot time by a valid, eCall-enabled SIM/USIM to work either in "eCall only" mode or in normal mode.

More precisely, the eCall feature is a Release 10 feature that can be enabled on the USIM by NMO. If a USIM is eCall enabled (e.g. service n. 89 is active), the FDN and SDN services may also be used to define how the MS will work, i.e. either as an eCall only device or as eCall-enabled device.

In particular, if the FDN service is enabled and activated, the MS acts as eCall-only device and the FDN phonebook contains 2 entries which are the test and reconfiguration numbers. Only these two numbers can be dialed in addition to the Manually Initiated and Automatically Initiated emergency calls.

If the MS acts as an eCall-enabled device, the SDN service is activated and the SDN phonebook contains the test and reconfiguration numbers in its last 2 entries.

If a MS is equipped with a SIM which is not eCall enabled, it can be set to eCall-only and eCall-enabled device via the `+UECALLSTAT` command. In this case, and if the FDN or SDN phonebooks are not properly configured, test and reconfiguration numbers may be specified via the `+UDCONF=90` command.

31.1.1 About eCall AT commands

The 3GPP eCall feature is implemented and controlled by AT interface through a set of dedicated AT commands:

- `AT+UECALLSTAT`: used to check the eCall SIM configuration / force a configuration (eCall only mode)
- `AT+UECALLTYPE`: used to configure the eCall flag or Test eCall
- `AT+CECALL`: used to trigger a Manually Initiated eCall, a Automatically Initiated eCall, a Test or a Reconfiguration call
- `AT+UECALLDATA`: used to
 - o activate the eIM, passing the MSD data
 - o update the MSD during the emergency call
 - o enable the eIM feature, reserving In-band modem audio resources for eCall
 - o enable unsolicited indications
- `AT+UECALLVOICE`: used to
 - o configure the microphone / speaker switching handling
 - o control and monitor microphone and speaker switching



- +UECALLDATA: eIM status indications
- +UECALLVOICE: microphone/loudspeaker status indications

31.2 eIM sends and receives data +UECALLDATA

+UECALLDATA						
Modules	LEON-G100-07S LEON-G100-08S SARA-G340 SARA-G350 LISA-U200-02S LISA-U200-52S LISA-U200-62S LISA-U200-82S LISA-U260-02S LISA-U270-02S LISA-U270-62S SARA-U270-00S					
Attributes	Syntax	PIN required	Settings saved	Can be aborted	Response time	Error reference
	full	No	No	No	-	+CME Error

31.2.1 Description

Activates the IVS eIM for a single emergency call (eCall session) and provides the IVS eIM with the MSD to transfer. If the activation command is issued when there is no call ongoing, the eIM is armed, i.e. the MSD is prepared for transmission. The eIM is then automatically activated as soon as the call setup indication is received. The eIM can be armed/activated once per eCall session. Further activations immediately provide an error message.

The eIM can be activated in PULL or PUSH mode. In PUSH mode, the IVS eIM sends the INITIATION signal to request to PSAP to pull the MSD, i.e. it asks the PSAP to send the "SEND MSD" signal.

The command can also be used for terminating the eIM: the last +UECALLDATA activation command is aborted.

The command serves also to update the IVS eIM with new MSD data. The update command can be issued at any time during the eCall session and may or may not force an eIM reset.



The terms "SEND MSD", "INITIATION" and "application layer ACK" (AL-ACK), mentioned in BS EN 160 62:211 [72], correspond to the START signal sent by PSAP to IVS, the START signal sent by IVS to PSAP and the higher-layer ACK (HL-ACK), mentioned in 3GPP TS 26.267 [73].

31.2.2 Syntax

Type	Syntax	Response	Example
Set	AT+UECALLDATA=<op>[,<param1>[,<data>]]	OK	AT+UECALLDATA=1,0,"4D5344" OK
Read	AT+UECALLDATA?	+UECALLDATA: <state>,<urc_state> OK	+UECALLDATA: 0,1 OK
Test	AT+UECALLDATA=?	+UECALLDATA: (range of supported <op>),(range of supported <param1> OK	+UECALLDATA: (0-4),(0-2) OK
URC		+UUECALLDATA: <urc_id>[,<data>]	+UUECALLDATA: 7,"0B"

31.2.3 Defined values

Parameter	Type	Description
<op>	Number	Operation to perform: <ul style="list-style-type: none"> • 0: abort. The In-Band Modem is terminated • 1: arm/activate eCall In-Band Modem (eIM) • 2: update MSD • 3: enable/disable URCS • 4: enable/disable the eCall feature
<param1>	Number	The meaning depends on the <op> parameter. If <op> is 1 <param1> specifies the PULL/PUSH mode:



Parameter	Type	Description
		<ul style="list-style-type: none"> 0: PULL mode 1: PUSH mode If <op> is 2 <param1> specifies the update mode: <ul style="list-style-type: none"> 0: update in idle only 1: immediate update / force eIM reset If <op> is 3 <ul style="list-style-type: none"> 0: disable URCs (factory-programmed value) 1: enable URCs except for URCs with id 11-19 2: enable all URCs If <op> is 4 <ul style="list-style-type: none"> 0: disable the feature (factory-programmed setting) 1: enable the feature. URCs are automatically enabled (same as +UECALLDATA=3,1)
<state>	Number	eIM current state: <ul style="list-style-type: none"> 0: off 1: armed/active
<urc_state>	Number	URCs current state: <ul style="list-style-type: none"> 0: disabled 1: enabled without IVS events (without URCs with id 11-19) 2: enabled
<urc_id>	Number	Specifies the event type: <ul style="list-style-type: none"> 0: MSD correctly sent, HL-ACK check bits received and recorded. <data>: four information bits received through HL-ACKs, returned within single byte hex data (e.g.: +UECALLDATA: 0,"OB" -> 0xB: 4 information bits) 1: eIM lost synchronization with PSAP 2: Reserved 3: Reserved 4: Reserved 5: eIM is terminated: audio error 6: eIM is terminated: fatal error 7: eIM is terminated: call drop 8: generic eIM error 11: IVSEVENT_SENDINGSTART: eIM starts sending the INITIATION signal (only in PUSH mode). Also indicates that the call set-up is completed 12: IVSEVENT_SENDINGMSD: "SEND MSD" signal received, eIM starts sending MSD 13: IVSEVENT_RESTARTMSD: "SEND MSD" signal received too often, assume PSAP sync failure 14: IVSEVENT_CONTROLSYNC: IVS eIM is synchronizing with PSAP eIM 15: IVSEVENT_CONTROLLOCK: IVS eIM is synched with PSAP eIM 16: IVSEVENT_LLACKRECEIVED: 2. link-layer ACK received and recorded 17: IVSEVENT_HLACKRECEIVED: 2. higher-layer ACK received and recorded 18: IVSEVENT_IDLEPOSTRESET: IVS eIM is idling after a full reset. Reset is done after the sync loss, due to e.g. end of PSAP transmission 19: IVSEVENT_IDLEPOSTSTART: IVS eIM transmitter is idling after the transmission of the INITIATION signal (PUSH mode) 20: MSD update request received. MSD update deferred since the IVS is currently transmitting 21: MSD update done. The IVS transmitter is ready to send the new MSD at next PULL request 22: MSD update request cannot be processed
<data>	String	MSD to be sent. Each byte is coded with two characters in hex notation. It shall not exceed 280 characters (140 bytes)

31.3 IVS eIM voice control +UECALLVOICE

+UECALLVOICE						
Modules	LEON-G100-07S LEON-G100-08S SARA-G340 SARA-G350 LISA-U200-02S LISA-U200-52S LISA-U200-62S LISA-U200-82S LISA-U260-02S LISA-U270-02S LISA-U270-62S SARA-U270-00S					
Attributes	Syntax	PIN required	Settings saved	Can be aborted	Response time	Error reference
	full	No	No	No	-	+CME Error

31.3.1 Description

Configures the control and/or controls the TX and RX voice path connections to voice resources (microphone and loudspeaker respectively) and to eIM transmitter (eIM receiver is not affected by the control). The command serves to handle the switching³ of the voice resources according to HLAP specifications [72].

With this command, it is possible to implement the voice control following several strategies:

- Internal handling: eIM handles voice path connections. Refer to [Chapter 31.3.4](#) for details
- External handling: the application processor exclusively handles voice path connections. The internal handling must be disabled before the eCall session is started
- Mixed handling: eIM and application processor handle voice path connections



The internal handling can be enabled / disabled during the eCall.

[Table 29](#) summarizes the impact of the voice resource switching on the voice path connections:

Voice resource	Status	Description
Microphone	Un-muted	The microphone is connected to the TX voice path. The eIM transmitter is disconnected from the TX voice path
	Muted	The microphone is disconnected from the TX voice path. The eIM transmitter is connected to the TX voice path
Loudspeaker	Un-muted	Both the loudspeaker and the eIM receiver are connected to the RX voice path
	Muted	The loudspeaker is disconnected from the RX voice path. The eIM transmitter is connected to the RX voice path

Table 29: Voice path connections as function of the microphone/loudspeaker status

The microphone and eIM transmitter are exclusively connected to the TX voice path, while the eIM receiver is always connected to the RX voice path (always listening to PSAP). Of course, eIM can be connected to the voice paths only if armed/activated (refer to [Chapter 31.2](#), +UECALLDATA command).



The microphone switches should internally be controlled since they affect the eIM functionality (if the microphone is un-muted, the eIM cannot transmit data).



Loudspeaker switches do not affect the eIM functionality.

The command groups three operations:

1. Internal voice control configuration

When internal voice control is enabled (factory-programmed value), the eIM internally performs some microphone and loudspeaker switching. In particular:

- The microphone is muted as soon as the eIM transmitter starts a transmission
- The microphone is un-muted as soon as the eIM transmitter completes a transmission
- The microphone is un-muted according to T5 - IVS wait for SEND MSD period in eCall HLAP specifications [72], Annex A, Table of Timings
- The loudspeaker is muted as soon as the call set-up is confirmed (i.e. at the indication that the PSAP has answered the call)

³ A switch performs a muting of un-muted voice resource or vice versa



- The loudspeaker is un-muted according to T5 - IVS wait for SEND MSD period in eCall HLAP specifications [72], Annex A, Table of Timings
- The loudspeaker is muted as soon as the PULL request from PSAP eIM is detected
- The loudspeaker is un-muted as soon as the link with PSAP is lost

For more details refer to [Chapter 31.3.4](#).

Deactivating the internal handling, the application shall take the full switching control. In the mixed approach, the voice resource (e.g. microphone) is configured with internal control (suggested configuration for microphone).

2. Voice resource control/switching

This command mutes/un-mutes the microphone or loudspeaker (regardless of voice control configuration). It also provides the voice resource muted/un-muted state.

The command provides an error message if the eIM is not activated or if the voice resource is already in the state instructed by the command.

3. URC enabling - indications of a voice resource switch

This command enables/disables URCs providing loudspeaker/microphone switching notifications.

31.3.2 Syntax

Type	Syntax	Response	Example	
Set	Generic syntax: AT+UECALLVOICE=<cmd_id>,<param1>,<param2>	OK		
	Internal voice control configuration: AT+UECALLVOICE=1,<res_id>,<on_off_ctrl>	OK	AT+UECALLVOICE=1,0,1 OK	
	Voice resource control/switching: AT+UECALLVOICE=2,<res_id>,<mute_unmute>	OK	AT+UECALLVOICE=2,0,1 OK	
	URC enabling: AT+UECALLVOICE=3,<res_id>,<urc_state>	OK	AT+UECALLVOICE=3,1,0 OK	
	Get	Generic syntax: AT+UECALLVOICE=<cmd_id>,<param1>	+UECALLVOICE: <cmd_id>,<param1>,<param2> OK	
	Internal voice control configuration: AT+UECALLVOICE=1,<res_id>	+UECALLVOICE: 1,<res_id>,<on_off_ctrl> OK	AT+UECALLVOICE=1,0 +UECALLVOICE: 1,0,1 OK	
Voice resource control/switching: AT+UECALLVOICE=2,<res_id>	+UECALLVOICE: 2,<res_id>,<res_state> OK	AT+UECALLVOICE=2,0 +UECALLVOICE: 2,0,1 OK		
URC enabling: AT+UECALLVOICE=3,<res_id>	+UECALLVOICE: 3,<res_id>,<urc_state> OK	AT+UECALLVOICE=3,0 +UECALLVOICE: 3,0,1 OK		
Test	AT+UECALLVOICE=?	+UECALLVOICE: (range of supported <cmd_id>s) OK	+UECALLVOICE: (0-3) OK	
URC		+UUECALLVOICE: <res_id>,<res_state>	+UUECALLVOICE: 1,1	

31.3.3 Defined values

Parameter	Type	Description
<cmd_id>	Number	Type of operation: <ul style="list-style-type: none"> • 0: Reserved for future use





Parameter	Type	Description
		<ul style="list-style-type: none"> 1: Enable/Disable voice resource internal control (by eIM) 2: Mute/Un-mute voice resource 3: Enable/disable/query URC generation for specific voice resource
<res_id>	Number	Voice resource identifier: <ul style="list-style-type: none"> 0: microphone 1: loudspeaker
<on_off_ctrl>	Number	Flag to enable or disable the eIM internal control of voice resource: <ul style="list-style-type: none"> 0: disabled 1: enabled (factory-programmed value) If left empty, then the flag status is queried.
<mute_unmute>	Number	Flag to mute or un-mute the voice resource. Allowed values: <ul style="list-style-type: none"> 0: mute 1: unmute If left empty, then the voice resource status <res_state> is queried.
<urc_state>	Number	Flag to enable or disable URCs on voice resource status: <ul style="list-style-type: none"> 0: disabled (factory-programmed value) (do not receive URCs when resource status changes) 1: enabled (receive URCs when resource status changes) If left empty, then the <urc_state > is queried.
<res_state>	Number	Voice resource state. Allowed values: <ul style="list-style-type: none"> 0: muted (microphone / loudspeaker disconnected) 1: un-muted (factory-programmed value) (microphone / loudspeaker connected)

31.3.4 Voice control internal handling



With voice control internal handling, eIM performs the microphone and/or loudspeaker switches. Microphone and loudspeaker switches or loudspeaker un-muting timer start-up generally occur at IVS URC events (refer to [Chapter 31.2.3](#)), according to the [Table 30](#):

Event / IVS event	Microphone mute	Microphone un-mute	Loudspeaker mute	Loudspeaker un-mute
Call setup notification			Immediate	Start T5 timer, un-mute at expiration
IVSEVENT_SENDINGSTART	Immediate			
IVSEVENT_SENDINGMSD	Immediate		Immediate	
IVSEVENT_LLACKRECEIVED		Immediate		
IVSEVENT_HLACKRECEIVED		Immediate		Start TH timer, un-mute at expiration. timer value is 1.2 s in fast modulation mode, 2.4 s in robust modulation mode
IVSEVENT_IDLEPOSTRESET		Immediate		Immediate
IVSEVENT_IDLEPOSTSTART		Immediate		
eIM transmitter interrupts the INITIATION signal since sync has been detected (internal event)		Immediate		

Table 30: eIM handling of Microphone/loudspeaker switches. Call setup notification event is externally available as +UCALLSTAT=1,0 URC

-  Microphone switches are performed within high-priority 3GPP eIM execution thread.
-  When eIM transmitter enters idle mode, the microphone is always un-muted.
-  When eIM performs a full reset, both microphone and loudspeaker are immediately un-muted.
-  The purpose of loudspeaker un-muting TH timer is to keep the loudspeaker muted for the duration of 3 HLACKs that are received after the 2nd HLACK.



-  T5 is the 2 s timer "T5 - IVS wait for SEND MSD period" specified in eCall HLAB specifications [72], Annex A, Table of Timings.
-  eIM transmitter always transmits the INITIATION signal for at most 2 s, thus microphone un-muting on T5 timer expiration shall not be necessary. The beginning of the transmission of the INITIATION signal is notified by the SENDINGSTART event; if no synchronization is achieved, the transmitter enters idle mode and the IDLEPOSTSTART event occurs.
-  When the LLACKRECEIVED event occurs, the eIM stops the transmission. The microphone is immediately un-muted, thus microphone un-muting on T6 timer expiration should not be necessary.

31.3.5 Implementation of eCall HLAB timing requirements

The internal handling complies with the eCall HLAB timing requirements regarding the voice switching as specified by the document "eSafety - eCall high level application requirements (HLAB)" [72] (Table A.1 - Table of timings, Annex A) for the following timings:

T3:	IVS INITIATION signal duration, the signal lasts 2 s.
T5:	IVS wait for SEND MSD period.

Additionally, the application processor must handle the following timings:

T6:	IVS wait for AL-ACK period; 5 s timer must be started at LLACKRECEIVED event
T7:	IVS MSD maximum transmission time; 20 s timer must be started at SENDINGMSD event.

31.4 eCall configuration +UECALLSTAT

+UECALLSTAT						
Modules	LEON-G100-07S LEON-G100-08S SARA-G340 SARA-G350 LISA-U120 LISA-U130 LISA-U200-02S LISA-U200-52S LISA-U200-62S LISA-U200-82S LISA-U260-02S LISA-U270-02S LISA-U270-62S SARA-U270-00S					
Attributes	Syntax	PIN required	Settings saved	Can be aborted	Response time	Error reference
	full	Yes	No	No	-	+CME Error

31.4.1 Description

-  LISA-U120 / LISA-U130
The command is supported with partial functionality and a limited range for testing purposes only.

According to EN 16062:2011 [72], eCall configuration of an eCall-enabled IVS must automatically be read from a valid SIM/USIM that supports the provision of the eCall service (i.e. valid eCall USIM, according to 3GPP TS 31.102 [19]).

The eCall-enabled SIM can be configured only for eCall (referred in EN 16062:2011 [72] as "eCall only"), or a combination of eCall and commercial service provision (referred in 3GPP TS 26.267 [73] as "eCall without registration restrictions"). In particular, an IVS NAD configured in eCall only mode boots up with network registration restriction, i.e. the IVS NAD does not perform the standard mobility management procedures.

-  In case IVS NAD is configured as eCall only, the MS class is implicitly set to GSM only, i.e. no GPRS service is available by default.

This command serves to:

- Read the eCall configuration from the SIM
- Force the module with a not valid eCall SIM configuration to eCall only or eCall without registration restriction (for testing purposes)

Forcing a valid eCall SIM to a different eCall state, the module returns the final result code +CME ERROR: 3 (Operation not allowed).

Enabling and disabling eCall only mode with registration restriction (also by restoring SIM settings) can only be performed if the module is unregistered.

 If the module does not support the +CECALL AT command, the state switches can only be performed if the module is not registered on the network.

31.4.2 Syntax

Type	Syntax	Response	Example
Set	AT+UECALLSTAT=<cmd>	OK	
Read	AT+UECALLSTAT?	+UECALLSTAT: <state> OK	+UECALLSTAT: 1 OK
Test	AT+UECALLSTAT=?	+UECALLSTAT: (list of supported <cmd>s) OK	+UECALLSTAT: (0-3) OK

31.4.3 Defined values

Parameter	Type	Description
<state>	Number	<ul style="list-style-type: none"> 0: not valid eCall SIM present (not eCall-enabled) 1: eCall only with registration restriction 2: eCall without registration restriction
<cmd>	Number	<ul style="list-style-type: none"> 0: Force to not valid eCall SIM (not eCall-enabled) 1: Force eCall only with registration restriction 2: Force eCall without registration restriction 3: Restore SIM/USIM settings (read from SIM)

31.5 eCall and InBM test configuration +UDCONF=90

+UDCONF=90						
Modules	LEON-G100-07S LEON-G100-08S SARA-U270-00S					
Attributes	Syntax	PIN required	Settings saved	Can be aborted	Response time	Error reference
	partial	No	NVM	No	-	+CME Error

31.5.1 Description

Configures some eCall parameters. It is available in eCall Release 3 and sets the following functionalities:

- eCall test number
- eCall reconfiguration number
- Factory-programmed T3242 timer duration
- Factory-programmed T3243 timer duration

 eCall settings cannot be stored to NVM to prevent fake SIM usage.

31.5.2 Syntax

Type	Syntax	Response	Example
Set	eCall generic syntax AT+UDCONF=90,<ecall_param_type>,...	OK	
	eCall test number AT+UDCONF=90,1,<ToN>,<number>	OK	AT+UDCONF=90,1,129,"02338456" OK
	eCall reconfiguration number AT+UDCONF=90,2,<ToN>,<number>	OK	AT+UDCONF=90,2,129,"1234" OK
	eCall T3242 timer duration AT+UDCONF=90,11,<timer_duration>	OK	AT+UDCONF=90,11,43200 OK
	eCall T3243 timer duration AT+UDCONF=90,12,<timer_duration>	OK	AT+UDCONF=90,12,43200 OK
Read	eCall generic syntax AT+UDCONF=90,<ecall_param_type>,...	AT+UDCONF=90,<ecall_param_type>,...	

Type	Syntax	Response	Example
	AT+UDCONF=90,<ecall_param_type>	OK	
	eCall test number	+UDCONF: 90,1,<ToN>,<number>	AT+UDCONF=90,1
	AT+UDCONF=90,1	OK	+UDCONF: 90,1,129,"1234" OK
	eCall reconfiguration number	+UDCONF: 90,2,<ToN>,<number>	AT+UDCONF=90,2
	AT+UDCONF=90,2	OK	+UDCONF: 90,2,129,"1234" OK
	eCall T3242 timer duration	+UDCONF: 90,11,<timer_duration>	AT+UDCONF=90,11
	AT+UDCONF=90,11	OK	+UDCONF: 90,11,43200 OK
	eCall T3243 timer duration	+UDCONF: 90,12,<timer_duration>	AT+UDCONF=90,12
	AT+UDCONF=90,12	OK	+UDCONF: 90,12,43200 OK

31.5.3 Defined values

Parameter	Type	Description
<ecall_param_type>	Number	Class of eCall/IBM parameter (values lower than 10 corresponds to the USIM settings, NAD settings otherwise). Allowed values: <ul style="list-style-type: none"> • 1: eCall test number • 2: eCall reconfiguration number • 11: T3242 timer duration • 12: T3243 timer duration
<ToN>	Number	Specifies the type of address octet <ToN>: <ul style="list-style-type: none"> • 145: international number, i.e. when dialling string starts with '+' • 129: national coded number, otherwise
<number>	String	eCall Test or Reconfiguration number. <ul style="list-style-type: none"> • Number in string format <number>. The default value is "".
<timer_duration>	Number	Specifies the 32-bit timer duration defined in seconds. The value 0 is not supported. The default value is 43200 (12 hours)

31.5.4 Notes

- If it is not specified with the set command, Test and Reconfiguration numbers are retrieved from FDN or SDN entries, if the USIM is a valid eCall enabled USIM
- If it is specified with the set command, <number> overwrites the USIM eCall Test or Reconfiguration number retrieved from FDN or SDN entries, if any
- If <ToN>= 145, the number specified with <number> shall start with "+"

SARA-G

- The test command is not supported.

LEON-G

- The test command is not supported.

31.6 eCall type +UECALLTYPE

+UECALLTYPE						
Modules	LEON-G100-07S LEON-G100-08S SARA-G340 SARA-G350 LISA-U120 LISA-U130 LISA-U200-02S LISA-U200-52S LISA-U200-62S LISA-U200-82S LISA-U260-02S LISA-U270-02S LISA-U270-62S SARA-U270-00S					
Attributes	Syntax	PIN required	Settings saved	Can be aborted	Response time	Error reference
	full	No	No	No	-	+CME Error

31.6.1 Description

Sets the emergency call service category, i.e. the "eCall flag". According to ETSI TS 122 101 [71] and 3GPP TS 24.008 [12], an eCall can be either Manually Initiated (MIeC, Manually Initiated eCall) or Automatically Initiated (AIeC, Automatically Initiated eCall), which is configured through specific eCall flag bits. If none of such bits is set, the Mobile Switching Centre (MSC) supporting eCall functionality will operate a speech-only TS12 emergency call.

The "eCall flag" is included in the call set-up message whenever the emergency number is dialed (with "ATD112;").

This command also configures the system to perform Test or Reconfiguration eCalls, according to 3GPP TS 51.0 10-1 [74], Section 26.9.6a. When performing "ATD112;", the Test or Reconfiguration numbers read from the eCall Test USIM/SIM will be respectively dialed.

The default eCall type (<type>=0) cannot be changed if the USIM is not eCall enabled or if the eCall status has not been forced to eCall enabled via AT+UECALLSTAT command.

The combination of +UECALLTYPE set command and ATD112; triggers an eCall to the network, and functionally complies with the 3GPP eCall initiation command +CECALL.

If the eCall is disabled (refer to section [Chapter 31.4](#), +UECALLSTAT command), the set command returns the error result code +CME ERROR: 3 (Operation not allowed).



If the module supports +CECALL AT command, the +UCALLTYPE is set to zero after the eCall of the selected type has been released. This reduces the possibility that eCalls are originated accidentally.



If the module supports +CECALL AT command, the set command with <type> 3 or 4 returns the error result code +CME ERROR: 1806 if test or reconfiguration numbers are not available or not properly encoded.

31.6.2 Syntax

Type	Syntax	Response	Example
Set	AT+UECALLTYPE=<type_of_eCall>	OK	
Read	AT+UECALLTYPE?	+UECALLTYPE: <type_of_eCall> OK	+UECALLTYPE: 1 OK
Test	AT+UECALLTYPE=?	+UECALLTYPE: (list of supported <type_ of_eCall>s) OK	+UECALLTYPE: (0-4) OK

31.6.3 Defined values

Parameter	Type	Description
<type_of_eCall>	Number	<ul style="list-style-type: none"> 0: speech only TS12 (factory-programmed value) 1: MIeC: Emergency Service Category Value (octet 3) Bit 6=1 2 :AIeC: Emergency Service Category Value (octet 3) Bit 7=1 3: Test eCall: use eCall Test number 4: Reconfiguration eCall: use eCall Reconfiguration number

31.6.4 Notes

LISA-U120 / LISA-U130

- The command is supported with partial functionality and a limited range for testing purposes only.

31.7 Initiate eCall +CECALL

+CECALL						
Modules	LEON-G					
	SARA-U270-00S					
Attributes	Syntax	PIN required	Settings saved	Can be aborted	Response time	Error reference
	full	No	No	No	-	+CME Error

31.7.1 Description

According to ETSI TS 127 007 [82], the set command triggers an eCall to the network. Based on the configuration selected, it can be used to either trigger a test call, a reconfiguration call, a manually initiated eCall or an automatically initiated eCall.

The read command returns the type of eCall currently in progress, if any. If an eCall is not in progress, the read command returns the error result code +CME ERROR: 3 (Operation not allowed).

The test command returns the supported values and ranges.

The command behavior depends on whether a valid eCall USIM is used or not.

- Valid eCall USIM: the command fails when the test/reconfiguration calls are started and there is no valid test/reconfiguration number on the eCall USIM. The +UDCONF command can overwrite the test/reconfiguration numbers values read from the USIM (see AT+UDCONF, eCall/InBM test configuration). The +UDCONF values are volatile: they are lost at next power on or reset.
- Not Valid eCall USIM: starting an eCall via +CECALL AT command with a not eCall USIM is possible, provided that the eCall status has been enabled via +UECALLSTAT command. In addition, the test and reconfiguration numbers should be provided through +UDCONF command. Otherwise, +CECALL AT command fails if a test/reconfiguration call is started.

31.7.2 Syntax

Type	Syntax	Response	Example
Set	AT+CECALL=<type_of_eCall>	OK	AT+CECALL=1 OK
Read	AT+CECALL?	+CECALL: <type_of_eCall> OK	+CECALL: 1 OK
Test	AT+CECALL=?	+CECALL: (list of supported <type_of_eCall>s) OK	+CECALL: (0-3) OK

31.7.3 Defined values

Parameter	Type	Description
<type_of_eCall>	Number	<ul style="list-style-type: none"> 0: test call 1: reconfiguration call 2: manually initiated eCall (MIeC) 3: automatically initiated eCall (AIeC)

31.7.4 Notes

- The set command is functionally equivalent to the combination of +UECALLTYPE and ATD112.
- The set command with <type> 0 or 1 returns the error result code +CME ERROR: 1806 if test or reconfiguration numbers are not available or not properly encoded.

32. SAP

32.1 Introduction

The SIM Access Profile (SAP) allows communication between a device electrically connected to a SIM module (SAP Server) and a device using that SIM (SAP Client). The SAP details are specified in the Bluetooth Specification "SIM Access Profile - Interoperability Specification" [67].

u-blox modules support SAP client functionalities using a serial connection to transport the SAP messages defined in the SAP Specification: in SAP Client mode, the u-blox cellular module uses a remote SIM, which is physically present in the SAP Server, to perform all SIM-related operations; the local SIM card, directly connected to the module (U)SIM interface, is not accessed.

At power on SAP is disabled in the u-blox cellular module i.e. the local SIM card (directly connected to the module (U)SIM interface) is used. It is possible to enter SAP client mode and switch to using a remote SIM via AT commands. At any time, either the local or remote SIM is exclusively used; this is transparent to AT clients: for example when interrogating the IMSI with +CIMI, the result always refers to the "current" SIM: the local SIM's IMSI if SAP is not active or the remote SIM's IMSI if SAP Client mode is active.

URCs are provided to inform the user about the state of both local and remote SIM when SAP mode is active:

- The +UUSAPREMOTE URC reports information related to the "remote" SIM
- The +UUSAPLOCAL URC reports information related to the local SIM card directly connected to the module (U)SIM interface

For more details refer to [Chapter 32.3](#).

[Table 31](#) shows which indications are to be expected in case of local or remote SIM events (hot removal/insertion):

Event	SAP client not active	SAP client active
Local SIM removal/insertion	+CIEV: 12,<value>	+UUSAPLOCAL: <sim_present>
Remote SIM removal/insertion	-	+UUSAPREMOTE: <sim_present>

Table 31: SIM indications and SAP

For further details about SAP implementation, refer to the LISA-U series System Integration Manual [49].

 u-blox cellular modules do not act as SAP server.

32.2 SAP mode activation +USAPMODE

+USAPMODE						
Modules	LISA-U200-01S LISA-U200-02S LISA-U200-52S LISA-U200-62S LISA-U200-82S LISA-U230 LISA-U260 LISA-U270 SARA-U					
Attributes	Syntax	PIN required	Settings saved	Can be aborted	Response time	Error reference
	full	No	No	No	-	+CME Error

32.2.1 Description

Changes the SAP connection mode:

- Local SIM: the local SIM is used, SAP is not active
- SAP Client: the module acts as a SAP Client, a remote SIM is used

It is not possible to change the SAP mode during a call or with an active PDP context.

When entering SAP Client mode, SAP communication takes place in a separate dedicated serial channel, according to the <format> indication (currently only binary mode is supported).

The command can only be invoked from a USB or a MUX AT channel.

When invoked from a USB channel, the dedicated serial channel for SAP is USB channel.

When invoked from a MUX channel, the dedicated serial channel for SAP is MUX channel.

The communication between SAP client and server follows the "Connect" procedure (as specified by SAP specification [67]), which uses the <beacon> parameter.

The actual switch between local and remote SIM takes place only when a connection has been established between SAP Client and the SAP Server. The value of the SAP mode returned by the read command does not change as long as the connection is active.

The SAP Client mode terminates when:

- The SAP connection fails (communication lost, unrecoverable error, unsuccessful connect negotiation)
- The SAP server commands a disconnection
- The AT command to move back to local SIM mode is received

SAP client mode activation may result in an error code in case of SAP connection cannot be established. Result codes are listed in the Errors section (refer to [Appendix A.7](#)).

32.2.2 Syntax

Type	Syntax	Response	Example
Set	AT+USAPMODE=<sap_mode>[,<format>[,<beacon>]]	OK	AT+USAPMODE=0 OK AT+USAPMODE=1,0,6 OK
Read	AT+USAPMODE?	+USAPMODE: <sap_mode> OK	+USAPMODE: 0 OK
Test	AT+USAPMODE=?	+USAPMODE: (list of supported <sap_mode>),(list of supported <format>),(list of supported <beacon>) OK	+USAPMODE: (0,1),0,(0-65535) OK

32.2.3 Defined values

Parameter	Type	Description
<sap_mode>	Number	Specifies the SAP mode. Possible values: <ul style="list-style-type: none"> • 0 (default value): Internal SIM (SAP disabled) • 1: SAP Client
<format>	Number	Specifies the SAP communication format. This parameter can be set only if <sap_mode> is 1 or 2. Possible values: <ul style="list-style-type: none"> • 0 (default value): Binary; SAP messages are exchanged transparently in binary format
<beacon>	Number	Period in seconds between consecutive CONNECT_REQ messages during the "Connect" procedure. This parameter can be set only if <sap_mode> is 1. 0 means one shot sending. Default value is 6 s. Possible range is [0-65535].

32.3 SAP mode indications +USAPIND

+USAPIND						
Modules	LISA-U200-01S LISA-U200-02S LISA-U200-52S LISA-U200-62S LISA-U200-82S LISA-U230 LISA-U260 LISA-U270 SARA-U					
Attributes	Syntax	PIN required	Settings saved	Can be aborted	Response time	Error reference
	full	No	No	No	-	+CME Error

32.3.1 Description

Enables or disables the URC generation for the SAP mode status change indication (+UUSAPMODE) and the detection of a local SIM (+UUSAPLOCAL) when SAP client is active.



At power up, the URCs are disabled.

32.3.2 Syntax

Type	Syntax	Response	Example
Set	AT+USAPIND=<ind_mode>	OK	AT+USAPIND=0 OK
Read	AT+USAPIND?	+USAPIND: <ind_mode> OK	+USAPIND: 0 OK
Test	AT+USAPIND=?	+USAPIND: (list of supported <ind_mode>) OK	+USAPIND: (0,1) OK
URC		+UUSAPMODE: <sap_mode>	+UUSAPMODE: 0
URC		+UUSAPLOCAL: <sim_present>	+UUSAPLOCAL: 0

32.3.3 Defined values

Parameter	Type	Description
<ind_mode>	Number	Specifies whether SAP-related URCs are enabled or disabled. Possible values: <ul style="list-style-type: none">• 0 (default value): Disabled• 1: Enabled
<sap_mode>	Number	Specifies which SAP mode is currently used. Possible values: <ul style="list-style-type: none">• 0 (default value): Internal SIM (SAP disabled)• 1: SAP Client• 2: SAP Server
<sim_present>	Number	Specifies the status of locally attached SIM. Possible values: <ul style="list-style-type: none">• 0: Local SIM is present• 1: Local SIM is not present

A Appendix: Error codes

A.1 Internet suite error classes

The following table lists all allowed error classes that can be provided by the <error_class> parameter for each AT error command (+UFTPER, +UHTTPER, +USMTPER) for FTP, HTTP and SMTP.

<error_class>	Meaning	<error_codes>	Resulting from the following commands
0	OK, no error occurred		All
1	FTP Protocol error class	See the Appendix A.1.1	+UFTPC, +UFTP, +UFTPER
2	SMTP Protocol error class	See the Appendix A.1.3	+USMTP, +USMTPM, +USMTPC, +USMTPER
3	HTTP Protocol error class	See the Appendix A.1.2	+UHTTP, +UHTTPC, +UHTTPER
4	Flash File System error class	See the Appendix A.1.4	+UFTPC, +UFTPER, +UHTTPC, +UHTTPER
5	DNS error class		+UFTPC, +UFTPER, +UHTTPC, +UHTTPER, +USMTPC, +USMTPER
6	Socket error class	BSD error codes standard	All
7	Dynamic Memory error	0	All
8	Wrong FTP API usage (e.g. missing/null parameters)	See the Appendix A.1.1	+UFTPC, +UFTP, +UFTPER
9	Wrong SMTP API usage (e.g. missing/null parameters)	See the Appendix A.1.3	+USMTP, +USMTPM, +USMTPC, +USMTPER
10	Wrong HTTP API usage (e.g. missing/null parameters)	See the Appendix A.1.2	+UHTTP, +UHTTPC, +UHTTPER
11	Syntax error in high layer Protocol (wrong/missing/corrupted data)		+UFTPC, +UFTPER, +UHTTPC, +UHTTPER, +USMTPC, +USMTPER
12	Unspecified error	0	All

A.1.1 FTP class error codes

The following table lists the available values of <error_code> parameter of the last FTP operation provided through +UFTPER AT command if <error_class>=1 or 8.

<err>	Meaning	Resulting from the following commands
0	No error	+UFTPC, +UFTP
1	User missing	+UFTPC
2	Password missing	+UFTPC
3	Account missing	+UFTPC
4	Server missing	+UFTPC
5	Directory name missing	+UFTPC
6	File name missing	+UFTPC
7	Null parameter	+UFTPC, +UFTP
8	Unknown FTP command	+UFTPC, +UFTP
9	Unknown file action	+UFTPC
10	Wrong FTP state	+UFTPC
11	Wrong parameter	+UFTPC, +UFTP
12	PSD or CSD connection not established	+UFTPC
13	No memory available for allocation	+UFTPC, +UFTP
14	Reserved internal code	+UFTPC, +UFTP
15	Length of given web server (address or hostname) too long or too short	+UFTPC, +UFTP
16	Hostname of given web server invalid	+UFTPC, +UFTP
17	Address of given web server is invalid	+UFTPC, +UFTP
18	Username too long or too short	+UFTPC, +UFTP
19	Password too long or too short	+UFTPC, +UFTP
20	Account too long or too short	+UFTPC, +UFTP



<err>	Meaning	Resulting from the following commands
21	Operation not allowed because FTP client is busy	+UFTPC
22	Not possible to connect to FTP server	+UFTPC
23	Error occurred in FTP request	+UFTPC
24	Reserved internal code	+UFTPC, +UFTP
25	FFS filename pointer is null or its length is 0	+UFTPC
26-30	Reserved internal code	+UFTPC, +UFTP
31	Timeout elapsed while performing requested operation	+UFTPC
32	Internal processing error	+UFTPC, +UFTP
33	Not logged in	+UFTPC
34	Login incorrect	+UFTPC
35	File unavailable (not found or no access)	+UFTPC
36	File not ready	+UFTPC
37	Filename not allowed	+UFTPC
38	Folder not found	+UFTPC
39	Folder no access	+UFTPC
40	Operation aborted by user	+UFTPC
41	Permission denied	+UFTPC
42	Cannot open FTP data channel	+UFTPC
43	Socket invalid parameter	+UFTPC
44	Invalid socket	+UFTPC
45	No socket available	+UFTPC
46	Cannot create socket	+UFTPC
47	Cannot bind socket to network interface	+UFTPC
48	Cannot resolve hostname	+UFTPC
49	Cannot connect socket	+UFTPC
50	Cannot get socket name	+UFTPC
51	Cannot bind socket to port	+UFTPC
52	Socket cannot listen	+UFTPC
53	Socket cannot accept	+UFTPC
54	Socket would block	+UFTPC
55	Socket cannot write	+UFTPC
56	Socket cannot read	+UFTPC
57	Reserved internal code	+UFTPC
58	No socket data to send	+UFTPC
59	Socket cannot get available data	+UFTPC
60	No socket data to read	+UFTPC
61	Socket no response code found	+UFTPC
62	Socket not connected	+UFTPC
63	Cannot set secure socket	+UFTPC
64	Socket cannot decode password	+UFTPC
65	Socket cannot get size	+UFTPC
66	FFS Invalid parameter	+UFTPC
67	FFS invalid handle	+UFTPC
68	FFS cannot open file	+UFTPC
69	FFS cannot seek file	+UFTPC
70	FFS cannot get file size	+UFTPC
71	FFS cannot read	+UFTPC
226	Closing data connection; requested file action successful (for example, file transfer or file abort)	+UFTPC
250	Requested file action okay, completed	+UFTPC
350	Requested file action pending further information	+UFTPC
421	Service not available, closing control connection.	+UFTPC
	User limit reached	
	Not authorized to make the connection	
	Maximum connections reached	

<err>	Meaning	Resulting from the following commands
	Maximum connections exceeded	
425	Cannot open data connection	+UFTPC
426	Connection closed; transfer aborted. The command opens a data connection to perform an action, but that action is cancelled, and the data connection is closed	+UFTPC
450	Requested file action not taken. File unavailable (e.g. file busy)	+UFTPC
451	Requested action aborted: local error in processing	+UFTPC
452	Requested action not taken. Insufficient storage space in system	+UFTPC
500	Syntax error, command unrecognized, command line too long	+UFTPC
501	Syntax error in parameters or arguments	+UFTPC
502	Command not implemented	+UFTPC
503	Bad sequence of commands	+UFTPC
504	Command not implemented for that parameter	+UFTPC
530	User not logged in	+UFTPC
532	Need account for storing files	+UFTPC
550	Requested action not taken. File unavailable, not found, not accessible	+UFTPC
552	Requested file action aborted. Exceeded storage allocation	+UFTPC
553	Requested action not taken. Filename not allowed	+UFTPC

 For all the errors not listed in the table see the RFC 959 [75].

A.1.2 HTTP class error codes

The following table lists the available values of <error_code> parameter of the last HTTP operation provided through +UHTTPE AT command if <error_class>=3 or 10.

<err>	Meaning	Resulting from the following commands
0	No error	+UHTTP, +UHTTPC
1	Invalid profile ID	+UHTTP, +UHTTPC
2	Invalid input	+UHTTP, +UHTTPC
3	Server hostname too long	+UHTTP
4	Invalid server hostname	+UHTTP
5	Invalid server IP address	+UHTTP
6	Invalid authorization method	+UHTTP
7	Server missing	+UHTTPC
8	Username length exceeded	+UHTTP
9	Password length exceeded	+UHTTP
10	Internal error	+UHTTP, +UHTTPC
11	Server connection error	+UHTTPC
12	Error occurred in HTTP request	+UHTTPC
13	Internal error	+UHTTP, +UHTTPC
14	Internal error	+UHTTP, +UHTTPC
15	Invalid POST data size	+UHTTPC
16	Empty FFS file name	+UHTTPC
17	Invalid FFS file length	+UHTTPC
18	Invalid content-type specified	+UHTTP, +UHTTPC
19	Internal error	+UHTTP, +UHTTPC
20	Internal error	+UHTTP, +UHTTPC
21	Internal error	+UHTTP, +UHTTPC
22	PSD or CSD connection not established	+UHTTPC
23	Server or proxy hostname lookup failed	+UHTTPC
24	User authentication failed on server	+UHTTPC
25	User authentication failed on proxy	+UHTTPC
26	Connection timed out	+UHTTPC
27	Request prepare timeout expired	+UHTTPC
28	Response receive timeout expired	+UHTTPC

<err>	Meaning	Resulting from the following commands
29	Request send timeout expired	+UHTTTPC
30	HTTP operation in progress	+UHTTTPC
31	Invalid HTTP parameter TCP port not in range (1-65535)	+UHTTTPC
32	Invalid HTTP parameter secure	+UHTTTPC
33	Invalid HTTP parameter authentication username	+UHTTTPC
34	Invalid HTTP parameter authentication password	+UHTTTPC
35	Invalid HTTP parameter output filename	+UHTTTPC
36	Invalid HTTP parameter output filename length (0-47) characters.	+UHTTTPC
37	Invalid HTTP parameter server path	+UHTTTPC
38	Invalid HTTP parameter server path length (1-128)	+UHTTTPC
39	Invalid HTTP parameter content filename length (0-47) characters	+UHTTTPC
40	Invalid custom content type string	+UHTTTPC
41	Output file open error	+UHTTTPC
42	Output file close error	+UHTTTPC
43	Output file write error	+UHTTTPC
44	Connection lost	+UHTTTPC
45	Operation not allowed in current state	+UHTTTPC
46	Internal error	+UHTTTPC
47	Internal error	+UHTTTPC
48	Internal error	+UHTTTPC
49	Internal error	+UHTTTPC
50	Internal error	+UHTTTPC
51	Internal error	+UHTTTPC
52	Internal error	+UHTTTPC
53	Internal error	+UHTTTPC
54	Internal error	+UHTTTPC
55	Internal error	+UHTTTPC
56	Internal error	+UHTTTPC
57	Internal error	+UHTTTPC
58	Internal error	+UHTTTPC
59	Internal error	+UHTTTPC
60	Internal error	+UHTTTPC
61	Internal error	+UHTTTPC
62	Internal error	+UHTTTPC
63	Internal error	+UHTTTPC
64	Internal error	+UHTTTPC
65	Internal error	+UHTTTPC
66	Internal error	+UHTTTPC
67	Internal error	+UHTTTPC
68	Internal error	+UHTTTPC
69	Internal error	+UHTTTPC
70	Internal error	+UHTTTPC
71	Internal error	+UHTTTPC
72	Internal error	+UHTTTPC
73	Secure socket connect error	+UHTTTPC

A.1.3 SMTP class error codes

The following table lists the available values of <error_code> parameter of the last SMTP operation provided through +USMTPER AT command if <error_class>=2 or 9.

<err>	Meaning	Resulting from the following commands
0	No error	+USMTP, +USMTPM, +USMTPC
1	Server missing	+USMTPC
2	Sender address missing	+USMTPC
3	Receiver address missing	+USMTPC



<err>	Meaning	Resulting from the following commands
4	Maximum number of receivers exceeded	+USMTPC
5	Maximum address length exceeded	+USMTPC
6	Internal error	+USMTPM, +USMTPC
7	Maximum subject length exceeded	+USMTPC
8	Maximum number of attachments exceeded	+USMTPC
9	Wrong SMTP state	+USMTPM, +USMTPC
10	Wrong parameter	+USMTPC
11	Internal error	+USMTP, +USMTPM, +USMTPC
12	PSD or CSD connection not established	+USMTPC

A.1.4 File system class error codes

The following table lists the available values of <error_code> parameter of the last FTP, HTTP or SMTP operation provided through *+UFTPER*, *+UHHTPER* and *+USMTPER* AT commands if the <error_class> is 4 "Flash File System error class".

<err>	Meaning	Resulting from the following commands
2	Operation performed with success	+UHHTPC, +UFTPC, +USMTPC
3	Initialization in progress	+UHHTPC, +UFTPC, +USMTPC
4	File already opened	+UHHTPC, +UFTPC, +USMTPC
5	File not opened	+UHHTPC, +UFTPC, +USMTPC
6	File not found	+UHHTPC, +UFTPC, +USMTPC
7	File already created	+UHHTPC, +UFTPC, +USMTPC
8	Illegal id	+UHHTPC, +UFTPC, +USMTPC
9	Illegal file handle	+UHHTPC, +UFTPC, +USMTPC
10	Illegal type	+UHHTPC, +UFTPC, +USMTPC
11	Illegal mode	+UHHTPC, +UFTPC, +USMTPC
12	File range error	+UHHTPC, +UFTPC, +USMTPC
13	The operation is not possible	+UHHTPC, +UFTPC, +USMTPC
14	Write error	+UHHTPC, +UFTPC, +USMTPC
15	User id error	+UHHTPC, +UFTPC, +USMTPC
16	Internal fatal error	+UHHTPC, +UFTPC, +USMTPC
17	Memory resource error	+UHHTPC, +UFTPC, +USMTPC
18	Maximum number of files exceeded	+UHHTPC, +UFTPC, +USMTPC
19	Memory not available	+UHHTPC, +UFTPC, +USMTPC
20	Invalid filename	+UHHTPC, +UFTPC, +USMTPC
21	Streaming not enabled	+UHHTPC, +UFTPC, +USMTPC
22	Operation not allowed on static file	+UHHTPC, +UFTPC, +USMTPC
23	Memory table inconsistency	+UHHTPC, +UFTPC, +USMTPC
24	Not a factory default file	+UHHTPC, +UFTPC, +USMTPC
25	Requested memory temporary not available	+UHHTPC, +UFTPC, +USMTPC
26	Operation not allowed for a directory	+UHHTPC, +UFTPC, +USMTPC
27	Space in the directory space not available	+UHHTPC, +UFTPC, +USMTPC
28	Too many streaming files opened	+UHHTPC, +UFTPC, +USMTPC
29	Requested dynamic memory temporary not available	+UHHTPC, +UFTPC, +USMTPC
30	The user provided a NULL parameter instead of a suitable buffer	+UHHTPC, +UFTPC, +USMTPC

A.2 Ping error codes

The following table lists the available values of <error_code> parameter of the last PING operation provided through +UUPINGER unsolicited indication (for more details see the *AT+UPING* command description).

<err>	Meaning	Resulting from the following commands
0	Success (no error)	+UPING
1 - 6	Internal error (ping level)	+UPING
7	Empty remote host	+UPING
8	Cannot resolve host	+UPING

<err>	Meaning	Resulting from the following commands
9	Unsupported IP version (RFU)	+UPING
10	Invalid IPv4 address	+UPING
11	Invalid IPv6 address (RFU)	+UPING
12	Remote host too long	+UPING
13	Invalid payload size	+UPING
14	Invalid TTL value	+UPING
15	Invalid timeout value	+UPING
16	Invalid retries number	+UPING
17	PSD or CSD connection not established	+UPING
100 - 105	Internal error (ICMP level)	+UPING
106	Error creating socket for ICMP	+UPING
107	Error settings socket options for ICMP	+UPING
108	Cannot end ICMP packet	+UPING
109	Read for ICMP packet failed	+UPING
110	Received unexpected ICMP packet	+UPING
111-115	Internal error (socket level)	+UPING

A.3 Internal TCP/UDP/IP stack class error codes



The following table lists all allowed error classes that can be provided by the internal TCP/UDP/IP stack through **+USOER** and **+USOCTL** (with param_id=1) AT commands.

<err>	Meaning	Resulting from the following commands
0	No error	+USOCR, +USOSO, +USOGO, +USOCO, +USOWR, +USOST, +USORD, +USORF, +USOLI
2	ENOENT - No such resource (internal error)	+USOCR, +USOSO, +USOGO, +USOCO, +USOWR, +USOST, +USORD, +USORF, +USOLI
4	EINTR - Interrupted system call (internal error)	+USOCR, +USOSO, +USOGO, +USOCO, +USOWR, +USOST, +USORD, +USORF, +USOLI
5	EIO - I/O error (internal error)	+USOCR, +USOSO, +USOGO, +USOCO, +USOWR, +USOST, +USORD, +USORF, +USOLI
9	EBADF - Bad file descriptor (internal error)	+USOCR, +USOSO, +USOGO, +USOCO, +USOWR, +USOST, +USORD, +USORF, +USOLI
10	ECHILD - No child processes (internal error)	+USOCR, +USOSO, +USOGO, +USOCO, +USOWR, +USOST, +USORD, +USORF, +USOLI
11	EWOULDBLOCK - Current operation would block, try again	+USOWR
12	ENOMEM - Out of memory (internal error)	+USOCR, +USOSO, +USOGO, +USOCO, +USOWR, +USOST, +USORD, +USORF, +USOLI
14	EFAULT - Bad address (internal error)	+USOCR, +USOSO, +USOGO, +USOCO, +USOWR, +USOST, +USORD, +USORF, +USOLI
22	EINVAL - Invalid argument	+USOCR, +USOSO, +USOGO, +USOCO, +USOWR, +USOST, +USORD, +USORF, +USOLI
32	EPIPE - Broken pipe (internal error)	+USOCR, +USOSO, +USOGO, +USOCO, +USOWR, +USOST, +USORD, +USORF, +USOLI
38	ENOSYS - Function not implemented	+USOSO, +USOGO
92	ENOPROTOPT - Protocol not available	+USOCR
98	EADDRINUSE - Address already in use	+USOLI
103	ECONNABORTED - Software caused connection abort	+USOCR, +USOSO, +USOGO, +USOCO, +USOWR, +USOST, +USORD, +USORF, +USOLI
104	ECONNRESET - Connection reset by peer	+USOCR, +USOSO, +USOGO, +USOCO, +USOWR, +USOST, +USORD, +USORF, +USOLI
105	ENOBUFS - No buffer space available	+USOCR, +USOSO, +USOGO, +USOCO, +USOWR, +USOST, +USORD, +USORF, +USOLI
107	ENOTCONN - Transport endpoint is not connected	+USOCR, +USOSO, +USOGO, +USOCO, +USOWR, +USOST, +USORD, +USORF, +USOLI
108	ESHUTDOWN - Cannot send after transport endpoint shutdown	+USOCR, +USOSO, +USOGO, +USOCO, +USOWR, +USOST, +USORD, +USORF, +USOLI
110	ETIMEDOUT - Connection timed out	+USOCO, +USOST, +USORD, +USORF
113	EHOSTUNREACH - No route to host	+USOCO, +USOWR, +USOST, +USORD, +USORF

<err>	Meaning	Resulting from the following commands
115	EINPROGRESS - Operation now in progress	+USOCR, +USOSO, +USOGO, +USOCO, +USOWR, +USOST, +USORD, +USORF, +USOLI
160	ENSRNODATA - DNS server returned answer with no data	+UDNSRN
161	ENSRFORMERR - DNS server claims query was misformatted	+UDNSRN
162	ENSRSERVFAIL - DNS server returned general failure	+UDNSRN
163	ENSRNOTFOUND - Domain name not found	+UDNSRN
164	ENSRNOTIMP - DNS server does not implement requested operation	+UDNSRN
165	ENSRREFUSED - DNS server refused query	+UDNSRN
166	ENSRBADQUERY - Misformatted DNS query	+UDNSRN
167	ENSRBADNAME - Misformatted domain name	+UDNSRN
168	ENSRBADFAMILY - Unsupported address family	+UDNSRN
169	ENSRBADRESP - Misformatted DNS reply	+UDNSRN
170	ENSRCONNREFUSED - Could not contact DNS servers	+UDNSRN
171	ENSRTIMEOUT - Timeout while contacting DNS servers	+UDNSRN
172	ENSRF - End of file	+UDNSRN
173	ENSRFILE - Error reading file	+UDNSRN
174	ENSRNOMEM - Out of memory	+UDNSRN
175	ENSRDESTRUCTION - Application terminated lookup	+UDNSRN
176	ENSRQUERYDOMAINTOOLONG - Domain name is too long	+UDNSRN
177	ENSRNAMELOOP - Domain name is too long	+UDNSRN

A.4 Dynamic DNS unsolicited indication codes

<code>	Meaning	Resulting from the following commands
0	Success	+UUDYNDNS
1	Data connection lost while performing update	+UUDYNDNS
2	Cannot update dynamic DNS because a private IP address has been assigned to the module	+UUDYNDNS
3	Connection to dynamic DNS server failed	+UUDYNDNS
4	Error occurred sending data to dynamic DNS server	+UUDYNDNS
5	Error occurred reading response from dynamic DNS server	+UUDYNDNS
6	Timeout while waiting response from dynamic DNS server	+UUDYNDNS
7	Dynamic DNS server closed connection unexpectedly	+UUDYNDNS
8	Unexpected response from dynamic DNS server	+UUDYNDNS
9	Dynamic DNS response seems to be incomplete	+UUDYNDNS
10	Update has been delayed in order to respect DNS update protocol timing specification	+UUDYNDNS
40	Dynamic DNS protocol specific: good (TZO code 200)	+UUDYNDNS
41	Dynamic DNS protocol specific: nochg (TZO code 304)	+UUDYNDNS
42	Dynamic DNS protocol specific: notfqdn	+UUDYNDNS
43	Dynamic DNS protocol specific: nohost	+UUDYNDNS
44	Dynamic DNS protocol specific: numhost	+UUDYNDNS
45	Dynamic DNS protocol specific: badauth (TZO code 401)	+UUDYNDNS
46	Dynamic DNS protocol specific: badagent (TZO code 405)	+UUDYNDNS
47	Dynamic DNS protocol specific: !donator	+UUDYNDNS
48	Dynamic DNS protocol specific: abuse	+UUDYNDNS
49	Dynamic DNS protocol specific: dnserr	+UUDYNDNS
50	Dynamic DNS protocol specific: 911	+UUDYNDNS
51	Dynamic DNS protocol specific: badsys	+UUDYNDNS
52	Dynamic DNS protocol specific: !yours	+UUDYNDNS
53	Dynamic DNS protocol specific: TZO code 403	+UUDYNDNS
54	Dynamic DNS protocol specific: TZO code 407	+UUDYNDNS
55	Dynamic DNS protocol specific: TZO code 414	+UUDYNDNS
56	Dynamic DNS protocol specific: TZO code 415	+UUDYNDNS
57	Dynamic DNS protocol specific: TZO code 480	+UUDYNDNS
100-108	Internal errors	+UUDYNDNS

-  The meaning of dynamic DNS protocol specific codes depends on the provider used; see the provider documentation.
-  Errors 45, 46, 53, 54 and 56 trigger a client self deactivation when the provider is TZO.com.
-  Errors 42, 43, 44, 46, 48, 51 and 52 trigger a client self deactivation when the selected provider is DynDNS.org or DynDNS.it or No-IP.org or DynamicDNS.org.

A.5 IP change notification error codes

<code>	Meaning	Resulting from the following commands
0	The IP CN feature was enabled from a previous working session and is active	+UUIPCHGN
10	Internal PSD data connection is not active	+UUIPCHGN
11	Invalid IP address assigned to module (e.g. empty string)	+UUIPCHGN
12	IMEI could not be retrieved	+UUIPCHGN
13	IMSI could not be retrieved	+UUIPCHGN
14	Error preparing HTTP GET request for IP CN	+UUIPCHGN
15	Error creating socket for HTTP connection	+UUIPCHGN
16	Error connecting to remote HTTP server	+UUIPCHGN
17	Error sending HTTP GET request to HTTP server	+UUIPCHGN
18	Error receiving or parsing HTTP GET response from HTTP server	+UUIPCHGN

A.6 FOAT error result codes

See [+UFWUPD](#) command description.

Response	Description
ERROR1	The operation has been interrupted and the actual FW is unchanged; the module drops out from Firmware Update Mode
ERROR2	The operation has been interrupted during FW updating; the actual firmware is corrupted and the module remains in Firmware Update Mode
ERROR3	The signature check fails
ERROR4	The module has received unexpected EOT because not all expected bytes have been received
ERROR5	The boot does not support the selected baudrate
ERROR6	Invalid AT command sent during boot
FLS header decoding failed	An error occurs during decoding of file header
Buffer Data Overrun	The buffers are not filled at least with a 1029 packet: data comes too slowly
Timeout	The command must be re-sent: no data is coming

A.7 Mobile Termination error result codes +CME ERROR

<err>	Meaning	Resulting from the following commands
0	Phone failure	undetermined
1	No connection to phone	
2	Phone-adaptor link reserved	
3	Operation not allowed	See the footnote ⁴
4	Operation not supported	See the footnote ⁴ , +CMER and +UCIND
5	PH-SIM PIN required	See the footnote ⁴
10	SIM not inserted	See the footnote ⁴

⁴ +CACM, +CALA, +CALD, +CALM, +CAMP, +CAOC, +CBST, +CCFC, +CCLK, +CCUG, +CCWA, +CCWE, +CEER, +CFUN, +CGACT, +CGATT, +CGCLASS, +CGDATA, +CGDCONT, +CGEREP, +CGMI, +CGMM, +CGMR, +CGPADDR, +CGQMIN, +CGQREQ, +CGREG, +CGSMS, +CGSN, +CHLD, +CHUP, +CIMI, +CIND, +CLAC, +CLCC, +CLCK, +CLIP, +CLIR, +CLVL, +CMEE, +CMOD, +CMUT, +CMUX, +CNUM, +COLP, +COPS, +CPAS, +CPBF, +CPBR, +CPBS, +CPBW, +CPIN, +CPOL, +CPUC, +CPWD, +CR, +CRC, +CREG, +CRLP, +CRSL, +CRSM, +CSCS, +CSGT, +CSNS, +CSQ, +CSSN, +CSTA, +CTFR, +CTZR, +CTZU



<err>	Meaning	Resulting from the following commands
11	SIM PIN required	See the footnote ⁴
12	SIM PUK required	See the footnote ⁴
13	SIM failure	See the footnote ⁴
14	SIM busy	See the footnote ⁴
15	SIM wrong	See the footnote ⁴
16	Incorrect password	+CLCK, +CPWD, +CPIN, ATD*...#...
17	SIM PIN2 required	
18	SIM PUK2 required	
20	Memory full	+CPBW, +CPOL
21	Invalid index	+CPBR, +CPBW
22	Not found	+COPS, +CHLD, +CGATT, ATD*...#...
23	Memory failure	+CSAS, +CRES, +CSGT
24	Text string too long	+CPBW
25	Invalid characters in text string	ATD*...#...
26	Dial string too long	ATD, +CPBW
27	Invalid characters in dial string	ATD, +CPBW, ...
30	No network service	ATD, +COPS, +CLIR, ...
31	Network timeout	ATD
32	Network not allowed - emergency calls only	
40	Network personalisation PIN required	
41	Network personalisation PUK required	
42	Network subset personalisation PIN required	
43	Network subset personalisation PUK required	
44	Service provider personalisation PIN required	
45	Service provider personalisation PUK required	
46	Corporate personalisation PIN required	
47	Corporate personalisation PUK required	
50	Incorrect parameters	+CIND
100	Unknown	
103	Illegal MS	+CGATT, +COPS
106	Illegal ME	+CGATT, +COPS
107	GPRS services not allowed	+CGATT
108	GPRS and non GPRS services not allowed	+CGATT
111	PLMN not allowed	+CGATT, +COPS
112	Location area not allowed	+CGATT, +COPS
113	Roaming not allowed in this location area	+CGATT, +COPS
132	Service option not supported	+CGACT or other non-GPRS commands
133	Requested service option not subscribed	+CGACT or other non-GPRS commands
134	Service option temporarily out of order	+CGACT or other non-GPRS commands
135	NS-api already used	
148	Unspecified GPRS error	all GPRS related commands
149	PDP authentication failure	+CGACT
150	Invalid mobile class	all GPRS related commands
156	User Busy	+UI2CO, +UI2CW, +UI2CREGR, +UI2CR, +UI2CC
254	Invalid error mapping	
255	Internal error	
701	Incorrect security code	
702	Max attempts reached	
1001	Unassigned (unallocated) number	
1003	No route to destination	
1006	Channel unacceptable	
1008	Operator determined barring	
1016	Normal call clearing	
1017	User busy	
1018	No user responding	



<err>	Meaning	Resulting from the following commands
1019	User alerting, no answer	
1021	Call rejected	
1022	Number changed	
1026	Non selected user clearing	
1027	Destination out of order	
1028	Invalid number format (incomplete number)	
1029	Facility rejected	
1030	Response to STATUS ENQUIRY	
1031	Normal, unspecified	
1034	No circuit/channel available	
1038	Network out of order	+COPS, +CGATT
1041	Temporary failure	+COPS, +CGATT
1042	Switching equipment congestion	+COPS, +CGATT
1043	Access information discarded	
1044	requested circuit/channel not available	
1047	Resources unavailable, unspecified	
1049	Quality of service unavailable	
1050	Requested facility not subscribed	
1055	Incoming calls barred within the CUG	
1057	Bearer capability not authorized	
1058	Bearer capability not presently available	
1063	Service or option not available, unspecified	
1065	Bearer service not implemented	
1068	ACM equal to or greater than ACMmax	
1069	Requested facility not implemented	
1070	Only restricted digital information bearer capability is available	
1079	Service or option not implemented, unspecified	
1081	Invalid transaction identifier value	
1087	User not member of CUG	
1088	Incompatible destination	
1091	Invalid transit network selection	
1095	Semantically incorrect message	
1096	Invalid mandatory information	
1097	Message type non-existent or not implemented	
1098	Message type not compatible with protocol state	
1099	Information element non-existent or not implemented	
1100	Conditional IE error	
1101	Message not compatible with protocol state	
1102	Recovery on timer expiry	
1111	Protocol error, unspecified	
1127	Interworking, unspecified	
1279	Number not allowed	
1283	CCBS possible	
1500	Wrong GPIO identifier	+UGPIOC, +UGPIOR, +UGPIOW
1501	Set GPIO default error	+UGPIOC
1502	Select GPIO mode error	+UGPIOC
1503	Read GPIO error	+UGPIOR
1504	Write GPIO error	+UGPIOW
1505	GPIO busy	+UGPIOC
1520	Wrong ADC identifier	+UADC
1521	Read ADC error	+UADC
1530	IPv4 only allowed	+UDCONF=66
1540	Wrong ringer identifier	+URNG
1548	PDP activation rejected	+UPSDA
1549	unknown PDP address or PDP type	+UPSDA



<err>	Meaning	Resulting from the following commands
1550	GPRS generic operation error	+UPSD, +UPSDA
1551	GPRS invalid APN	+UPSDA
1552	GPRS authentication failure	+UPSDA
1553	GPRS QoS parameters inconsistent	+UPSD
1554	GPRS network failure	+UPSDA, +CGATT, +CGACT
1555	GPRS context busy	+UPSD, +UPSDA
1556	CSD generic operation error	+UCSD, +UCSDA, +UCSND
1557	CSD undefined profile	+UCSDA
1558	CSD context busy	+UCSD, +UCSDA
1600	FFS error	
1612	File not found	+UPLAYFILE, +UDELFILE
1613	Cannot open file	+UDWNFILE, +ULSTFILE
1620	Buffer full	+USOWR, +USOST
1621	FFS initializing	+UDWNFILE
1622	FFS already open file	+UDWNFILE
1623	FFS not open file	+UDWNFILE
1624	FFS file not found	+UDWNFILE
1625	FFS file already created	+UDWNFILE
1626	FFS illegal id	+UDWNFILE
1627	FFS illegal file handle	+UDWNFILE
1628	FFS illegal type	+UDWNFILE
1629	FFS illegal mode	+UDWNFILE
1630	FFS file range	+UDWNFILE, +URDBLOCK
1631	FFS operation not possible	+UDWNFILE
1632	FFS write error	+UDWNFILE
1633	FFS user id error	+UDWNFILE
1634	FFS internal fatal error	+UDWNFILE
1635	FFS memory resource error	+UDWNFILE
1636	FFS maximum number of files exceeded	+UDWNFILE
1637	FFS memory not available	+UDWNFILE
1638	FFS invalid filename	+UDWNFILE
1639	FFS streaming not enabled	+UDWNFILE
1640	FFS operation not allowed on static file	+UDWNFILE
1641	FFS memory table inconsistency	+UDWNFILE
1642	FFS not a factory default file	+UDWNFILE
1643	FFS requested memory temporary not available	+UDWNFILE
1644	FFS operation not allowed for a directory	+UDWNFILE
1645	FFS directory space not available	+UDWNFILE
1646	FFS too many streaming files open	+UDWNFILE
1647	FFS requested dynamic memory temporary not available	+UDWNFILE
1648	FFS user provided a NULL parameter instead of a suitable buffer	+UDWNFILE
1649	FFS timeout	+UDWNFILE
1650	Command line too long	All commands
1660	Call barred - Fixed dialing numbers only	D
1700	GPS GPIO not configured	+UGPS
1701	GPS GPIO ownership error	+UGPS
1702	Invalid operation with GPS ON	+UGPRF, +ULOC
1703	Invalid operation with GPS OFF	+UGPS, +UGTMR, +UGAOS, +UGUBX
1704	Invalid GPS aiding mode	+UGPS, +UGAOS
1705	Reserved GPS aiding mode	+UGPS
1706	GPS aiding mode already set	+UGPS
1707	Invalid GPS trace mode	+UGPRF
1708	Parameter valid only in case of GPS OTA	+UGPRF
1709	GPS trace invalid server	+UGPRF
1710	Invalid TimeZone	+UGTMR

<err>	Meaning	Resulting from the following commands
1711	Invalid value	+UGZDA, +UGGGA, +UGGLL, +UGGSV, +UGRMC, +UGVTG, +UGGSA
1712	Invalid parameter	+UGAOF, +UGAOP
1713	Invalid operation with LOC running / GPS Busy	+UGPS
1801	IBM busy / eCall already armed/active	+UECALLDATA
1802	IBM feature off / eCall feature off	+UECALLDATA, +UECALLVOICE
1803	Wrong IBM requested	(RFU)
1804	Audio resource not available	+UECALLDATA
1805	ECALL restriction	+COPS ⁵
1806	eCall invalid dial number	+UECALLTYPE, +UDCONF=90, +CECALL
1900	No SAP Server Connection	+USAPMODE
1901	SAP Protocol Error	+USAPMODE
1902	SAP Connection failure	+USAPMODE
1903	SAP Server Disconnection	+USAPMODE
1904	SAP Other terminal using service	+USAPMODE

A.8 Message service failure result codes +CMS ERROR

<err>	Meaning	Resulting from the following commands
1	Unassigned (unallocated) number	
5	Delta firmware unavailable on FOTA server	
8	Operator determined barring	
10	Call barred	
17	Network failure	
21	Short message transfer rejected	
22	Memory capacity exceeded	
27	Destination out of service	
28	Unidentified subscriber	
29	Facility rejected	
30	Unknown Subscriber	
38	Network out of order	
41	Temporary failure	
42	Congestion	
47	Resources unavailable, unspecified	
50	Requested facility not subscribed	
69	Requested facility not implemented	
81	Invalid short message reference value	
95	Invalid message, unspecified	
96	invalid mandatory information	
97	Message type non-existent or not implemented	
98	Message not compatible with short message protocol state	
99	Information element non-existent or not implemented	
111	Protocol error, unspecified	
127	Interworking, unspecified	
128	Telematic interworking not supported	
129	Short message type 0 not supported	
130	Cannot replace short message	
143	Unspecified TP-PID error	
144	Data coding scheme (alphabet) not supported	
145	Message class not supported	
159	Unspecified TP-DCS error	
160	Command cannot be actioned	
161	Command unsupported	

⁵ Only on LISA-U2 series modules



<err>	Meaning	Resulting from the following commands
175	Unspecified TP-Command error	
176	TPDU not supported	
192	SC busy	
193	No SC subscription	
194	SC system failure	
195	Invalid SME address	
196	Destination SME barred	
197	SM Rejected-Duplicate SM	
198	TP-VPF not supported	
199	TP-VP not supported	
208	SIM SMS storage full	
209	No SMS storage capability in SIM	
210	Error in MS	
211	Memory Capacity Exceeded	
212	SIM Application Toolkit Busy	
213	SIM data download error	
287	Network failure unspecified	
290	Network no resource	
296	Radio Resources not Available due to DUAL SIM operation	
297	Out of service due to DUAL SIM operation	
300	ME failure	
301	SMS service of ME reserved	+CSMS
302	Operation not allowed	all SMS commands
303	operation not supported	all SMS commands
305	Invalid Text mode parameter	
310	SIM not inserted	all SMS commands
311	SIM PIN necessary	all SMS commands
312	PH-SIM PIN necessary	all SMS commands
313	SIM failure	all SMS commands
314	SIM busy	all SMS commands
315	SIM wrong	all SMS commands, +COPS
320	memory failure	+CMGR, +UCMGP
321	invalid memory index	+CMGR, +CMGL, +UCMGR, +CMGD, +UCMGP
322	memory full	
330	SMSC address unknown	
331	no network service	
332	network timeout	+CNMA
340	no +CNMA acknowledgement expected	+CNMA
500	unknown error	commands with wrong syntax
512	Relay path Acknowledgement	commands with wrong syntax
513	SMS timer expired	commands with wrong syntax
514	SMS forwarding availability failed	commands with wrong syntax
515	SMS forwarding availability aborted	commands with wrong syntax
516	MS invalid TP-Message-Type-Indicator	
517	MS no TP-Status-Report in Phase 1	
518	MS no TP-Reject-Duplicate in phase 1	
519	MS no TP-Replay-Path in Phase 1	
520	MS no TP-User-Data-Header in Phase 1	
521	MS missing TP-Validity-Period	
522	MS invalid TP-Service-Centre-Time-Stamp	
523	MS missing TP-Destination-Address	
524	MS invalid TP-Destination-Address	
525	MS missing Service-Centre-Address	
526	MS invalid Service-Centre-Address	
527	MS invalid alphabet	



<err>	Meaning	Resulting from the following commands
528	MS invalid TP-User-Data-length	
529	MS missing TP-User-Data	
530	MS TP-User-Data too long	
531	MS no Command-Request in Phase 1	
532	MS Cmd-Req invalid TP-Destination-Address	
533	MS Cmd-Req invalid TP-User-Data-Length	
534	MS Cmd-Req invalid TP-User-Data	
535	MS Cmd-Req invalid TP-Command-Type	
536	MN MNR creation failed	
537	MS CMM creation failed	
538	MS network connection lost	
539	MS pending MO SM transfer	
540	RP-Error OK	
541	RP-Error OK no icon display	
542	SMS-PP Unspecified	
543	SMS rejected By SMS CONTROL	
544	Service Centre Address(SCA) FDN failed	
545	Destination Address(DA) FDN failed	
546	BDN check failed	
547	Unspecified SMS PP error	
548	Undefined Result	

A.9 +CEER error result codes

The following table lists the supported values for <cause> (Number) and <error_description> (String) for +CEER AT command if <type> assumes one of these values:

- "CC setup error"
- "CC modification error"
- "CC release"
- "SM attach error"
- "SM detach"
- "SM activation error"
- "SM deactivation"

In case the same <cause> values map to different <error_description> strings on the same product (see for instance <cause> 129 on SARA-G series), they obviously refer to different <type> values, related to CS call control or to PS session management failures.

<cause>	<error_description>	LEON-G	SARA-G	LISA-U	SARA-U
0	No cause information available			x	x
1	Unassigned (unallocated) number	x	x	x	x
3	No route to destination	x	x	x	x
6	Channel unacceptable	x	x	x	x
8	Operator determined barring	x	x	x	x
16	Normal call clearing	x	x	x	x
17	User busy	x	x	x	x
18	No user responding	x	x	x	x
19	User alerting, no answer	x	x	x	x
21	Call rejected	x	x	x	x
22	Number changed	x	x	x	x
26	Non selected user clearing	x	x	x	x
27	Destination out of order	x	x	x	x
28	Invalid number format (incomplete number)	x	x	x	x
29	Facility rejected	x	x	x	x
30	Response to STATUS ENQUIRY	x	x	x	x



<cause>	<error_description>	LEON-G	SARA-G	LISA-U	SARA-U
31	Normal, unspecified	x	x	x	x
34	No circuit/channel available	x	x	x	x
38	Network out of order	x	x	x	x
41	Temporary failure	x	x	x	x
42	Switching equipment congestion	x	x	x	x
43	Access information discarded	x	x	x	x
44	Requested circuit/channel not available	x	x	x	x
47	Resources unavailable, unspecified	x	x	x	x
49	Quality of service unavailable	x	x	x	x
50	Requested facility not subscribed	x	x	x	x
55	Incoming calls barred within the CUG	x	x	x	x
57	Bearer capability not authorized	x	x	x	x
58	Bearer capability not presently available	x	x	x	x
63	Service or option not available, unspecified	x	x	x	x
65	Bearer service not implemented	x	x	x	x
68	ACM equal to or greater than ACMmax	x	x	x	x
69	Requested facility not implemented	x	x	x	x
70	Only restr. digital information bearer capability	x	x	x	x
79	Service or option not implemented, unspecified	x	x	x	x
81	Invalid transaction identifier value	x	x	x	x
87	User not member of CUG	x	x	x	x
88	Incompatible destination	x	x	x	x
91	Invalid transit network selection	x	x	x	x
95	Semantically incorrect message	x	x	x	x
96	Invalid mandatory information	x	x	x	x
97	Message type non-existent or not implemented	x	x	x	x
98	Message type not compatible with protocol state	x	x	x	x
99	Information element non-existent or not implemented	x	x	x	x
100	Conditional IE error	x	x	x	x
101	Message not compatible with protocol state	x	x	x	x
102	Recovery on timer expiry	x	x	x	x
102	Unknown IMSI		x		
103	Illegal MS		x	x	x
106	Illegal ME		x	x	x
107	GPRS service not allowed		x	x	x
108	GPRS and non GPRS services not allowed		x		
111	Protocol error, unspecified	x	x	x	x
112	Location area not allowed	x		x	x
113	Roaming not allowed in this location area	x		x	x
125	LLC or SNDCP failure		x		
126	Insufficient resources		x		
127	Missing or unknown APN		x		
127	Interworking, unspecified	x	x	x	x
129	Outgoing calls barred within CUG	x	x		
129	User authentication failed		x		
130	No CUG selected	x	x		
131	Unknown CUG index	x	x		
131	Activation reject,unspecified		x		
132	CUG index incompatible with requested basic service	x	x		
132	Service not supported		x	x	x
133	CUG call failure, unspecified	x	x		
133	Requested service option not subscribed		x		
133	Service not subscribed			x	x
134	CLIR not subscribed	x	x		
134	Service option temporarily out of order		x		



<cause>	<error_description>	LEON-G	SARA-G	LISA-U	SARA-U
134	Service option temporarily out of order			x	x
135	CCBS possible	x	x		
135	NSAPI already used		x		
136	CCBS not possible	x	x		
136	Regular PDP context deactivation		x		
137	QoS not accepted		x		
138	Network failure		x		
148	Unspecified GPRS error		x	x	x
149	PDP authentication error		x	x	x
256	Internal, unspecified			x	x
257	Out of memory			x	x
258	Invalid parameters			x	x
259	Data call active			x	x
260	Speech call active			x	x
262	Missing ACM information			x	x
263	Temporary forbidden			x	x
264	Called party is blacklisted			x	x
265	Blacklist is full			x	x
266	No service			x	x
267	Limited service			x	x
268	Client conflict			x	x
269	Dual service call active			x	x
271	Unknown SIM error			x	x
274	Active Client is Gone			x	x
277	SIM status failure			x	x
278	Rejected by call control			x	x
279	FDN failed			x	x
280	BDN failed			x	x
283	CCBS possible			x	x
285	LND overflow			x	x
287	MM network failure unspecified			x	x
288	MM no service			x	x
289	MM access class barred			x	x
290	MM RR no resource			x	x
291	MM ME busy			x	x
292	MM unspecified			x	x
301	MMI not registered			x	x
303	Rejected by user			x	x
304	Rejected due to time out			x	x
306	Disconnected due to SIM-Toolkit call setup			x	x
307	Pending SIM-Toolkit call setup			x	x
310	SIM reset			x	x
340	MM sapi3 release			x	x
341	MM lower layer failure			x	x
342	MM authentication failure			x	x
343	MM PS reject			x	x
344	MM service rejected			x	x
345	MM abort by network			x	x
346	MM timeout			x	x
347	MM detach			x	x
348	MM RR connection release			x	x
349	MM not registered			x	x
350	MM re-establishment failure			x	x
351	Failure due to handover			x	x
352	Link establishment failure			x	x



<cause>	<error_description>	LEON-G	SARA-G	LISA-U	SARA-U
353	Random access failure			x	x
354	Radio link aborted			x	x
355	Lower layer failure in Layer 1			x	x
356	Immediate Assignment Reject			x	x
357	Failure due to paging			x	x
358	Abnormal release unspecified			x	x
359	Abnormal release channel unacceptable			x	x
360	Abnormal release timer expired			x	x
361	Abnormal release no act on radio path			x	x
362	Preemptive release			x	x
363	UTRAN configuration unknown			x	x
364	Handover impossible			x	x
365	Channel mode unacceptable			x	x
366	Frequency not implemented			x	x
367	Originator leaving call group area			x	x
368	Lower layer failure from network			x	x
369	Call already cleared			x	x
370	Semantically incorrect message			x	x
371	Invalid mandatory info			x	x
372	Message type non existing			x	x
373	Message type incompatible in state			x	x
374	Conditional information element error			x	x
375	No cell allocation available			x	x
376	Protocol error unspecified			x	x
377	Normal event			x	x
378	Unspecified			x	x
379	Preemptive release			x	x
380	Congestion			x	x
381	RE establishment reject			x	x
382	Directed sig conn establishment			x	x
383	User inactivity			x	x
384	Lower layer failure downlink			x	x
385	Lower layer failure uplink			x	x
386	Cell barred due to authentication failure			x	x
387	signalling connection release			x	x
388	CS connection release triggered by MM			x	x
389	RRC connection establishment failure			x	x
390	RRC connection establishment reject with redirection			x	x
391	resource conflict			x	x
392	Layer 2 sequence error			x	x
393	Layer 2 T200 exp N200 plus 1 times			x	x
394	Layer 2 unsolicited DM resp MFES			x	x
395	Layer 2 contention resolution			x	x
396	Layer 2 normal cause			x	x
397	RR connection release due to BAND change (2G)			x	x
400	MM RR connection error while release			x	x
500	Local user disconnect/normal call clearing			x	x
510	Remote user or NW disconnect\nnormal call clearing,during any other call state than "CALL PROCEEDING"			x	x
511	Remote user or NW disconnect\nnormal call clearing,during the call state "CALL PROCEEDING"			x	x

A.10 FWINSTALL error result codes

The `+UFWINSTALL` command returns error in case of syntax error and in case of problem during the install procedure.



Syntax error resulting from the +UFWINSTALL command:

Error string	Error Code	Description
+CME ERROR: FFS file not found	1624	The delta file is not in FFS or the file name is wrong
+CME ERROR: not supported	4	One of the following cases: <ul style="list-style-type: none"> wrong serial port number wrong baud rate excess number of parameters allowed excess file name length (47 characters)

Error code during the install procedure resulting from the +UFWINSTALL command:

Response	Description
128	General Success Code
129	General Failure Code
130	error in a run parameter
131	expected length error
132	structural error
133	signature error
134	given RAM is not enough
135	does not behave as RAM
136	memory allocation failure
137	flash writing failure
138	flash erasing failure
139	flash reading failure
140	one API function is not declared
141	backup buffer(s) not sector aligned
142	start address is not sector aligned
143	file does not exist
144	RO or no access rights
145	file does not exist
146	no access rights
147	cannot resize file
148	cannot read specified size
149	cannot close file handle
150	Failed creating symbolic link
151	Failed creating directory
152	bad operation number for update
153	unsupported compression
154	Can not apply reverse update for delta not generated as reverse delta
155	number of backup buffers given to UPI does not match number in delta file
156	Sector size mismatch between UPI and delta
157	UPI was not compiled to support reverse update
158	UPI was not compiled to support IFS on compressed images
159	UPI was not compiled to support IFS
160	Source mismatch in scout only operation
161	There is not enough RAM to run with operation=2 (Dry update)
162	Delta file too long - corrupted
163	Mismatch between deletes sig and delta deletes buffers signature
164	Number of fragments in section is not 1
165	Over all number of backup sects too big
166	Delta file is corrupt: signature mismatch between delta header signature and calculated signature
167	File signature does not match signature
168	Signature for the target buffer does not match the one stored in the delta file
169	Too many dirty buffers



Response	Description
170	UPI version mismatch between UPI and delta
171	Scout version mismatch between UPI and delta
172	Partition name is different in delta and in UPI data
173	There is not enough flash to update or install the files
174	There is not enough backup space on device
175	UPI does not support RW file system update
176	UPI does not support image update
177	Deployment Package header is invalid
178	Deployment Package signature is invalid
179	Deployment Package version is not supported
180	Requested ordinal does not exist in Deployment Package
181	Requested component was not found in Deployment Package

B Appendix: AT Commands List

AT command	LEON		SARA					LISA								
	G100-06S	G100-07S / G100-08S	G300-00S / G310-00S	G340-00S / G350-00S G350-00X	G340-01S / G350-01S G350-01B	U270-00S / U270-00S	U100 / U110	U120 / U130	U200-00S	U200-01S / U260-01S U270-01S	U230-01S	U2x0-02S	U200-52S	U200-62S	U200-82S	U270-62S
AUDIO																
<i>+UDBF</i>	•	•		•	•	•		•		•	•	•	•	•	•	•
<i>+UHFP</i>	•	•		•	•	•		•		•	•	•	•	•	•	•
<i>+UMGC</i>	•	•		•	•	•		•		•	•	•	•	•	•	•
<i>+USGC</i>	•	•		•	•	•		•		•	•	•	•	•	•	•
<i>+USTN</i>	•	•		•	•	•		•		•	•	•	•	•	•	•
<i>+UUBF</i>	•	•		•	•	•		•		•	•	•	•	•	•	•
AUDIOINTERFACE																
<i>+UDCONF=30</i>		•		•	•	•				•	•	•	•	•	•	•
<i>+UEXTDCONF</i>						•				•	•	•	•	•	•	•
<i>+UI2S</i>	•	•		•	•	•		•		•	•	•	•	•	•	•
<i>+UMCLK</i>						•		•		•	•	•	•	•	•	•
<i>+UMSM</i>	•	•		•	•	•		•		•	•	•	•	•	•	•
<i>+UPAR</i>	•	•		•	•	•		•		•	•	•	•	•	•	•
<i>+UPLAYFILE</i>	•	•		•	•	•		•		•	•	•	•	•	•	•
<i>+URNG</i>	•	•		•	•	•		•		•	•	•	•	•	•	•
<i>+USAR</i>	•	•		•	•	•		•		•	•	•	•	•	•	•
<i>+USPM</i>	•	•		•	•	•		•		•	•	•	•	•	•	•
<i>+USTOPFILE</i>	•	•		•	•	•		•		•	•	•	•	•	•	•
<i>+UTGN</i>	•	•		•	•	•		•		•	•	•	•	•	•	•
CALL																
<i>A</i>	•	•	•	•	•	•	•	•	•	•	•	•	•	•	•	•
<i>D</i>	•	•	•	•	•	•	•	•	•	•	•	•	•	•	•	•
<i>DL</i>	•	•		•	•	•	•	•	•	•	•	•	•	•	•	•
<i>D></i>	•	•		•	•	•	•	•	•	•	•	•	•	•	•	•
<i>L</i>	•	•		•	•	•	•	•	•	•	•	•	•	•	•	•
<i>M</i>	•	•		•	•	•	•	•	•	•	•	•	•	•	•	•
<i>P</i>	•	•		•	•	•	•	•	•	•	•	•	•	•	•	•
<i>SO</i>	•	•	•	•	•	•	•	•	•	•	•	•	•	•	•	•
<i>T</i>	•	•		•	•	•	•	•	•	•	•	•	•	•	•	•
<i>+CHUP</i>	•	•	•	•	•	•	•	•	•	•	•	•	•	•	•	•
<i>+CMOD</i>	•	•	•	•	•	•	•	•	•	•	•	•	•	•	•	•
<i>+CSNS</i>	•	•	•	•	•	•	•	•	•	•	•	•	•	•	•	•
<i>+CSTA</i>	•	•	•	•	•	•	•	•	•	•	•	•	•	•	•	•
<i>+CSVM</i>						•	•	•	•	•	•	•	•	•	•	•
<i>+UCALLSTAT</i>	•	•	•	•	•	•	•	•	•	•	•	•	•	•	•	•
<i>+UPROGRESS</i>						•	•	•	•	•	•	•	•	•	•	•
<i>+UVTS</i>						•	•	•	•	•	•	•	•	•	•	•
<i>+VTD</i>	•	•		•	•	•	•	•	•	•	•	•	•	•	•	•
<i>+VTS</i>	•	•		•	•	•	•	•	•	•	•	•	•	•	•	•
DATA																
<i>+CBST</i>	•	•	•	•	•	•	•	•	•	•	•	•	•	•	•	•
<i>+CEER</i>	•	•	•	•	•	•	•	•	•	•	•	•	•	•	•	•
<i>+CR</i>	•	•	•	•	•	•	•	•	•	•	•	•	•	•	•	•



AT command	LEON		SARA					LISA									
	G100-06S	G100-07S / G100-08S	G300-00S / G310-00S	G340-00S / G350-00S G350-00X	G340-01S / G350-01S G350-01B	U270-00S / U270-00S	U100 / U110	U120 / U130	U200-00S	U200-01S / U260-01S U270-01S	U230-01S	U2x0-02S	U200-52S	U200-62S	U200-82S	U270-62S	
+CRC	•	•	•	•	•	•	•	•	•	•	•	•	•	•	•	•	
+CRLP	•	•	•	•	•	•	•	•	•	•	•	•	•	•	•	•	
+FCLASS	•	•	•	•	•	•	•	•	•	•	•	•	•	•	•	•	
+UCEER							•	•	•								
+UCSD	•	•															
+UCSDA	•	•															
+UCSND	•	•															
+UDCONF=32						•			•	•	•	•	•	•	•	•	
DNS																	
+UDYDNS				•	•	•					•	•	•	•	•	•	
+UDNSRN	•	•		•	•	•	•	•	•	•	•	•	•	•	•	•	
DTMF																	
+UDCONF=31						•			•	•	•	•	•	•	•	•	
+UDTMF						•		•	•	•	•	•	•	•	•	•	
+UDTMFD		•		•	•	•					•	•	•	•	•	•	
ECALL																	
+CECALL	•	•				•											
+UDCONF=90		•				•											
+UECALLDATA		•		•	•	•					•	•	•	•	•	•	
+UECALLSTAT		•		•	•	•		•			•	•	•	•	•	•	
+UECALLTYPE		•		•	•	•		•			•	•	•	•	•	•	
+UECALLVOICE		•		•	•	•					•	•	•	•	•	•	
FAX																	
+FAA	•	•		•	•												
+FAP	•	•		•	•												
+FBO	•	•		•	•												
+FBS	•	•		•	•												
+FBU	•	•		•	•												
+FCC	•	•		•	•												
+FCQ	•	•		•	•												
+FCR	•	•		•	•												
+FCS	•	•		•	•												
+FCT	•	•		•	•												
+FDR	•	•		•	•												
+FDT	•	•		•	•												
+FEA	•	•		•	•												
+FFC	•	•		•	•												
+FFD	•	•		•	•												
+FHS	•	•		•	•												
+FIE	•	•		•	•												
+FIP	•	•		•	•												
+FIS	•	•		•	•												
+FIT	•	•		•	•												
+FK	•	•		•	•												
+FLI	•	•		•	•												
+FLO	•	•		•	•												
+FLP	•	•		•	•												



AT command	LEON		SARA					LISA									
	G100-06S	G100-07S / G100-08S	G300-00S / G310-00S	G340-00S / G350-00S G350-00X	G340-01S / G350-01S G350-01B	U270-00S / U270-00S	U100 / U110	U120 / U130	U200-00S	U200-01S / U260-01S U270-01S	U230-01S	U2x0-02S	U200-52S	U200-62S	U200-82S	U270-62S	
+FMI	•	•		•	•												
+FMM	•	•		•	•												
+FMR	•	•		•	•												
+FMS	•	•		•	•												
+FND	•	•		•	•												
+FNR	•	•		•	•												
+FNS	•	•		•	•												
+FPA	•	•		•	•												
+FPI	•	•		•	•												
+FPP	•	•		•	•												
+FPS	•	•		•	•												
+FPW	•	•		•	•												
+FRQ	•	•		•	•												
+FRY	•	•		•	•												
+FSA	•	•		•	•												
+FSP	•	•		•	•												
FILESYSTEM																	
+UDELFIL	•	•		•	•	•	•	•	•	•	•	•	•	•	•	•	
+UDWNFIL	•	•		•	•	•	•	•	•	•	•	•	•	•	•	•	
+ULSTFIL	•	•		•	•	•	•	•	•	•	•	•	•	•	•	•	
+URDBLOCK	•	•		•	•	•	•	•	•	•	•	•	•	•	•	•	
+URDFIL	•	•		•	•	•	•	•	•	•	•	•	•	•	•	•	
FTP																	
+UFTP	•	•		•	•	•	•	•	•	•	•	•	•	•	•	•	
+UFTPC	•	•		•	•	•	•	•	•	•	•	•	•	•	•	•	
+UFTPER	•	•		•	•	•	•	•	•	•	•	•	•	•	•	•	
GENERAL																	
A/	•	•	•	•	•	•	•	•	•	•	•	•	•	•	•	•	
I	•	•	•	•	•	•	•	•	•	•	•	•	•	•	•	•	
&H	•	•	•	•	•	•	•	•	•	•	•	•	•	•	•	•	
+CCID	•	•	•	•	•	•	•	•	•	•	•	•	•	•	•	•	
+CGMI	•	•	•	•	•	•	•	•	•	•	•	•	•	•	•	•	
+CGMM	•	•	•	•	•	•	•	•	•	•	•	•	•	•	•	•	
+CGMR	•	•	•	•	•	•	•	•	•	•	•	•	•	•	•	•	
+CGSN	•	•	•	•	•	•	•	•	•	•	•	•	•	•	•	•	
+CIMI	•	•	•	•	•	•	•	•	•	•	•	•	•	•	•	•	
+CLAC	•	•	•	•	•	•	•	•	•	•	•	•	•	•	•	•	
+CSCS	•	•	•	•	•	•	•	•	•	•	•	•	•	•	•	•	
+GCAP	•	•	•	•	•	•	•	•	•	•	•	•	•	•	•	•	
+GMI	•	•	•	•	•	•	•	•	•	•	•	•	•	•	•	•	
+GMM	•	•	•	•	•	•	•	•	•	•	•	•	•	•	•	•	
+GMR	•	•	•	•	•	•	•	•	•	•	•	•	•	•	•	•	
+GSN	•	•	•	•	•	•	•	•	•	•	•	•	•	•	•	•	
GPIO																	
+UGPIOC	•	•		•	•	•	•	•	•	•	•	•	•	•	•	•	
+UGPIOR	•	•		•	•	•	•	•	•	•	•	•	•	•	•	•	
+UGPIOW	•	•		•	•	•	•	•	•	•	•	•	•	•	•	•	



AT command	LEON		SARA					LISA								
	G100-06S	G100-07S / G100-08S	G300-00S / G310-00S	G340-00S / G350-00S G350-00X	G340-01S / G350-01S G350-01B	U270-00S / U270-00S	U100 / U110	U120 / U130	U200-00S	U200-01S / U260-01S U270-01S	U230-01S	U2x0-02S	U200-52S	U200-62S	U200-82S	U270-62S
GPRS																
<i>D*</i>	•	•	•	•	•		•	•	•	•	•	•	•	•	•	•
<i>H</i>	•	•	•	•	•	•	•	•	•	•	•	•	•	•	•	•
<i>+CGACT</i>	•	•	•	•	•	•	•	•	•	•	•	•	•	•	•	•
<i>+CGANS</i>														•		
<i>+CGATT</i>	•	•	•	•	•	•	•	•	•	•	•	•	•	•	•	•
<i>+CGAUTO</i>														•		
<i>+CGCLASS</i>	•	•	•	•	•	•	•	•	•	•	•	•	•	•	•	•
<i>+CGCMOD</i>																
<i>+CGDATA</i>	•	•	•	•	•	•	•	•	•	•	•	•	•	•	•	•
<i>+CGDCONT</i>	•	•	•	•	•	•	•	•	•	•	•	•	•	•	•	•
<i>+CGDSCONT</i>																
<i>+CGEQMIN</i>																
<i>+CGEQNEG</i>																
<i>+CGEQREQ</i>																
<i>+CGEREP</i>	•	•	•	•	•	•	•	•	•	•	•	•	•	•	•	•
<i>+CGPADDR</i>	•	•	•	•	•	•	•	•	•	•	•	•	•	•	•	•
<i>+CGPERMACT</i>																•
<i>+CGPERMSET</i>																•
<i>+CGPERMSTATE</i>																•
<i>+CGQMIN</i>	•	•	•	•	•	•	•	•	•	•	•	•	•	•	•	•
<i>+CGQREQ</i>	•	•	•	•	•	•	•	•	•	•	•	•	•	•	•	•
<i>+CGREG</i>	•	•	•	•	•	•	•	•	•	•	•	•	•	•	•	•
<i>+CGSMS</i>	•	•	•	•	•	•	•	•	•	•	•	•	•	•	•	•
<i>+CGTFT</i>																
<i>+UCGCLASS</i>																
<i>+UCLASS</i>	•	•	•	•	•	•	•	•	•	•	•	•	•	•	•	•
<i>+UGCNTRD</i>	•	•	•	•	•	•	•	•	•	•	•	•	•	•	•	•
<i>+UGCNTSET</i>	•	•	•	•	•	•	•	•	•	•	•	•	•	•	•	•
<i>+UPSD</i>	•	•		•	•	•	•	•	•	•	•	•	•	•	•	•
<i>+UPSDA</i>	•	•		•	•	•	•	•	•	•	•	•	•	•	•	•
<i>+UPSND</i>	•	•		•	•	•	•	•	•	•	•	•	•	•	•	•
<i>+UREG</i>							•	•	•	•	•	•	•	•	•	•
GPS																
<i>+UGAOF</i>	•	•		•	•	•	•	•		•	•	•	•	•	•	•
<i>+UGAOP</i>	•	•		•	•	•	•	•		•	•	•	•	•	•	•
<i>+UGAOS</i>	•	•		•	•	•	•	•		•	•	•	•	•	•	•
<i>+UGGGA</i>	•	•		•	•	•	•	•		•	•	•	•	•	•	•
<i>+UGGLL</i>	•	•		•	•	•	•	•		•	•	•	•	•	•	•
<i>+UGGSA</i>	•	•		•	•	•	•	•		•	•	•	•	•	•	•
<i>+UGGSV</i>	•	•		•	•	•	•	•		•	•	•	•	•	•	•
<i>+UGIND</i>	•	•		•	•	•	•	•		•	•	•	•	•	•	•
<i>+UGPRF</i>	•	•		•	•	•	•	•		•	•	•	•	•	•	•
<i>+UGPS</i>	•	•		•	•	•	•	•		•	•	•	•	•	•	•
<i>+UGRMC</i>	•	•		•	•	•	•	•		•	•	•	•	•	•	•
<i>+UGSRV</i>					•	•										
<i>+UGTMR</i>	•	•		•	•	•	•	•		•	•	•	•	•	•	•



AT command	LEON		SARA					LISA									
	G100-06S	G100-07S / G100-08S	G300-00S / G310-00S	G340-00S / G350-00S G350-00X	G340-01S / G350-01S G350-01B	U270-00S / U270-00S	U100 / U110	U120 / U130	U200-00S	U200-01S / U260-01S U270-01S	U230-01S	U2x0-02S	U200-52S	U200-62S	U200-82S	U270-62S	
<i>+UGUBX</i>	•	•		•	•	•	•	•		•	•	•	•	•	•	•	
<i>+UGVTG</i>	•	•		•	•	•	•	•		•	•	•	•	•	•	•	
<i>+UGZDA</i>	•	•		•	•	•	•	•		•	•	•	•	•	•	•	
<i>+ULOC</i>	•	•		•	•	•	•	•		•	•	•	•	•	•	•	
<i>+ULOCCELL</i>	•	•		•	•	•	•	•		•	•	•	•	•	•	•	
<i>+ULOCGNS</i>	•	•		•	•	•	•	•		•	•	•	•	•	•	•	
HTTP																	
<i>+UHHTTP</i>	•	•		•	•	•	•	•	•	•	•	•	•	•	•	•	
<i>+UHHTTPC</i>	•	•		•	•	•	•	•	•	•	•	•	•	•	•	•	
<i>+UHHTTPER</i>	•	•		•	•	•	•	•	•	•	•	•	•	•	•	•	
I2C																	
<i>+UI2CC</i>						•				•	•	•	•	•	•	•	
<i>+UI2CO</i>						•				•	•	•	•	•	•	•	
<i>+UI2CR</i>						•				•	•	•	•	•	•	•	
<i>+UI2CREGR</i>						•				•	•	•	•	•	•	•	
<i>+UI2CW</i>						•				•	•	•	•	•	•	•	
IPC																	
<i>+CMUX</i>	•	•	•	•	•	•	•	•	•	•	•	•	•	•	•	•	
NETWORK																	
<i>+CGED</i>	•	•	•	•	•	•	•	•	•	•	•	•	•	•	•	•	
<i>+CNUM</i>	•	•		•	•	•	•	•	•	•	•	•	•	•	•	•	
<i>+COPN</i>	•	•	•	•	•	•	•	•	•	•	•	•	•	•	•	•	
<i>+COPS</i>	•	•	•	•	•	•	•	•	•	•	•	•	•	•	•	•	
<i>+CPLS</i>						•	•	•	•	•	•	•	•	•	•	•	
<i>+CPOL</i>	•	•	•	•	•	•	•	•	•	•	•	•	•	•	•	•	
<i>+CREG</i>	•	•	•	•	•	•	•	•	•	•	•	•	•	•	•	•	
<i>+CSQ</i>	•	•	•	•	•	•	•	•	•	•	•	•	•	•	•	•	
<i>+PACSP</i>						•	•	•	•	•	•	•	•	•	•	•	
<i>+UBANDSEL</i>	•	•	•	•	•	•	•	•	•	•	•	•	•	•	•	•	
<i>+UCD</i>	•	•		•	•	•	•	•	•	•	•	•	•	•	•	•	
<i>+UCELLINFO</i>						•	•	•	•	•	•	•	•	•	•	•	
<i>+UCELLOCK</i>		•		•	•	•	•	•		•	•	•	•	•	•	•	
<i>+UCGOPS</i>	•	•	•	•	•	•	•	•	•	•	•	•	•	•	•	•	
<i>+UDCONF=20</i>		•	•	•	•	•	•	•		•	•	•	•	•	•	•	
<i>+UDCONF=61</i>						•	•	•		•	•	•	•	•	•	•	
<i>+UDCONF=81</i>						•	•	•		•	•	•	•	•	•	•	
<i>+UDOPN</i>	•	•	•	•	•	•	•	•	•	•	•	•	•	•	•	•	
<i>+UEONS</i>	•	•	•	•	•	•	•	•	•	•	•	•	•	•	•	•	
<i>+UFDAC</i>						•	•	•	•	•	•	•	•	•	•	•	
<i>+UHOMEZR</i>						•	•	•	•	•	•	•	•	•	•	•	
<i>+UHSDUPA</i>						•	•	•	•	•	•	•	•	•	•	•	
<i>+URAT</i>						•	•	•	•	•	•	•	•	•	•	•	
<i>+WS46</i>						•	•	•	•	•	•	•	•	•	•	•	
PHONEBOOK																	
<i>+CPBF</i>	•	•		•	•	•	•	•	•	•	•	•	•	•	•	•	
<i>+CPBR</i>	•	•		•	•	•	•	•	•	•	•	•	•	•	•	•	
<i>+CPBS</i>	•	•		•	•	•	•	•	•	•	•	•	•	•	•	•	



AT command	LEON		SARA					LISA									
	G100-06S	G100-07S / G100-08S	G300-00S / G310-00S	G340-00S / G350-00S G350-00X	G340-01S / G350-01S G350-01B	U270-00S / U270-00S	U100 / U110	U120 / U130	U200-00S	U200-01S / U260-01S U270-01S	U230-01S	U2x0-02S	U200-52S	U200-62S	U200-82S	U270-62S	
<i>+CPBW</i>	•	•		•	•	•	•	•	•	•	•	•	•	•	•	•	
PING																	
<i>+UDCONF=4</i>				•	•	•				•	•	•	•	•	•	•	
<i>+UPING</i>	•	•		•	•	•				•	•	•	•	•	•	•	
SAP																	
<i>+USAPIND</i>						•				•	•	•	•	•	•	•	
<i>+USAPMODE</i>						•				•	•	•	•	•	•	•	
SECURITY																	
<i>+CLCK</i>	•	•	•	•	•	•	•	•	•	•	•	•	•	•	•	•	
<i>+CPIN</i>	•	•	•	•	•	•	•	•	•	•	•	•	•	•	•	•	
<i>+CPWD</i>	•	•	•	•	•	•	•	•	•	•	•	•	•	•	•	•	
<i>+UPINCNT</i>	•	•	•	•	•	•	•	•	•	•	•	•	•	•	•	•	
<i>+USIMLCK</i>	•	•	•	•	•	•	•	•	•	•	•	•	•	•	•	•	
SERVICES																	
<i>+CACM</i>	•	•	•	•	•	•	•	•	•	•	•	•	•	•	•	•	
<i>+CAMM</i>	•	•	•	•	•	•	•	•	•	•	•	•	•	•	•	•	
<i>+CAOC</i>	•	•	•	•	•	•	•	•	•	•	•	•	•	•	•	•	
<i>+CCFC</i>	•	•	•	•	•	•	•	•	•	•	•	•	•	•	•	•	
<i>+CCUG</i>	•	•	•	•	•	•	•	•	•	•	•	•	•	•	•	•	
<i>+CCWA</i>	•	•	•	•	•	•	•	•	•	•	•	•	•	•	•	•	
<i>+CHLD</i>	•	•	•	•	•	•	•	•	•	•	•	•	•	•	•	•	
<i>+CLCC</i>	•	•	•	•	•	•	•	•	•	•	•	•	•	•	•	•	
<i>+CLIP</i>	•	•	•	•	•	•	•	•	•	•	•	•	•	•	•	•	
<i>+CLIR</i>	•	•	•	•	•	•	•	•	•	•	•	•	•	•	•	•	
<i>+CNAP</i>	•	•	•	•	•	•	•	•	•	•	•	•	•	•	•	•	
<i>+COLP</i>	•	•	•	•	•	•	•	•	•	•	•	•	•	•	•	•	
<i>+COLR</i>	•	•	•	•	•	•	•	•	•	•	•	•	•	•	•	•	
<i>+CPUC</i>	•	•	•	•	•	•	•	•	•	•	•	•	•	•	•	•	
<i>+CSSN</i>	•	•	•	•	•	•	•	•	•	•	•	•	•	•	•	•	
<i>+CTFR</i>	•	•	•	•	•	•	•	•	•	•	•	•	•	•	•	•	
<i>+CUSD</i>	•	•	•	•	•	•	•	•	•	•	•	•	•	•	•	•	
<i>+CUUSI</i>	•	•	•	•	•	•											
SIM																	
<i>+SATD</i>						•	•	•	•	•	•	•	•	•	•	•	
<i>+SATE</i>						•	•	•	•	•	•	•	•	•	•	•	
<i>+SATR</i>						•	•	•	•	•	•	•	•	•	•	•	
<i>+STKCTRLIND</i>						•	•	•	•	•	•	•	•	•	•	•	
<i>+STKENV</i>	•	•	•	•	•	•	•	•	•	•	•	•	•	•	•	•	
<i>+STKPRO</i>	•	•	•	•	•	•	•	•	•	•	•	•	•	•	•	•	
<i>+STKPROF</i>	•	•	•	•	•	•	•	•	•	•	•	•	•	•	•	•	
<i>+STKTR</i>	•	•	•	•	•	•	•	•	•	•	•	•	•	•	•	•	
SIMMANAGEMENT																	
<i>+CLAN</i>						•	•	•	•	•	•	•	•	•	•	•	
<i>+CRSM</i>	•	•	•	•	•	•	•	•	•	•	•	•	•	•	•	•	
<i>+CSIM</i>	•	•	•	•	•	•	•	•	•	•	•	•	•	•	•	•	
<i>+UCSP</i>						•	•	•	•	•	•	•	•	•	•	•	
<i>+UDCONF=50</i>						•	•	•	•	•	•	•	•	•	•	•	



AT command	LEON		SARA					LISA									
	G100-06S	G100-07S / G100-08S	G300-00S / G310-00S	G340-00S / G350-00S G350-00X	G340-01S / G350-01S G350-01B	U270-00S / U270-00S	U100 / U110	U120 / U130	U200-00S	U200-01S / U260-01S U270-01S	U230-01S	U2x0-02S	U200-52S	U200-62S	U200-82S	U270-62S	
<i>+UICC</i>						•	•	•	•	•	•	•	•	•	•	•	
SMS																	
<i>+CMGD</i>	•	•	•	•	•	•	•	•	•	•	•	•	•	•	•	•	
<i>+CMGF</i>	•	•	•	•	•	•	•	•	•	•	•	•	•	•	•	•	
<i>+CMGL</i>	•	•	•	•	•	•	•	•	•	•	•	•	•	•	•	•	
<i>+CMGR</i>	•	•	•	•	•	•	•	•	•	•	•	•	•	•	•	•	
<i>+CMGS</i>	•	•	•	•	•	•	•	•	•	•	•	•	•	•	•	•	
<i>+CMGW</i>	•	•	•	•	•	•	•	•	•	•	•	•	•	•	•	•	
<i>+CMMS</i>						•	•	•	•	•	•	•	•	•	•	•	
<i>+CMSS</i>	•	•	•	•	•	•	•	•	•	•	•	•	•	•	•	•	
<i>+CNMA</i>	•	•	•	•	•	•	•	•	•	•	•	•	•	•	•	•	
<i>+CNMI</i>	•	•	•	•	•	•	•	•	•	•	•	•	•	•	•	•	
<i>+CPMS</i>	•	•	•	•	•	•	•	•	•	•	•	•	•	•	•	•	
<i>+CRES</i>	•	•	•	•	•	•	•	•	•	•	•	•	•	•	•	•	
<i>+CSAS</i>	•	•	•	•	•	•	•	•	•	•	•	•	•	•	•	•	
<i>+CSCA</i>	•	•	•	•	•	•	•	•	•	•	•	•	•	•	•	•	
<i>+CSCB</i>	•	•	•	•	•	•	•	•	•	•	•	•	•	•	•	•	
<i>+CSDH</i>	•	•	•	•	•	•	•	•	•	•	•	•	•	•	•	•	
<i>+CSMP</i>	•	•	•	•	•	•	•	•	•	•	•	•	•	•	•	•	
<i>+CSMS</i>	•	•	•	•	•	•	•	•	•	•	•	•	•	•	•	•	
<i>+UCMGL</i>	•	•	•	•	•	•											
<i>+UCMGP</i>							•			•	•	•	•	•	•	•	
<i>+UCMGR</i>	•	•	•	•	•	•											
<i>+UCMGS</i>	•	•	•	•	•	•											
<i>+UCMGW</i>	•	•	•	•	•	•											
<i>+UMWI</i>						•				•	•	•	•	•	•	•	
SMTP																	
<i>+USMTP</i>	•	•		•	•												
<i>+USMTPC</i>	•	•		•	•												
<i>+USMTPER</i>	•	•		•	•												
<i>+USMTPM</i>	•	•		•	•												
SPECIFIC																	
<i>+UADC</i>	•	•															
<i>+UANTR</i>	•	•		•	•	•	•	•	•	•	•	•	•	•	•	•	
<i>+UDATACHANNEL</i>							•	•	•	•	•	•	•	•	•	•	
<i>+UDCONF=0</i>	•	•	•	•	•												
<i>+UDCONF=40</i>							•			•	•	•	•	•	•	•	
<i>+UDCONF=66</i>							•										
<i>+UFWINSTALL</i>															•		
<i>+UFWUPD</i>	•	•	•	•	•	•	•	•	•	•	•	•	•	•	•	•	
<i>+UPSV</i>	•	•	•	•	•	•	•	•	•	•	•	•	•	•	•	•	
<i>+URING</i>						•					•	•	•	•	•	•	
<i>+URXDIV</i>																	
<i>+USTS</i>	•	•		•	•	•	•	•	•	•	•	•	•	•	•	•	
<i>+UTEST</i>	•	•	•	•	•	•	•	•	•	•	•	•	•	•	•	•	
STATUS																	
<i>+CALA</i>	•	•		•	•	•	•	•	•	•	•	•	•	•	•	•	



AT command	LEON		SARA					LISA								
	G100-06S	G100-07S / G100-08S	G300-00S / G310-00S	G340-00S / G350-00S G350-00X	G340-01S / G350-01S G350-01B	U270-00S / U270-00S	U100 / U110	U120 / U130	U200-00S	U200-01S / U260-01S U270-01S	U230-01S	U2x0-02S	U200-52S	U200-62S	U200-82S	U270-62S
+CALD	•	•		•	•	•	•	•	•	•	•	•	•	•	•	•
+CALM	•	•		•	•	•	•	•	•	•	•	•	•	•	•	•
+CCLK	•	•	•	•	•	•	•	•	•	•	•	•	•	•	•	•
+CCWE	•	•	•	•	•	•	•	•	•	•	•	•	•	•	•	•
+CFUN	•	•	•	•	•	•	•	•	•	•	•	•	•	•	•	•
+CIND	•	•	•	•	•	•	•	•	•	•	•	•	•	•	•	•
+CLVL	•	•		•	•	•	•	•	•	•	•	•	•	•	•	•
+CMEE	•	•	•	•	•	•	•	•	•	•	•	•	•	•	•	•
+CMER	•	•	•	•	•	•	•	•	•	•	•	•	•	•	•	•
+CMUT	•	•		•	•	•	•	•	•	•	•	•	•	•	•	•
+CPAS	•	•	•	•	•	•	•	•	•	•	•	•	•	•	•	•
+CPWROFF	•	•	•	•	•	•	•	•	•	•	•	•	•	•	•	•
+CRSL	•	•		•	•	•	•	•	•	•	•	•	•	•	•	•
+CSGT	•	•	•	•	•	•	•	•	•	•	•	•	•	•	•	•
+CTZR	•	•	•	•	•	•	•	•	•	•	•	•	•	•	•	•
+CTZU	•	•	•	•	•	•	•	•	•	•	•	•	•	•	•	•
+UCIND						•	•	•	•	•	•	•	•	•	•	•
TCP																
+UDCONF=1	•	•		•	•	•	•	•	•	•	•	•	•	•	•	•
+UDCONF=2							•	•	•	•						
+UDCONF=3							•	•	•	•						
+UDCONF=5				•	•	•					•	•	•			
+UDCONF=6				•	•	•					•	•	•			
+UDCONF=7				•	•	•					•	•	•			
+UDCONF=8				•	•	•					•	•	•			
+UFRW	•	•														
+UIPCHGN				•	•	•				•		•	•	•	•	•
+USOAO				•	•	•					•	•	•	•	•	•
+USOCL	•	•		•	•	•	•	•	•	•	•	•	•	•	•	•
+USOCO	•	•		•	•	•	•	•	•	•	•	•	•	•	•	•
+USOCR	•	•		•	•	•	•	•	•	•	•	•	•	•	•	•
+USOCTL	•	•		•	•	•	•	•	•	•	•	•	•	•	•	•
+USODL	•	•		•	•	•	•	•	•	•	•	•	•	•	•	•
+USOER	•	•		•	•	•	•	•	•	•	•	•	•	•	•	•
+USOGO	•	•		•	•	•	•	•	•	•	•	•	•	•	•	•
+USOLI	•	•		•	•	•	•	•	•	•	•	•	•	•	•	•
+USORD	•	•		•	•	•	•	•	•	•	•	•	•	•	•	•
+USORF	•	•		•	•	•	•	•	•	•	•	•	•	•	•	•
+USOSO	•	•		•	•	•	•	•	•	•	•	•	•	•	•	•
+USOST	•	•		•	•	•	•	•	•	•	•	•	•	•	•	•
+USOWR	•	•		•	•	•	•	•	•	•	•	•	•	•	•	•
V24																
E	•	•	•	•	•	•	•	•	•	•	•	•	•	•	•	•
O	•	•	•	•	•	•	•	•	•	•	•	•	•	•	•	•
Q	•	•	•	•	•	•	•	•	•	•	•	•	•	•	•	•
S10	•	•	•	•	•	•	•	•	•	•	•	•	•	•	•	•
S12	•	•	•	•	•	•	•	•	•	•	•	•	•	•	•	•

AT command	LEON		SARA				LISA									
	G100-06S	G100-07S / G100-08S	G300-00S / G310-00S	G340-00S / G350-00S G350-00X	G340-01S / G350-01S G350-01B	U270-00S / U270-00S	U100 / U110	U120 / U130	U200-00S	U200-01S / U260-01S U270-01S	U230-01S	U2x0-02S	U200-52S	U200-62S	U200-82S	U270-62S
S2	•	•	•	•	•	•	•	•	•	•	•	•	•	•	•	•
S3	•	•	•	•	•	•	•	•	•	•	•	•	•	•	•	•
S4	•	•	•	•	•	•	•	•	•	•	•	•	•	•	•	•
S5	•	•	•	•	•	•	•	•	•	•	•	•	•	•	•	•
S6	•	•	•	•	•	•	•	•	•	•	•	•	•	•	•	•
S7	•	•	•	•	•	•	•	•	•	•	•	•	•	•	•	•
S8	•	•	•	•	•	•	•	•	•	•	•	•	•	•	•	•
V	•	•	•	•	•	•	•	•	•	•	•	•	•	•	•	•
X	•	•	•	•	•	•	•	•	•	•	•	•	•	•	•	•
Z	•	•	•	•	•	•	•	•	•	•	•	•	•	•	•	•
&C	•	•	•	•	•	•	•	•	•	•	•	•	•	•	•	•
&D	•	•	•	•	•	•	•	•	•	•	•	•	•	•	•	•
&F	•	•	•	•	•	•	•	•	•	•	•	•	•	•	•	•
&K	•	•	•	•	•	•	•	•	•	•	•	•	•	•	•	•
&S	•	•	•	•	•	•	•	•	•	•	•	•	•	•	•	•
&V	•	•	•	•	•	•	•	•	•	•	•	•	•	•	•	•
&W	•	•	•	•	•	•	•	•	•	•	•	•	•	•	•	•
&Y	•	•	•	•	•	•	•	•	•	•	•	•	•	•	•	•
+ICF	•	•	•	•	•	•	•	•	•	•	•	•	•	•	•	•
+IFC	•	•	•	•	•	•	•	•	•	•	•	•	•	•	•	•
+IPR	•	•	•	•	•	•	•	•	•	•	•	•	•	•	•	•
+UTPB			•	•	•	•					•	•	•	•	•	•
\Q	•	•	•	•	•	•	•	•	•	•	•	•	•	•	•	•

B.1 Parameters stored in profiles

The parameter settings of some commands can be stored in the profiles available in the memory module. To store, partially display, activate and de-activate these profiles, refer to *AT&W*, *AT&V*, *AT&Y* command description.

Not all the parameter setting are displayed through with *AT&V* command.

Some AT commands have a unique configuration for all the AT interfaces while for other AT commands it is possible to set a different configuration for each AT interface: the "AT interface configuration sharing" column in the next table provides this information.

Some AT command interfaces have a dynamic activation, which means they are not statically activated at boot time (MUX AT channel is activated when the MUX protocol is established, USB AT channel is activated if/when the USB cable is plugged-in, deactivated when it is removed). Since the activation reloads the AT command profile from NVM for the activated interface, the shared "AT interface configurations" could be overwritten. It is suggested to reconfigure them at the requested value if an AT command interface is dynamically activated.

The following table lists the AT commands which setting can be stored in the profiles with their parameters as well as the factory-programmed values.

AT command	Description	AT interface configuration sharing	Factory-programmed value	Comment
&C	DCD Status	No	1	DCD enabled



AT command	Description	AT interface configuration sharing	Factory-programmed value	Comment
&D	DTR Status	No	1	DTR enabled
&K	Flow control status	No	3	RTS/CTS DTE flow control enabled
&S	DSR override	No	1	DSR line set to OFF
+CBST	Bearer service type (speed/ name/ connection element)	Yes	On LEON-G1 / SARA-G3 7,0,1	On LEON-G1 / SARA-G3 series <ul style="list-style-type: none"> Speed: 9600 b/s (V.32) Name: data circuit asynchronous Connection element: non-transparent
			On LISA-U 71,0,1	On LISA-U series <ul style="list-style-type: none"> Speed: 9600 b/s (V110 or X.31 flag stuffing) Name: data circuit asynchronous Connection element: non-transparent
+CMGF	Preferred message format	Yes	0	Format of messages in PDU mode
+CNMI	New message indication	Yes	1,0,0,0,0	<ul style="list-style-type: none"> Discard indication and reject new received message URCs when MT-DTE link is reserved No SMS-DELIVER indications are routed to the TE No CBM indications to the DTE No SMS-STATUS-REPORTs are routed to the DTE
+COPS	Operator selection	Yes	0, 0, FFFF	<ul style="list-style-type: none"> Autoregistration enabled (<mode>: 0) Operator expressed in long alphanumeric format (<format>: 0) PLMN to register when COPS=1 (FFFF: undefined)
+CR	Reporting control status	No	0	Reporting disabled
+CRC	Cellular result code status	No	0	Extended format disabled
+CRLP	Radio Link protocol settings	Yes	61,61,48,7	Standard configuration for radio link protocol <ul style="list-style-type: none"> IWF to MT window size: 61 MT to IWF window size: 61 Acknowledgement timer: 48 Retransmission attempts: 7
			On LISA-U / LEON-G1 / SARA-G3x0-00S / SARA-G3x0-00X: 61,61,48,6	Standard configuration for radio link protocol <ul style="list-style-type: none"> IWF to MT window size: 61 MT to IWF window size: 61 Acknowledgement timer: 48 Retransmission attempts: 6
+ICF	DTE-DCE character framing	No	On LEON-G1 / SARA-G 0,0	On LEON-G1 / SARA-G series <ul style="list-style-type: none"> Framing format autodetected
			On LISA-U 3,1	On LISA-U series <ul style="list-style-type: none"> Framing format: 8 data 1 stop, no parity
+IFC	DTE-DCE local flow control	No	2,2	<ul style="list-style-type: none"> <DCE_by_DTE> on circuit 106 (CTS) <DTE_by_DCE> on circuit 105 (RTS)
+IPR	Baud rate	No	On LEON-G1: • 0	On LEON-G1 series: • Autobauding enabled
			On LISA-U1 series and LISA-U200-00S version: • 115200	On LISA-U1 series and LISA-U200-00S version: • 115200 b/s
			On LISA-U2: • 0	On LISA-U2 series: • Autobauding enabled
+UDBF	Downlink Biquad Digital Filters	Yes	On LEON-G1 series: Path 0: Filter1: 0, 0, 0, 0, 32767	On LEON-G1 series: Path 0: <ul style="list-style-type: none"> Filter1: a1:0, b1:0, a2:0, b2:0, a0:32767 Filter2: a1:0, b1:0, a2:0, b2:0, a0:32767



AT command	Description	AT interface configuration sharing	Factory-programmed value	Comment
			Filter2: 0, 0, 0, 0, 32767 Path 1: Filter1: -29322, -29141, 29322, 26240, 29322 Filter2: 29322, 29141, 29322, 26240, 29322 Path 3: Filter1: 0, 0, 0, 0, 32767 Filter2: 0, 0, 0, 0, 32767 Path 4: Filter1: 0, 0, 0, 0, 32767 Filter2: 0, 0, 0, 0, 32767	Path 1: • Filter1: a1:-29322, b1:-29141, a2:29322, b2:26240, a0:29322 • Filter2: a1:29322, b1:29141, a2:29322, b2:26240, a0:29322 Path 3: • Filter1: a1:0, b1:0, a2:0, b2:0, a0:32767 • Filter2: a1:0, b1:0, a2:0, b2:0, a0:32767 Path 4: • Filter1: a1:0, b1:0, a2:0, b2:0, a0:32767 • Filter2: a1:0, b1:0, a2:0, b2:0, a0:32767
			On SARA-G340 / SARA-G350 and LISA-U series, for all paths, all the filters are set to: 0, 0, 0, 0, 32767	On SARA-G340 / SARA-G350 and LISA-U series, for all paths, all the filters are set to: • a1:0, b1:0, a2:0, b2:0, a0:32767
+UHFP	Hand Free Parameters	Yes	On LEON-G1 series: Path 0: 0x01fd, 0x016e, 2200, 250, 3, 5, 150, 0, 0, 500, 4096, 16384, 16384 Path 1: 0x01fd, 0x016e, 2200, 250, 3, 5, 150, 0, 0, 500, 4096, 16384, 16384 Path 2: 0x01fd, 0x016e, 2200, 250, 8, 5, 150, 0, 0, 500, 4096, 16384, 16384	On LEON-G1 series: Path 0: • HF_algorithm_init:0x01fd, HF_Algorithm_Restart:0x016e, Step_Width:2200, LMS_Length:250, LMS_Offset:3, Block_Length:5, RXTX_Relation:150, Add_Atten:0, Min_Atten:0, Max_Atten:500, NR_sw_2:4096, NR_u_fak_0:16384, NR_u_fak:16384 Path 1: • HF_algorithm_init:0x01fd, HF_Algorithm_Restart:0x016e, Step_Width:2200, LMS_Length:250, LMS_Offset:3, Block_Length:5, RXTX_Relation:150, Add_Atten:0, Min_Atten:0, Max_Atten:500, NR_sw_2:4096, NR_u_fak_0:16384, NR_u_fak:16384 Path 2: • HF_algorithm_init:0x01fd, HF_Algorithm_Restart:0x016e, Step_Width:2200, LMS_Length:250, LMS_Offset:8, Block_Length:5, RXTX_Relation:150, Add_Atten:0, Min_Atten:0, Max_Atten:500, NR_sw_2:4096, NR_u_fak_0:16384, NR_u_fak:16384
			On SARA-G340 / SARA-G350 series: Path 0: 0x31fd,NA,NA,NA,NA,NA,NA,0,0,588,8192,16384,16384,2,100,100,100,0,0,0 Path 1: 0x31fd,NA,NA,NA,NA,NA,NA,0,0,588,8192,16384,16384,2,100,100,100,0,0,0 Path 2: 0x31fd,NA,NA,NA,NA,NA,NA,0,0,588,8192,16384,16384,2,100,100,100,0,0,0 Path 4:	On SARA-G340 / SARA-G350: Path 0: • HF_algorithm_init:0x31fd, HF_Algorithm_Restart:NA, Step_Width:NA, LMS_Length:NA, LMS_Offset:NA, Block_Length:NA, RXTX_Relation:NA, Add_Atten:0, Min_Atten:0, Max_Atten:588, NR_sw_2:8192, NR_u_fak_0:16384, NR_u_fak:16384, EC_block_length:2, EC_nr_coeff_real:100, EC_nr_coeff_complex1:100, EC_nr_coeff_complex2:100, EC_nr_coeff_complex3:0, EC_nr_coeff_complex4:0, EC_nr_coeff_complex5:0 Path 1: • HF_algorithm_init:0x31fd, HF_Algorithm_Restart:NA, Step_Width:NA, LMS_Length:NA, LMS_Offset:NA, Block_Length:NA, RXTX_Relation:NA, Add_Atten:0, Min_Atten:0, Max_Atten:588, NR_sw_2:8192, NR_u_fak_0:16384, NR_u_fak:16384, EC_block_length:2, EC_nr_coeff_real:100, EC_nr_coeff_complex1:100



AT command	Description	AT interface configuration sharing	Factory-programmed value	Comment
			0x31fd,NA,NA,NA,NA,NA,NA,0,0,588,8192,16384,16384,2,100,100,100,0,0,0	<p>0, EC_nr_coeff_complex2:100, EC_nr_coeff_complex3:0, EC_nr_coeff_complex4:0, EC_nr_coeff_complex5:0</p> <p>Path 2:</p> <ul style="list-style-type: none"> HF_algorithm_init:0x31fd, HF_Algorithm_Restart:NA, Step_Width:NA, LMS_Length:NA, LMS_Offset:NA, Block_Length:NA, RXTX_Relation:NA, Add_Atten:0, Min_Atten:0, Max_Atten:588, NR_sw_2:8192, NR_u_fak_0:16384, NR_u_fak:16384, EC_block_length:2, EC_nr_coeff_real:100, EC_nr_coeff_complex1:100, EC_nr_coeff_complex2:100, EC_nr_coeff_complex3:0, EC_nr_coeff_complex4:0, EC_nr_coeff_complex5:0 <p>Path 4:</p> <ul style="list-style-type: none"> HF_algorithm_init:0x31fd, HF_Algorithm_Restart:NA, Step_Width:NA, LMS_Length:NA, LMS_Offset:NA, Block_Length:NA, RXTX_Relation:NA, Add_Atten:0, Min_Atten:0, Max_Atten:588, NR_sw_2:8192, NR_u_fak_0:16384, NR_u_fak:16384, EC_block_length:2, EC_nr_coeff_real:100, EC_nr_coeff_complex1:100, EC_nr_coeff_complex2:100, EC_nr_coeff_complex3:0, EC_nr_coeff_complex4:0, EC_nr_coeff_complex5:0
			On LISA-U120 / LISA-U130 : Paths 0, 1, 2: 0x01fd, NA,NA,NA,NA,NA,NA,0,0,500,8192,7500,7500,2,100,100,60,60,60	<p>On LISA-U120 / LISA-U130: Paths 0, 1, 2:</p> <ul style="list-style-type: none"> HF_algorithm_init:0x01fd, HF_Algorithm_Restart:Not Available, Step_Width:Not Available, LMS_Length:Not Available, LMS_Offset:Not Available, Block_Length:Not Available, RXTX_Relation:Not Available, Add_Atten:0, Min_Atten:0, Max_Atten:500, NR_sw_2:8192, NR_u_fak_0:7500, NR_u_fak:7500, EC_block_length:2, EC_nr_coeff_real:100, EC_nr_coeff_complex1:100, EC_nr_coeff_complex2:100, EC_nr_coeff_complex3:60, EC_nr_coeff_complex4:60, EC_nr_coeff_complex5:60 <p>Path 4:</p> <ul style="list-style-type: none"> HF_algorithm_init:0x01fd, HF_Algorithm_Restart:Not Available, Step_Width:Not Available, LMS_Length:Not Available, LMS_Offset:Not Available, Block_Length:Not Available, RXTX_Relation:Not Available, Add_Atten:50, Min_Atten:100, Max_Atten:500, NR_sw_2:8192, NR_u_fak_0:7500, NR_u_fak:7500, EC_block_length:2, EC_nr_coeff_real:220, EC_nr_coeff_complex1:220, EC_nr_coeff_complex2:220, EC_nr_coeff_complex3:60, EC_nr_coeff_complex4:60, EC_nr_coeff_complex5:60
			On LISA-U2 series all the paths are set to: 0x0124, NA,NA,NA,NA,NA,NA,0,0,500,8192,7500,7500,2,100,100,100,60,60,60	<p>On LISA-U2 series all the paths are set to:</p> <ul style="list-style-type: none"> HF_algorithm_init:0x0124, HF_Algorithm_Restart:Not Available, Step_Width:Not Available, LMS_Length:Not Available, LMS_Offset:Not Available, Block_Length:Not Available, RXTX_Relation:Not Available, Add_Atten:0, Min_Atten:0, Max_Atten:500, NR_sw_2:8192, NR_u_fak_0:7500, NR_u_fak:7500, EC_block_length:2, EC_nr_coeff_real:100, EC_nr_coeff_complex1:100, EC_nr_coeff_complex2:100, EC_nr_coeff



AT command	Description	AT interface configuration sharing	Factory-programmed value	Comment
				complex3:60, EC_nr_coeff_complex4:60, EC_nr_coeff_complex5:60
+UMGC	Microphone Gain Control	Yes	<p>On LEON-G1 series:</p> <p>Path 0: 10,9384</p> <p>Path 1: 12,8192</p> <p>Path 2: 6,8192</p> <hr/> <p>On SARA-G340 / SARA-G350 series:</p> <p>Path 0:10,8192</p> <p>Path 1:10,8192</p> <p>Path 2:6,8192</p> <p>Path 4:10,8192</p> <hr/> <p>On LISA-U120 / LISA-U130 :</p> <p>Path 0:12,8192</p> <p>Path 1:12,8192</p> <p>Path 2:6,8192</p> <p>Path 4:13,8192</p> <hr/> <p>On LISA-U2 series all the paths are set to:</p> <p>NA,8192</p>	<p>On LEON-G1 series:</p> <p>Path 0:</p> <ul style="list-style-type: none"> Analog gain:10, Digital gain: 9384 <p>Path 1:</p> <ul style="list-style-type: none"> Analog gain:12, Digital gain: 8192 <p>Path 2:</p> <ul style="list-style-type: none"> Analog gain:6, Digital gain: 8192 <hr/> <p>On SARA-G340 / SARA-G350 series:</p> <p>Path 0:</p> <ul style="list-style-type: none"> Analog gain:10, Digital gain: 8192 <p>Path 1:</p> <ul style="list-style-type: none"> Analog gain:10, Digital gain: 8192 <p>Path 2:</p> <ul style="list-style-type: none"> Analog gain:6, Digital gain: 8192 <p>Path 4:</p> <ul style="list-style-type: none"> Analog gain:10, Digital gain: 8192 <hr/> <p>On LISA-U120 / LISA-U130:</p> <p>Path 0:</p> <ul style="list-style-type: none"> Analog gain:12, Digital gain: 8192 <p>Path 1:</p> <ul style="list-style-type: none"> Analog gain:12, Digital gain: 8192 <p>Path 2:</p> <ul style="list-style-type: none"> Analog gain:6, Digital gain: 8192 <p>Path 4:</p> <ul style="list-style-type: none"> Analog gain:13, Digital gain: 8192 <hr/> <p>On LISA-U2 series all the paths are set to:</p> <ul style="list-style-type: none"> Analog gain: NA, Digital gain: 8192
+UPSV	Power Saving (mode, timeout)	Yes	0	Power saving disabled
+USGC	Speaker Gain Control	Yes	<p>On LEON-G1 series:</p> <p>Path 0: 6, 1, 8192, 16384, 8192</p> <p>Path 1: 6, 0, 8192, 16384, 10240</p> <p>Path 3: 0, 6, 8192, 16384, 8191</p> <p>Path 4: 6, 6, 8192, 16384, 8191</p> <hr/> <p>On SARA-G340 / SARA-G350 series:</p>	<p>On LEON-G1 series:</p> <p>Path 0:</p> <ul style="list-style-type: none"> Speaker gain: 6, Headset gain: 1, speech and Tone Generator gain: 8192, Synthesizers gain: 16384, Speech gain: 8192 <p>Path 1:</p> <ul style="list-style-type: none"> Speaker gain:6, Headset gain:0, speech and Tone Generator gain: 8192, Synthesizers gain: 16384, Speech gain:10240 <p>Path 3:</p> <ul style="list-style-type: none"> Speaker gain: 0, Headset gain: 6, speech and Tone Generator gain: 8192, Synthesizers gain:16384, Speech gain: 8191 <p>Path 4:</p> <ul style="list-style-type: none"> Speaker gain: 6, Headset gain: 6, speech and Tone Generator gain: 8192, Synthesizers gain: 16384, Speech gain: 8191 <hr/> <p>On SARA-G340 / SARA-G350 series:</p> <p>Path 0:</p>



AT command	Description	AT interface configuration sharing	Factory-programmed value	Comment
			Path 0: 3, 3, 8192, 16384, 8192 Path 1: 3, 3, 8192, 16384, 8192 Path 3: 3, 3, 8192, 16384, 8192 Path 4: 5, 0, 8192, 16384, 8192	<ul style="list-style-type: none"> Speaker gain: 3, Headset gain: 3, speech and Tone Generator gain: 8192, Synthesizers gain: 16384, Speech gain: 8192 Path 1: Speaker gain:3, Headset gain:3, speech and Tone Generator gain: 8192, Synthesizers gain: 16384, Speech gain: 8192 Path 3: Speaker gain: 3, Headset gain: 3, speech and Tone Generator gain: 8192, Synthesizers gain: 16384, Speech gain: 8192 Path 4: Speaker gain: 5, Headset gain: 0, speech and Tone Generator gain: 8192, Synthesizers gain: 16384, Speech gain: 8192
			On LISA-U120 / LISA-U130 : Path 0: NA,0,8192,16384,NA Path 1: NA,1,8192,16384,NA Path 3: NA,0,8192,16384,NA Path 4: NA,3,8192,16384,NA	On LISA-U120 / LISA-U130: Path 0: <ul style="list-style-type: none"> Speaker gain: Not Available, Headset gain: 0, speech and Tone Generator gain: 8192, Synthesizers gain: 16384, Speech gain: Not Available Path 1: <ul style="list-style-type: none"> Speaker gain: Not Available, Headset gain: 1, speech and Tone Generator gain: 8192, Synthesizers gain: 16384, Speech gain: Not Available Path 3: <ul style="list-style-type: none"> Speaker gain: Not Available, Headset gain: 0, speech and Tone Generator gain: 8192, Synthesizers gain: 16384, Speech gain: Not Available Path 4: <ul style="list-style-type: none"> Speaker gain: Not Available, Headset gain: 3, speech and Tone Generator gain: 8192, Synthesizers gain: 16384, Speech gain: Not Available
			On LISA-U2 series all the paths are set to: NA,NA,8192,16384,NA	On LISA-U2 series all paths are set to: <ul style="list-style-type: none"> Speaker gain: Not Available, Headset gain: Not Available, speech and Tone Generator gain: 8192, Synthesizers gain: 16384, Speech gain: Not Available
+USTS	Smart Temperature Supervisor	Yes	0	Smart temperature URC disabled
+USTN	Sidetone	Yes	On LEON-G1 series: Path 0: 2249 Path 1: 2249 Path 3: 0 Path 4: 0	On LEON-G1 series: Path 0: <ul style="list-style-type: none"> Gain for side tone: 2249 Path 1: <ul style="list-style-type: none"> Gain for side tone: 2249 Path 3: <ul style="list-style-type: none"> Gain for side tone: 0 Path 4:



AT command	Description	AT interface configuration sharing	Factory-programmed value	Comment
				<ul style="list-style-type: none"> Gain for side tone: 0
			On LISA-U120 / LISA-U130 and SARA-G340 / SARA-G350: Path 0: 512 Path 1: 512 Path 3: 0 Path 4: 0	On LISA-U120 / LISA-U130 and SARA-G340 / SARA-G350: Path 0: <ul style="list-style-type: none"> Gain for side tone: 512 Path 1: <ul style="list-style-type: none"> Gain for side tone: 512 Path 3: <ul style="list-style-type: none"> Gain for side tone: 0 Path 4: <ul style="list-style-type: none"> Gain for side tone: 0
			On LISA-U2 series all paths are set to 512	On LISA-U2 series, for all paths: <ul style="list-style-type: none"> Gain for side tone: 512
+UUBF	Uplink Digital Filters (Uplink Biquad Filters)	Yes	On LEON-G1 series: Path 0: Filter1: -13915, 2249, 4377, -325, 23450 Filter2: 21682, -2312, 17984, -15517, 32767 Path 1: Filter1: -29322, -29141, 29322, 26240, 29322 Filter2: 29322, 29141, 29322, 26240, 29322 Path 2: Filter1: 0, 0, 0, 0, 32767 Filter2: 0, 0, 0, 0, 32767	On LEON-G1 series: Path 0: <ul style="list-style-type: none"> Filter1: a1:-13915, b1:2249, a2:4377, b2:-325, a0:23450 Filter2: a1:21682, b1:-2312, a2:17984, b2:-15517, a0:32767 Path 1: <ul style="list-style-type: none"> Filter1: a1:-29322, b1:-29141, a2:29322, b2:26240, a0:29322 Filter2: a1:29322, b1:29141, a2:29322, b2:26240, a0:29322 Path 2: <ul style="list-style-type: none"> Filter1: a1:0, b1:0, a2:0, b2:0, a0:32767 Filter2: a1:0, b1:0, a2:0, b2:0, a0:32767
			On SARA-G340 / SARA-G350 and LISA-U series, for all the paths, all filters are set to: 0, 0, 0, 0, 32767	On SARA-G340 / SARA-G350 and LISA-U series, for all the paths, all filters are set to: a1:0, b1:0, a2:0, b2:0, a0:32767
E	Echo status	No	1	Echo enabled
Q	Result code suppression	No	0	DCE transmits result codes
S0	Automatic answer	No	0	Automatic answering disabled
S2	Escape character selection	No	43	043 corresponds the '+' character
S3	Command line termination character	No	13	0x0d corresponds to the carriage return character
S4	Response formatting character	No	10	0x0a corresponds to the line feed character
S5	Command line editing character	No	8	008 corresponds to the backspace character
S7	Connection completion timeout	No	60	
V	DCE Response format	No	1	Verbose response text
X	Result code selection and call progress monitoring control	No	4	CONNECT <text> result code is given upon entering online data state; dial tone and busy detection are both enabled
+UTPB	Parity bit transmission over the air	Yes	0	Transmission of the parity bit over the air is disabled

B.2 Parameters stored in non volatile memory

The following table lists the AT commands which setting can be stored in the non volatile memory with their parameters and the factory-programmed values.

AT command	Description	Factory-programmed value	Comment
&Y	Designate a default reset profile	0	Profile 0 selected
+CALA	Alarm		No alarms are stored
+CALM	Alert sound mode	0	Mute disabled
+CCLK	Clock	04/01/01,00:00:00+00	
+CGDCONT	PDP Context definition	All contexts are undefined	Not available in LEON-G1 series The 3 PDP contexts are permanently stored when they are defined or deleted
+CGSMS	Select service for MO SMS messages	1	CSD service enabled
+CLVL	Speech volume level	80	80
+CPMS	Preferred message storage	"MT", "MT", "MT"	<mem1>, <mem2> and <mem3> are set to "MT"="ME"+"SM" with "ME" preferred
+CRSL	Ringer sound level	4	Ringer sound level: 4
+CSAS	Save settings	0	Profile 0 where to store the active message settings
+CSGT	Set greeting text	""	Greeting text is empty
+CTZU	Automatic Time Zone Update	0	Automatic time zone via NITZ disabled
+UCGCLASS	Changing the startup MS class	"B"	<class>="B"
+UCLASS	Device class setting	LEON-G1 / SARA-G3 series: 10 LISA-U1 / LISA-U2 series: 12, 12, 11, 11	LEON-G1 / SARA-G3 series: GPRS class 10 LISA-U1 / LISA-U2 series: GPRS class 12, EGPRS class 12, DTM GPRS class 11, DTM EGPRS class 11
+UCSD	Circuit Switched Data		Empty profile
+UDCONF=20	Steering of Roaming configuration	On LEON-G1 / SARA-G3 series: 0 On LISA-U2 series: 1	SoR is disabled. Not supported by LEON-G100-06S nor by SARA-G300 / SARA-G310 versions SoR enabled. Not supported by LISA-U1 series nor by LISA-U200-00S versions
+UDCONF=30	Speech codec configuration	On LEON-G1 / SARA-G3 series: 31 On LISA-U2 series: 3135	Not supported by LEON-G100-06S nor by SARA-G300 / SARA-G310 nor by LISA-U1 series and LISA-U200-00S version Not supported by LISA-U1 series and LISA-U200-00S version
+UDCONF=32	Connection type groups enable/disable	127	Not supported by LEON-G1 series or by LISA-U1 series or by LISA-U200-00S version
+UDCONF=40	User defined power reduction	2,2	MSPR GPRS and EDGE profile. Not supported by LEON-G1 / SARA-G3 series nor by LISA-U1 series and LISA-U200-00S version
+UDCONF=50	SIM hot insertion detection	0	Disabled
+UDCONF=61	Fast Dormancy configuration	2	All the <FD_mode> values are allowed
+UDCONF=66	IPv6 configuration	0	Disabled
+UDTMF	User setting for proactive DTMF tone generation	1	Proactive DTMF tone generation available
+UDYNDNS	Dynamic DNS	0,0,"", "", ""	Client disabled TZO.com Domain name empty Username empty Password empty
+UEXTDCONF	Automatic configuration of the Maxim MAX9860 audio codec	0 (disabled)	Not supported by LEON-G1 series and on LISA-U1 series or by LISA-U200-00S version



AT command	Description	Factory-programmed value	Comment
+UFDAC	Fast Dormancy Activation	5, 5	FD Delay Timer duration, FD Inhibit Timer duration
+UGAOF	AssistNow Offline configuration	"http://alp.u-blox.com/current_14d.alp",0,1,3	AssistNow Offline URL file: http://alp.u-blox.com/current_14d.alp One minute of timeout after a fail download Three attempts in case of failed download
+UGAOP	AssistNow Online configuration	"eval1-les.services.u-blox.com",46434,1000,0	Host name server: "eval1-les.services.u-blox.com" Server port: 46434 Expected network latency: 1000 ms AssistNow Online data downloaded at GPS receiver power up
+UGGGA	Get GPS fix data	0	NMEA \$GGA messages disabled
+UGGLL	Get geographic position	0	NMEA \$GLL messages disabled
+UGGSA	Get satellite information	0	NMEA \$GSA messages disabled
+UGGSV	Get number of GNSS satellites in view	0	NMEA \$GSV messages disabled
+UGPIOC	GPIO functionality setting	On LEON-G1 series: 8, 255, 3, 4, 5 On SARA-G340 / SARA-G350 series: 255, 3, 4, 5 On LISA-U1 series: 255, 3, 4, 5, 7 On LISA-U200-00S: 255, 255, 255, 255, 7, 255, 255, 255, 255 On LISA-U2 series (except LISA-U200-00S): 255, 3, 4, 5, 7, 12, 12, 12, 12, 13, 13, 13, 13, 13	On LEON-G1 series: Default setting for <gpio1>, <gpio2>, <gpio3>, <gpio4>, <gpio5> at the first power up. On SARA-G340 / SARA-G350 series: Default setting for <gpio1>, <gpio2>, <gpio3>, <gpio4> at the first power up. On LISA-U1 series: Default setting for <gpio1>, <gpio2>, <gpio3>, <gpio4>, <gpio5> at the first power up. On LISA-U200-00S: Default setting for <gpio1>, <gpio2>, <gpio3>, <gpio4>, <gpio5>, <gpio6>, <gpio7>, <gpio8>, <gpio9> at the first power up. On LISA-U2 series: Default setting for <gpio1>, <gpio2>, <gpio3>, <gpio4>, <gpio5>, <gpio6>, <gpio7>, <gpio8>, <gpio9>, <gpio10>, <gpio11>, <gpio12>, <gpio13>, <gpio14> at the first power up.
+UGPRF		0, 0, ""	No data flow on multiplexer, file and IP address IP port not defined Server address string not defined
+UGRMC	Get recommended minimum GNSS 0 data		NMEA \$RMC messages disabled
+UGSRV	Aiding server configuration	"cell-live1.services.u-blox.com", "cell-live2.services.u-blox.com", 14, 4, 1, 65, 0, 15	<ul style="list-style-type: none"> • Primary MGA server: "cell-live1.services.u-blox.com" • Secondary MGA server: "cell-live2.services.u-blox.com" • Number of days for validation of Offline data: 14 • Number of weeks for validation of Offline data: 4 • Resolution of offline data for MGA: 1 • Desired GNSS for the (offline) aiding: GPS and GLONASS



AT command	Description	Factory-programmed value	Comment		
			<ul style="list-style-type: none"> AssistNow Online data are downloaded at GNSS receiver power up All the desired data types for the (online) aiding are set 		
+UGVTG	Get course over ground and ground speed	0	NMEA \$VTG messages disabled		
+UGZDA	Get GPS Time and date	0	NMEA \$ZDA messages disabled		
+UHSDUPA	HSDPA/HSUPA mode configuration	1	HSDPA on		
		8	Category 8		
		1	HSUPA on		
		6	Category 6		
+I2S	I ² S Digital Interface Mode	On LEON-G1 series: 4,2,1	On LEON-G1 series: <ul style="list-style-type: none"> Mode: normal mode 4 Port: I2S is connected to I2Sy connection point CLK and WA active in continuous mode 		
		On SARA-G340 / SARA-G350: 1,1,0	On SARA-G340 / SARA-G350 series: <ul style="list-style-type: none"> Mode: normal mode 1 Port: I2S is connected to I2Sx connection point CLK and WA active in dynamic mode 		
		On LISA-U120 / LISA-U130: 0,1,0,0,0	On LISA-U120 / LISA-U130: <ul style="list-style-type: none"> Mode: PCM mode 0 Port: I2S is connected to I2Sx connection point CLK and WA active in dynamic mode Sample rate: 8 kHz Master/Slave mode: Master 		
		On LISA-U2 series: 1,1,0,3,0 1,3,0,3,0	On LISA-U2 series: I2S settings: <ul style="list-style-type: none"> Mode: PCM mode 1 Port: I2S is connected to I2Sx connection point CLK and WA active in dynamic mode Sample rate: 16 kHz Master/Slave mode: Master I2S1 settings: <ul style="list-style-type: none"> Mode: PCM mode 1 Port: I2S1 is connected to I2Sx connection point CLK and WA active in dynamic mode Sample rate: 16 kHz Master/Slave mode: Master 		
		+UIPCHGN	IP Change Notification	0	IP change notification disabled
		+ULOCCELL	Configure cellular location sensor (CellLocate®)	0	Normal mode enabled
		+ULOCGNSS	Configure GNSS sensor	15,0,3,7,0,0,0,0,0,0,0,0,0	Local aiding, AssistNow online, AssistNow offline, AssistNow autonomous enabled
					Power saving disabled
Minimum number of satellites for navigation: 3					
Minimum satellite signal level for navigation: 7					
Disabled initial Fix must be 3D flag					
			Static Hold Mode: 0		



AT command	Description	Factory-programmed value	Comment
			SBAS disabled
			Jamming indicator disabled
			Antenna settings unknown
			Broadband jamming detection threshold: 0 dB
			Continuous wave jamming detection threshold: 0 dB
+UMCLK	Master Clock Control	0	CODEC_CLK mode setting (<mclk_mode>): clock out pin from LISA module (input for audio codec) is set as three state with pull down resistor.
		0	Setting of dynamic of the application mode (<enabling_mode>): <mclk_mode> setting is applied to CODEC_CLK pin only when audio path is active. After audio path is disabled (i.e. a call is hang up) CODEC_CLK is disabled too
+UNVMMCC	MCC Update Table		Empty table
+UNVMPLMN	PLMN Info List		Empty table
+UPSD	Packet Switched Data		Empty profile
+URAT	Selection of Radio Access technology	1,2	<ul style="list-style-type: none"> Radio Access technology: GSM/UMTS Dual mode RAT UMTS
+URING	RING line handling	0	Feature disabled (RING line is only asserted on incoming call and incoming SMS)
+URNG	Ringtone selection	0	Melody 0
+URXDIV	RX Diversity	1	3G Rx Diversity disabled
	DARP Phase	3	DARP Phase 2 always on
+USOAO	Socket Always On	0,0	Feature disable
		1,0	PSD profile: 0
		2,0	Client Mode
		3,""	Empty
		4,2000	Default port: 2000
		5,6	TCP socket
		20+i,""	Empty
+USPM	Audio Path mode setting	On LEON-G1 series: 0,0,1,1,0	On LEON-G1 series: <ul style="list-style-type: none"> Speech audio output path: Handset microphone Speech audio input path: Normal earpiece Alert sound on Loudspeaker Headset indication: considered VMIC is switched On /Off
		On SARA-G340 / SARA-G350 series: 0,0,0,0,0	On SARA-G340 / SARA-G350 series: <ul style="list-style-type: none"> Speech audio output path: Handset microphone Speech audio input path: Normal earpiece Alert sound on main downlink path (Mono headset earpiece) Headset indication: not considered VMIC is switched On /Off
		On LISA-U1 series: 1,1,0,0,2	On LISA-U1 series: <ul style="list-style-type: none"> Speech audio output path: Headset microphone

AT command	Description	Factory-programmed value	Comment
			<ul style="list-style-type: none"> Speech audio input path: Mono headset earpiece Alert sound on main downlink path (Mono headset earpiece) Headset indication: not considered VMIC is always switched Off
		On LISA-U2 series: 1,1,0,0,2	On LISA-U2 series: <ul style="list-style-type: none"> Speech audio output path: Downlink path 1 via I2S Speech audio input path: Uplink path 1 via I2S Alert sound on main downlink path (Downlink path 1 via I2S) Headset indication: not considered VMIC is always switched Off

B.3 Saving AT commands configuration

The following procedure can be used to store the AT commands configuration for the AT commands listed in [Appendix B.1](#) and [Appendix B.2](#).

- Write the run-time configuration of the AT commands listed in [Appendix B.1](#) to the RAM profile mirror with the *AT&W* command (e.g. *AT&W0*)
- Confirm that the boot loading is performed with the desired parameter profile (e.g. profile 0 if the parameter save was performed with *AT&W0*; use *AT&Y0* to select this)
- Since the permanently saving of NVM content is achieved by a low priority process, the time depends on all the other activities as network procedures, call management, and so on. To be sure to save suddenly the run-time configuration of the commands listed in [Appendix B.2](#), it is advisable to use *+CPWROFF* or *+CFUN=15* or *+CFUN=16*. If the *+CPWROFF* has been issued the module, perform a reboot of the device

B.4 Estimated command response time

After having sent a command to a u-blox cellular module, the time to obtain a resulting result code depends on the SIM and the network. It is possible to have an immediate response if the command does not interact with either the network or the SIM.

The following table reports the maximum time to get the result code for the AT commands. The commands are grouped by categories.

Category	Estimated maximum time to get response	Commands
Call control and supplementary services	< 20 s Up to 7 min	A, H, +CHLD, +CHUP, +CNAP, +COLP, +COLR, +CSVM +VTS
Power off	< 40 s	+CPWROFF
Network commands	Up to 3 min (<1 s for prompt ">" when present) Up to 1 s < 5 s < 40 s	D, D>, DL, +CCFC, +CCWA, +CFUN, +CLCK, +CGATT, +CGDATA, +COPS, +CPMS, +CLIP, +CLIR, +CMGL, +CMGR, +CMGS, +CMSS, +CPWD, +CTFR, +CUSD, +UCGOPS, +UCMGL, +UCMGP, +UCMGR, +UCMGS, +UCSDA, +UPSDA +UDOPN +UCELLINFO +UEONS
SIM management	< 10 s	+CRES, +CAOC, +CACM, +CMM, +CNUM, +CPIN, +CPOL, +CPUC, +CRSM, +CMGW, +CR, +CSCA, +CSCB, +CSMP, +UCMGW
SIM toolkit	< 20 s	+SATD, +SATE, +SATR, +STKENV, +STKTR
GNSS commands	< 10 s (except +UGPS for which timeout is according to the performed operation)	+UGAOS, +UGGGA, +UGGLL, +UGGSA, +UGGSV, +UGPS, +UGRMC, +UGTMR, +UGUBX, +UGVTG, +UGZDA, +ULOC
GPIO commands	< 10 s	+UGPIOC, +UGPIOR, +UGPIOV

Category	Estimated maximum time to get response	Commands
Internet suite (TCP/IP, DNS, FTP, HTTP, SMTP)	< 10 s (except URC)	+UFTP, +UFTPC, +UHHTTP, +UHHTPC, +UHHTPER, +USMTPM, +USMTPC, +USOCL, +USODL, +USOLI, +USORD, +USORF, +USOST, +USOWR
	< 20 s	+USOCO
	< 30 s (except URC)	+UDNSRN
Phonebook commands	< 35 s	+CPBF, +CPBR, +CPBS, +CPBW
PDP context activation	< 150 s	+CGACT, +UPSDA
PDP context deactivation	< 40 s	+CGACT, +UPSDA
Delete all the SMSes	< 55 s	+CMGD
Send an SMS	< 150 s	+CMGS, +CMSS
New message acknowledgement to MT	< 150 s	+CNMA

B.5 Multiple AT command interfaces

u-blox cellular modules support multiple AT command interfaces, that means a certain number of virtual or physical channels that work as described in [Chapter 1.1](#).

Each interface maintains an own run-time AT commands configuration (AT command profile); this means that the AT command profile is different among the interfaces and therefore the AT commands configuration for the commands belonging to the profile can be different among the interfaces.

At the module start-up, since there is only a set of the profiles (not one for each interface), all the interfaces are configured in the same way (AT commands configuration for the commands in the profile is the same for all the interfaces). Subsequently, each interface can change its run-time AT profile (stored in RAM). The commands [AT&W](#), [AT&V](#) manage this run-time AT commands configuration for the interface where they are issued.

The USB interface implements multiple AT command interfaces. Unlike what happens for the other physical interfaces (e.g. UART, SPI), the AT command interfaces that run on the USB interface only exists as long as the USB interface connects the module with the DTE. As a result, if the USB connection between the module and the DTE is interrupted (e.g. by USB cable removal), all the AT command interfaces running on it are destroyed. This has two main consequences:

- Any data connection (both circuit switched and packet switched) established over an AT command interface associated to the USB interface is released.
- As already explained in [Appendix B.1](#), whenever the USB connection between the module and the DTE is re-established, the AT command interfaces running on it are created, and for each of these interfaces the AT command profile is reloaded from NVM and applied.



The reload of the AT command profile from the NVM also results in the re-application of the [+UPSV](#) setting, which is a shared "AT interface configuration". This must be kept in mind, since the change could have impacts on the communication over the UART interface.

As mentioned in [Chapter 1.1](#), generally there is not difference in the execution of an AT command among the interfaces. But, there are some exceptions due to interface restrictions. In particular, the differences relate to AT commands that configure the DCE-DTE interface.

[Table 32](#) provides the major differences.

AT command	UART	Multiplexer	USB (where available)	SPI (where available)
AT&K	Effective	When it returns OK (the configuration is allowed), it is effective	When it returns OK (the configuration is allowed), it is not effective (only change the value in the AT command profile)	When it returns OK (the configuration is allowed), it is not effective (only change the value in the AT command profile)
AT\Q	Effective	When it returns OK (the configuration is allowed), it is effective	When it returns OK (the configuration is allowed), it is not effective (only change the value in the AT command profile)	When it returns OK (the configuration is allowed), it is not effective (only change the value in the AT command profile)



AT command	UART	Multiplexer	USB (where available)	SPI (where available)
AT+IFC	Effective	When it returns OK (the configuration is allowed), it is effective	When it returns OK (the configuration is allowed), it is not effective (only change the value in the AT command profile)	When it returns OK (the configuration is allowed), it is not effective (only change the value in the AT command profile)
AT+IPR	Effective	Returns OK, but it is not effective (only change the value in the AT command profile)	Returns OK, but it is not effective (only change the value in the AT command profile)	Returns OK, but it is not effective (only change the value in the AT command profile)
AT+ICF	Effective	Returns OK, but it is not effective (only change the value in the AT command profile)	Returns OK, but it is not effective (only change the value in the AT command profile)	Returns OK, but it is not effective (only change the value in the AT command profile)
AT+UPSV	Effective	Returns OK, but it changes UART setting	Returns OK, but it changes UART setting	Returns OK, but it changes UART setting

Table 32: Interface comparison

C Appendix: UDP Direct Link workflow

C.1 Data from the IP network to the external port

When an UDP data packet is received from the network, its payload is forwarded through the external port as soon as possible (according to the HW flow control, if any).

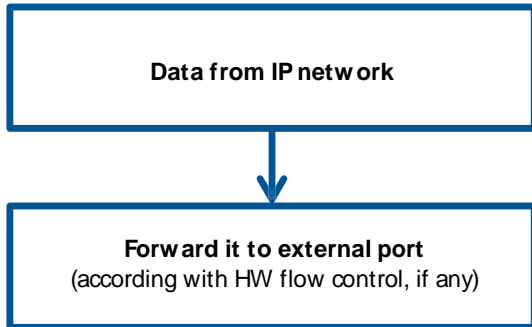

C.2 Data from the external port to the IP network

When some data comes from the external port, there are 2 parameters involved:

1. The UDP DL packet size (factory-programmed: 1024 bytes; valid range 100-1472)
2. The UDP DL sending timer delay (factory-programmed: 1000 ms; valid range 100-120000)

Both parameters are specific for each socket and could be modified by the user. These values are not saved into the NVM and if not specified, the factory-programmed values are used.

There are 3 different cases that may occur while receiving data from the external port in UDP DL mode:

1. The received data from the external port is equal to the UDP DL packet size
2. The received data from the external port is more than the UDP DL packet size
3. The received data from the external port is less than UDP DL packet size

Case 1: the received data is immediately sent to the network

Case 2: the amount of data till UDP DL packet size is immediately sent to the network, the remaining data is saved into an intermediate buffer.

Case 3: the received data is saved into an intermediate buffer and sent to the network when the UDP DL sending timer expires. The timer is reset (it restarts the countdown) every time new data is received from the external port, this means that the data will be sent to the network after N ms (default 1000 ms) since the last received byte.



The data sent from the serial port is not echoed to the sender.



The configuration of UDP DL packet size and UDP DL sending timer are NOT saved in NVM.

The following diagram shows how the events of external data input and sending timer expire are handled.

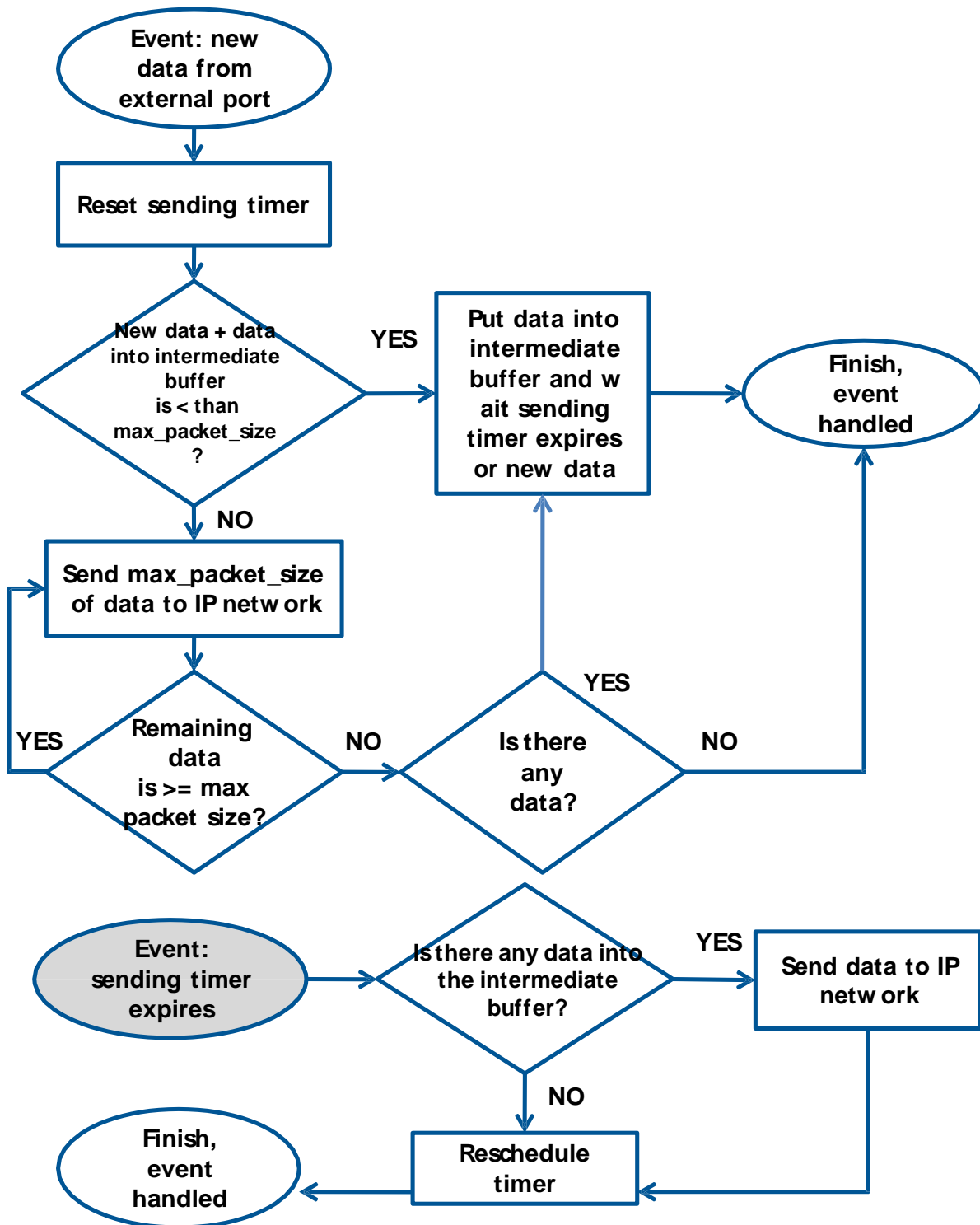

D Appendix: Glossary

3GPP	3rd Generation Partnership Project
ADC	Analog to Digital Converter
AleC	Automatically Initiated eCall
ADN	Abbreviated Dialing Numbers
AMR	Adaptive Multi Rate
APN	Access Point Name
ASCII	American Standard Code for Information Interchange
AT	AT Command Interpreter Software Subsystem, or attention
BL	Black List
BSD	Berkley Standard Distribution
CB	Cell Broadcast
CBM	Cell Broadcast Message
CLI	Calling Line Identification
CLIP	Calling Line Identification Presentation
CLIR	Calling Line Identification Restriction
COLP	Connected Line Identification Presentation
COLR	Connected Line Identification Restriction
CM	Connection Management
CPHS	Common PCN Handset Specification
CR	Carriage Return
CS	Circuit Switch
CSD	Circuit-Switched Data
CTS	Clear To Send
CUG	Closed User Group
DA	Destination Address
DARP	Downlink Advanced Receiver Performance
DCD	Data Carrier Detect
DCE	Data Communication Equipment
DCM	Data Connection Management
DNS	Domain Name Server
DSR	DSC transponder response
DTE, TE	Data Terminal Equipment
DTMF	Dual Tone Multi Frequency
DTR	Data Terminal Ready
DUT	Device Under Test
eCall	Emergency Call
EEP	EEPROM Emulation Parameters
EF _{PLMNwAcT}	Elementary File "User controlled PLMN Selector with Access Technology"
eIM	eCall In-band Modem
EONS	Enhanced Operator Name from SIM-files EF _{OP} and EF _{PNN}
EPD	Escape Prompt Delay
ETSI	European Telecommunications Standards Institute
FDN	Fixed Dialling Number
FOAT	Firmware Over AT
FOTA	Firmware Over The Air
FS	File System
FTP	File Transfer Protocol
FW	Firmware
FWINSTALL	Firmware Install
GPIO	General Purpose Input Output
GPRS	General Packet Radio Service
GPS	Global Positioning System
GSM	Global System for Mobile Communications



HDLC	High Level Data Link Control
HPLMN	Home PLMN
HTTP	HyperText Transfer Protocol
I	Information
I ² C	Inter-Integrated Circuit
I ² S	Inter IC Sound or Integrated Interchip Sound
ICCID	Integrated Circuit Card ID
ICMP	Internet Control Message Protocol
ICP	Inter Processor Communication
IMEI	International Mobile Equipment Identity
IMSI	International Mobile Station Identity
InBM	In-Band Modem (generic)
IP	Internet Protocol
IRA	International Reference Alphabet
IRC	Intermediate Result Code
ISDN	Integrated Services Digital Network
ISP	Internet Service Provider
IVS	In-Vehicle System (eCall related)
L3	Layer 3
LCP	Link Control Protocol
LF	Line Feed
M2M	Machine-To-Machine
MCC	Mobile Country Code
ME	Mobile Equipment
MeC	Manually Initiated eCall
MMI	Man Machine Interface
MN	Mobile Network Software Subsystem
MNC	Mobile Network Code
MO	Mobile Originated
MS	Mobile Station
MSD	Minimum Set of Data (eCall related)
MSIN	Mobile Subscriber Identification Number
MSISDN	Mobile Systems International Subscriber Identity Number
MSPR	Multi-Slot Power Reduction
MT	Mobile Terminated
MWI	Message Waiting Indication
NITZ	Network Identity and Time Zone
NVM	Non-Volatile Memory
OLCM	On Line Commands Mode
PAD	Packet Assembler/Disassembler
PCN	Personal Communication Network
PDP	Packet Data Protocol
PDU	Protocol Data Unit
PIN	Personal Identification Number
PLMN	Public Land Mobile Network
PPP	Point-to-Point Protocol
PSAP	Public Safety Answering Point (eCall related)
PSD	Packet-Switched Data
PUK	Personal Unblocking Key
QoS	Quality of Service
RAM	Random Access Memory
RDI	Restricted Digital Information
RFU	Reserved for Future Use
RI	Ring Indicator
RTC	Real Time Clock
RTP	Real-time Transport Protocol



RTS	Request To Send
Rx	Receiver
SAP	SIM Access Profile
SC	Service Centre
SI	SIM Application Part Software Subsystem
SIP	Session Initiation Protocol
SIM	Subscriber Identity Module
SMS	Short Message Service
SMSC	Short Message Service Center
SMTP	Simple Mail Transfer Protocol
SoR	Steering of Roaming
TA	Terminal Adaptor
TCP	Transfer Control Protocol
TE	Terminal Equipment
TFT	Traffic Flow Template
TP	Transfer layer Protocol
Tx	Transmitter
TZ	Time Zone
UCS2	Universal Character Set
UDI	Unrestricted Digital Information
UDP	User Datagram Protocol
UI	Unnumbered Information
UICC	Universal Integrated Circuit Card
UIH	Unnumbered Information with header Check
URC	Unsolicited Result Code
USIM	UMTS Subscriber Identity Module
UUS1	User-to-User Signalling Supplementary Service 1