



PET-7026/ET-7026 User Manual

Version 1.0.1 beta1, April 2010

Written by Liam Lin

Edited by Anna Huang

Warranty

All products manufactured by ICP DAS are under warranty regarding defective materials for a period of one year, beginning from the date of delivery to the original purchaser.

Warning

ICP DAS assumes no liability for any damage resulting from the use of this product. ICP DAS reserves the right to change this manual at any time without notice. The information furnished by ICP DAS is believed to be accurate and reliable. However, no responsibility is assumed by ICP DAS for its use, not for any infringements of patents or other rights of third parties resulting from its use.

Copyright

Copyright © 2009 by ICP DAS Co., Ltd. All rights are reserved.

Trademark

The names used for identification only may be registered trademarks of their respective companies.

Contact US

If you have any problem, please feel free to contact us.
You can count on us for quick response.

Email: service@icpdas.com

Table of Contents

Chapter 1. Introduction	6
1.1. Features	8
1.2. Specifications	11
1.2.1. System Specifications	11
1.2.2. I/O Specifications	13
1.2.3. Wiring Specifications.....	15
1.3. Overview	16
1.3.1. Front Panel	16
1.3.2. Back Panel.....	17
1.4. Dimensions	18
1.5. Companion CD.....	19
Chapter 2. Getting Started.....	20
2.1. Mounting the Hardware	20
2.2. Configuring the Boot Mode.....	22
2.3. Connecting to Network, PC and Power	23
2.4. Installing the MiniOS7 Utility.....	24
2.5. Using MiniOS7 Utility to Assign a new IP	25
2.6. Enabling Adobe Flash Player in Browser	29
Chapter 3. Web Applications.....	31
3.1. Overview	34
3.2. Configuration.....	36
3.2.1. Network Settings	37
3.2.2. Basic Settings	41
3.2.3. Module I/O Settings.....	50
3.3. Authentication.....	51
3.3.1. Account Management	52

3.3.2. Accessible IP Settings	55
3.4. Web HMI	58
3.4.1. Web HMI	59
3.4.2. Web Edit	60
3.5. Pair Connection.....	68
3.6. More Information	69
Chapter 4. Modbus Applications	70
4.1. What is Modbus TCP/IP?	71
4.2. Modbus Message Structure	72
4.2.1. Address	73
4.2.2. Function Codes.....	74
4.2.3. Data Field.....	74
4.2.4. Error Check.....	74
4.3. Modbus Register Map	75
4.3.1. Read/Write Coils (0xxxx).....	75
4.3.2. Read/Write Discrete Outputs or Coils (1xxxx).....	79
4.3.3. Read Input Registers (3xxxx).....	80
4.3.4. Read/Write Output or Holding Registers (4xxxx).....	83
Chapter 5. MiniOS7 Utility Tool	87
5.1. Establishing a Connection.....	87
5.2. Exchanging the Protocol (TCP/IP to UDP)	90
5.3. Updating the PET-7000/ET-7000 OS	92
5.4. Uploading the PET-7000/ET-7000 Firmware.....	97
Chapter 6. External Tools and Tasks	102
6.1. LabVIEW	102
6.2. OPC Server.....	103
6.3. SCADA.....	104
6.3.1. InduSoft.....	105

6.3.2. Citect.....	106
6.3.3. iFix	107
Appendix A. Frame Ground	108
Appendix B. Node Information Area.....	109
Appendix C. Modbus Application Notes	110
C.1. Dual Watchdog	110
C.2. Power ON Value	111
C.3. Safe Value	112
C.4. AI High/Low Alarm	113
C.5. AI High/Low Latch.....	118
Appendix D. Troubleshooting	122

Chapter 1. Introduction

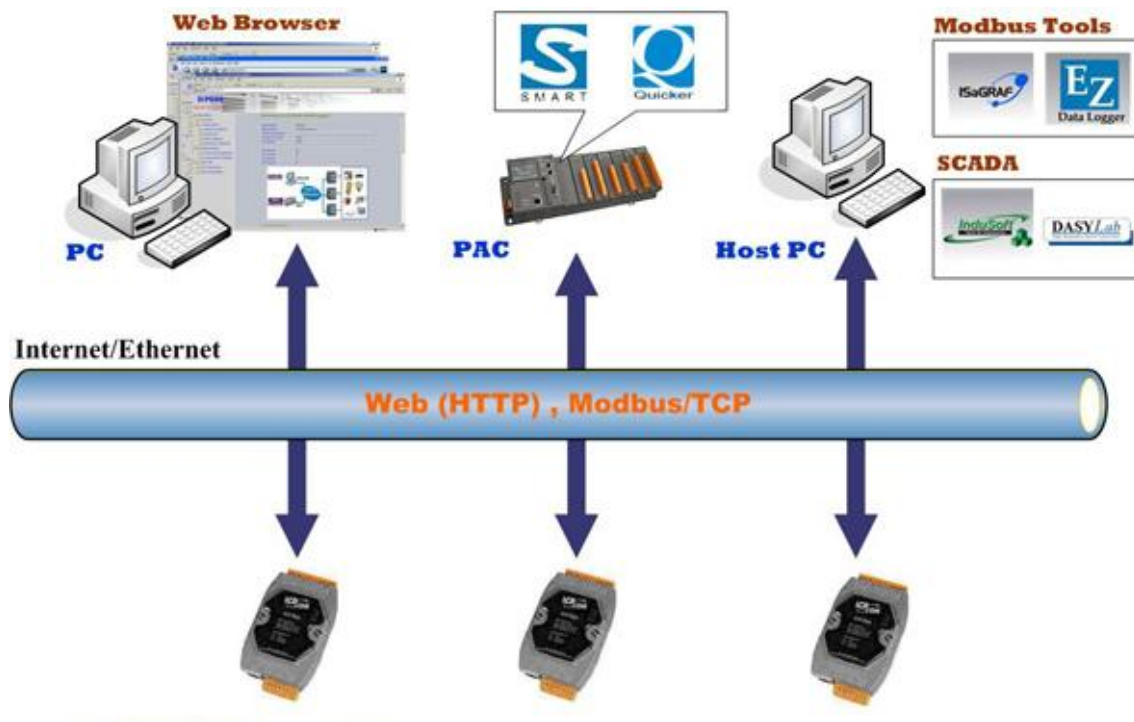

The PET-7026/ET-7026, a web-based Ethernet I/O module, features a built-in web server, which allows configuration, I/O monitoring and I/O control by simply using a regular web browser. Besides, with the web HMI function, no more programming or HTML skills are needed; creating dynamic and attractive web pages for I/O monitoring and I/O control would be fun to engineers ever after. The ET-7026 offers easily and safely access for users from anytime and anywhere! In addition, ET-7026 also supports Modbus/TCP protocol that makes perfect integration to SCADA software.

The PET-7026/ET-7026 is a multi-function module, there are 6-channel analog inputs, 2-channel analog output, 2-channel digital inputs and 2-channel digital outputs module. It provides programmable input range on all analog inputs (+/-500mV, +/-1V, +/-5V, +/-10V, +/-20mA, 0 ~ 20mA and 4 ~ 20mA), analog outputs are 12 bit with +/-5V, +/-10V, 0 ~ 20mA and 4 ~ 20mA and digital output can be set alarm output. Each analog input is allowed to configure an individual range and has 240Vrms high over voltage protection. Jumper selectable for voltage or current inputs/outputs.

The features of the PET-7026 differ from the ET-7026

The PET-7026 has integrated Power-over-Ethernet (PoE), it allows power and data to be carried over a single Ethernet cable, so a device can operate solely from the power it receives through the data cable. This innovation allows greater flexibility in office design, higher efficiency in systems design, and faster turnaround time in set-up and implementation. The PET-7026 feature true IEEE 802.3af-compliant (classification, Class 1) Power over Ethernet (PoE) using both Ethernet pairs (Category 5 Ethernet cable). The PET-7026 can receive power from an auxiliary power sources like AC adapters and battery in addition to the PoE enabled network. This is a desirable feature when the total system power requirements exceed the PSE's load capacity. Furthermore, with the auxiliary power option, the PET-7026 can be used in a standard Ethernet (non-PoE) system.

1.1. Features

► Built in Web Server

Each PET-7000/ET-7000 module has a built-in web server that allows users to easily configure, monitor and control the module from a remote location using a regular web browser.



► Web HMI

The Web HMI function allows the users to create dynamic and attractive web pages to monitor and control the I/O points. Users can upload specific I/O layout pictures (bmp, jpg, gif format) and define a description for each I/O point. No HTML or Java skills are needed to create the web pages.

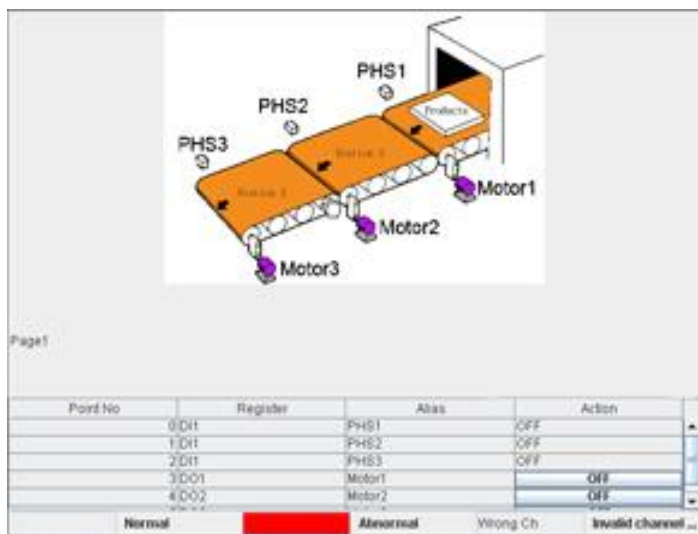

➤ **Communication Security**

Account and password are required when logging into the PET-7000/ET-7000 web server. An IP address filter is also included, which can be used to allow or deny connections with specific IP addresses.

➤ **Modbus Protocol**

The Modbus/TCP slave function on the Ethernet port can be used to provide data to remote SCADA software.

➤ **Built-in Multi-function I/O**

All Digital Output modules provide:

Power on value (On boot up, the DO status is set to the Power-on value)

Safe value (If Modbus/TCP communication is lost for a certain period, the DO status will be set to the user defined safe value)

All Digital Input modules provide:

High/Low latched status

DI channels can also be used as DI status and 32-bit low speed (100Hz) counters.

➤ **All-in-one Module**

Various I/O components are mixed with multiple channels in a single module, which provides the most cost effective I/O usage and enhances performance of the I/O operations

➤ **Automatic MDI / MDI-X Crossover for Plug-and-play**

RJ-45 port supports automatic MDI/MDI-x that can automatically detect the type of connection to the Ethernet device without requiring special straight or crossover cables.

► Built-in Dual Watchdog

The Dual Watchdog consists of a Module Watchdog and a Host Watchdog.

Module Watchdog is a built-in hardware circuit that can be used to monitor the operation of the module and will reset the CPU module if a failure occurs in the hardware or the software.

Host Watchdog is a software function that can be used to monitor the operating status of the host, and is used to prevent network communication problems or host failures.

► Ventilated Housing Designed to Operate Between -25 °C to +75 °C

PET-7000/ET-7000 is housed in a plastic-based shell/case with a column-like ventilator that helps to cool the working environment inside the shell/case and allows PET-7000/ET-7000 to operate at temperatures ranging from -25 °C to +75 °C.

► I/O Pair Connection

This function is used to create a DI to DO pair through the Ethernet. Once the configuration is completed, PET-7000/ET-7000 module can to continuously poll the status of remote DI device using the Modbus/TCP protocol and then write to local DO channels in the background.

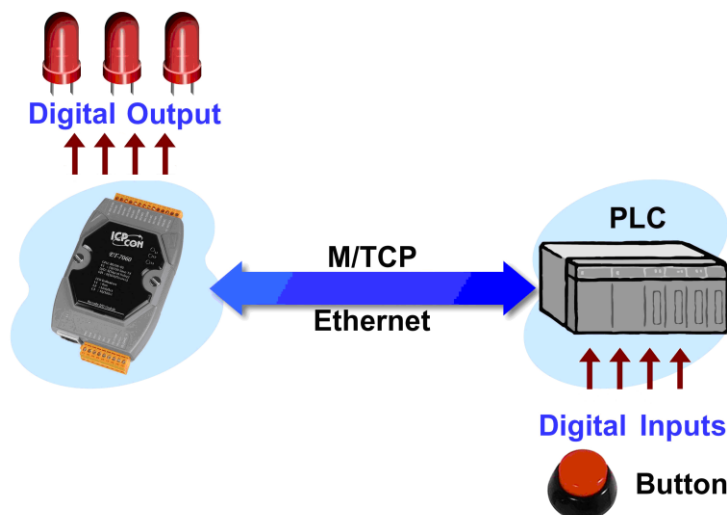

1.2. Specifications

1.2.1. System Specifications

System	
CPU	80186 CPU (80 MHz)
SRAM	512 KB
Flash Memory	512 KB
EEPROM	16 KB
Dual Watchdog	Yes
Communication	
Ethernet Port	10/100 Base-TX (With Link, Activity LED Indicator) Auto MDI/MDI-X connection
Isolation	
Ethernet	-
AI, AO, DI and DO	2500 V _{DC}
LED Display	
PoE (for PET-7026 only)	PoE on
L1	Run indicator
L2	Link/Act indicator
L3	10/100M indicator
Power Requirements (for PET-7026 only)	
IEEE 802.3af	Class 1
Required Supply Voltage	Powered by Power-Over-Ethernet (PoE) or auxiliary power + 12 ~ + 48 VDC (non-regulated)
LED Indicator	Yes
Power Consumption	0.12A @ 24 VDC Max.
Power Requirements (for ET-7026 only)	
Protection	Power reverse polarity protection
Required Supply Voltage	+10 V _{DC} ~ +30 V _{DC} (non-regulated)
Power Consumption	0.10 A @ 24 V _{DC} Max.

Mechanical	
Dimensions (W x H x D)	72 mm x 123 mm x 35 mm
Installation	DIN Rail or Wall mounting
Environment	
Operating Temperature	-25 °C ~ +75 °C
Storage Temperature	-30 °C ~ +80 °C
Humidity	5 ~ 90 % RH, non-condensing

1.2.2. I/O Specifications

Analog Input		
Input Channels		6
Input Type		+/- 500 mV, +/- 1 V, +/- 5 V, +/- 10 V +0 mA ~ +20 mA, +/- 20 mA, +4 mA ~ +20 mA (Jumper selectable)
Resolution	Normal Mode	16-bit
	Fast Mode	12-bit
Sampling Rate	Normal Mode	10 Samples/Sec.
	Fast Mode	50 Samples/Sec. (Total)
Accuracy	Normal Mode	+/- 0.1 %
	Fast Mode	+/- 0.5 % or better
Bandwidth	Normal Mode	15.7 Hz
	Fast Mode	78.7 Hz
Zero Drift		+/- 20 $\mu\text{V}/^\circ\text{C}$
Span Drift		+/- 25 ppm/ $^\circ\text{C}$
Input Impedance		2 M Ω
Common Mode Rejection		86 dB Min.
Normal Mode Rejection		100 dB
Oversoltage Protection		240 Vrms
ESD Protection		+/- 4 kV (Contact for each channel) +/-8 kV air for random point
EFT Protection		+/- 4 kV for power
Analog Output		
Output Channels		2
Output Type		+0 V _{DC} ~ +5 V _{DC} , +/-5 V _{DC} , +0 V _{DC} ~ +10 V _{DC} , +/-10 V _{DC} , +0 mA ~ +20 mA, +/- 20 mA, +4 mA ~ +20 mA (Jumper selectable)
Resolution		12-bit
Accuracy		+/- 0.1 % of PSR
Voltage Output Capability		10 V @ 20 mA
Current Load Resistance		500 Ohms

Power-up and Safe Value	Yes	
Open Wire for Current Output	4 mA ~ 20 mA	
Digital Input		
Input Type	2 (Dry + Wet)	
Dry Contact (Source)	On Voltage Level	Close to GND
	Off Voltage Level	Open
	Effective Distance for Dry Contact	500M Max.
Wet Contact (Sink/Source)	On Voltage Level	+1 V _{DC} Max.
	Off Voltage Level	+3.5 V _{DC} ~ +30 V _{DC}
Counter	Channels	2
	Max. Counts	32-bit (4294967295)
	Max. Input Frequency	100 Hz
	Min. Pulse Width	5 ms
Digital Output		
Output Channels	2 (Sink)	
Output Type	Isolated Open Collector	
Max. Load Current	700 mA/Channel	
Load Voltage	+5 V _{DC} ~ +50 V _{DC}	
External Power Reversed Protection and Short Circuit Protection	Yes	
Over-Temperature Protection	Yes, 150 ^ C	
Current Limited Protection	1.1 A	

1.2.3. Wiring Specifications

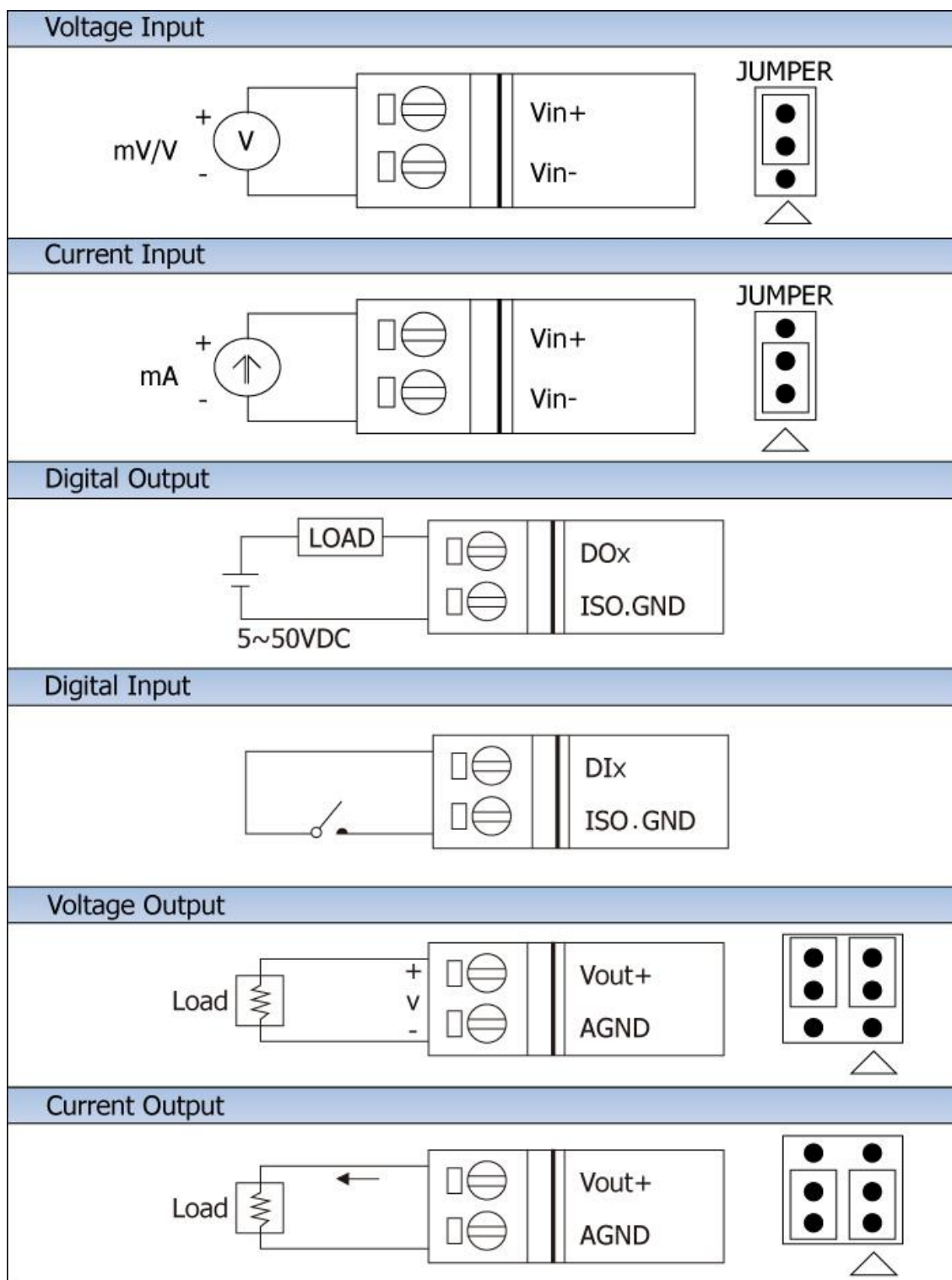

1.3. Overview

1.3.1. Front Panel

The PET-7000/ET-7000 front panel contains the Ethernet port, connectors and LEDs.

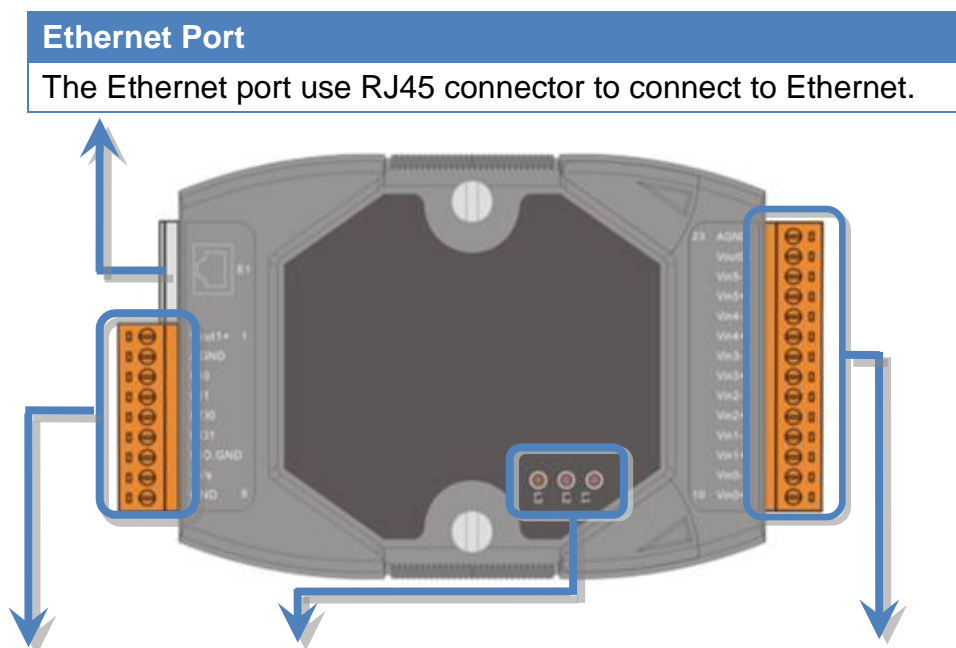

Ethernet Port

The Ethernet port use RJ45 connector to connect to Ethernet.

J1 Connector	
Pin #	Function
1	Vout1+
2	AGND
3	DI0
4	DI1
5	DO0
6	DO1
7	ISO.GND
8	+Vs
9	GND

L1 LED Indicator

LED Status	Function
Flashing	The PET-7000/ET-7000 is turned on and is ready for use.

L2 LED indicator

LED Status	Function
On	Ethernet link detected.
Off	No Ethernet link detected.
Flashing	Ethernet packet received.

L3 Indicator

LED Status	Function
On	Speed 10 Mbps
Off	Speed 100 Mbps

J2 Connector

Pin #	Function
10	AGND
11	Vout0+
12	Vin5-
13	Vin5+
14	Vin4-
15	Vin4+
16	Vin3-
17	Vin3+
18	Vin2-
19	Vin2+
20	Vin1-
21	Vin1+
22	Vin0-
23	Vin0+

1.3.2. Back Panel

The PET-7000/ET-7000 back panel contains the frame ground and Init/Normal switch.

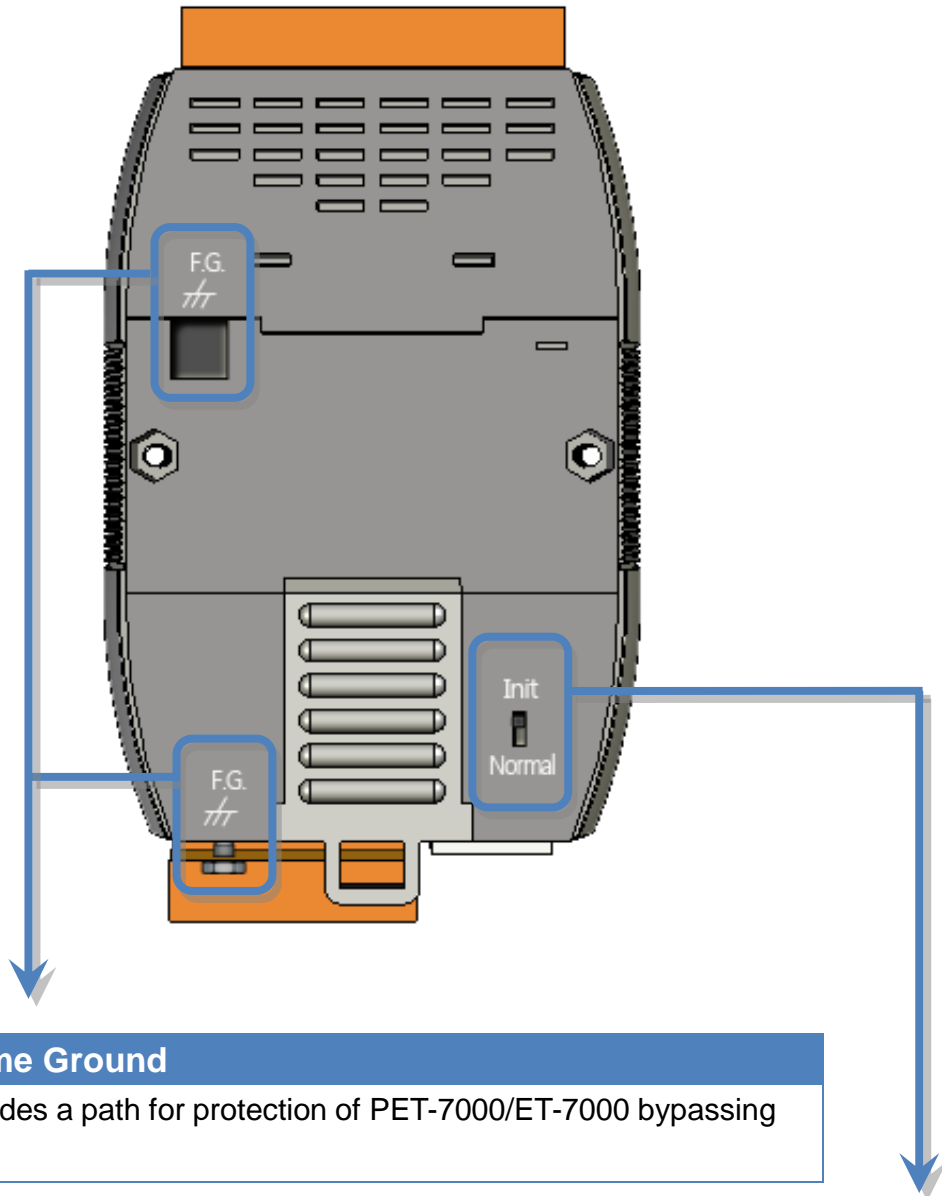

Frame Ground
Provides a path for protection of PET-7000/ET-7000 bypassing ESD.

Init/Normal Switch
Allows you to select the operating mode.

1.4. Dimensions

All dimensions are in millimeters.

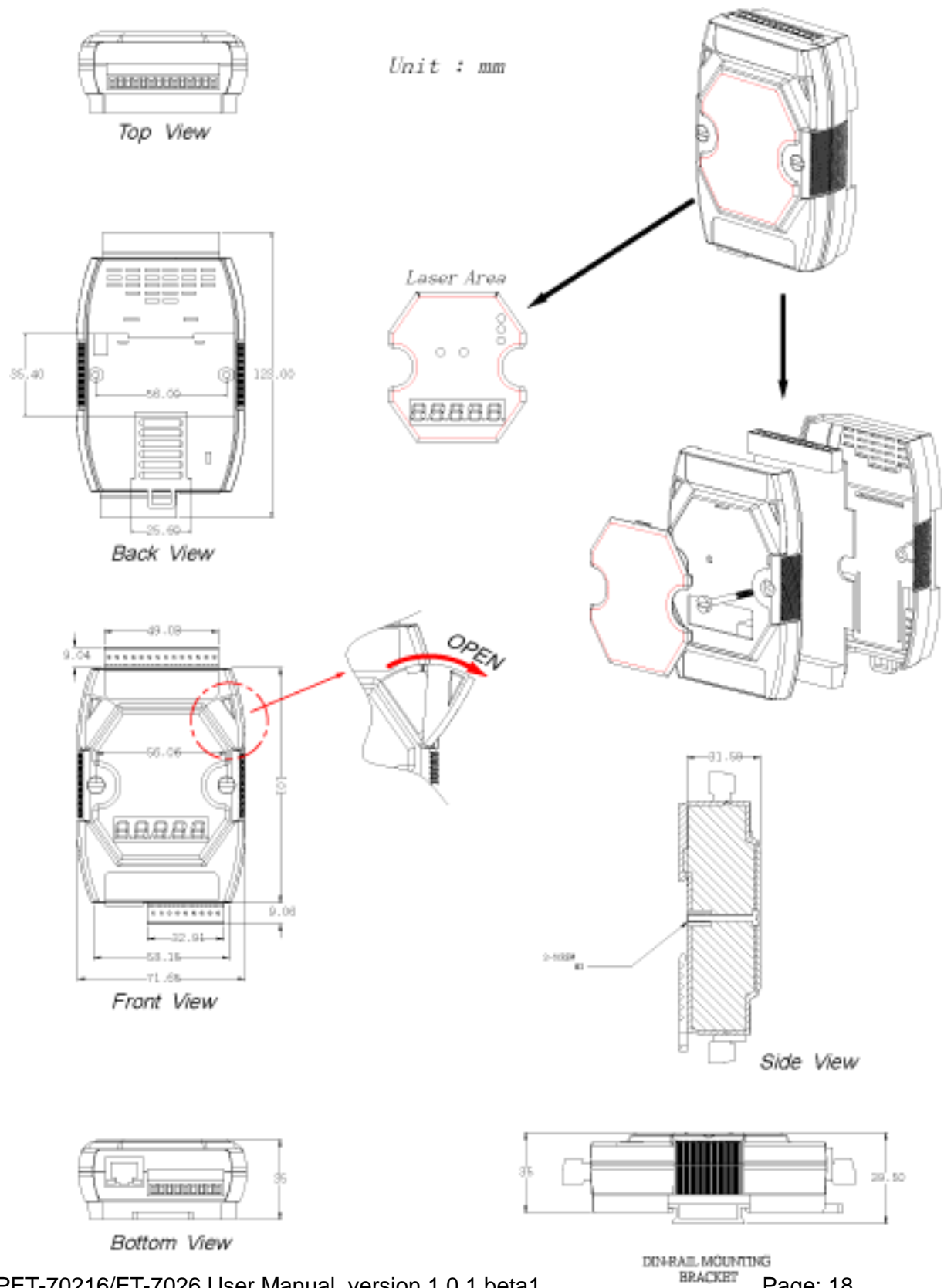

1.5. Companion CD

This package comes with a CD that provides drivers, software utility, all of the required documentations..., etc. All of them are listed below.

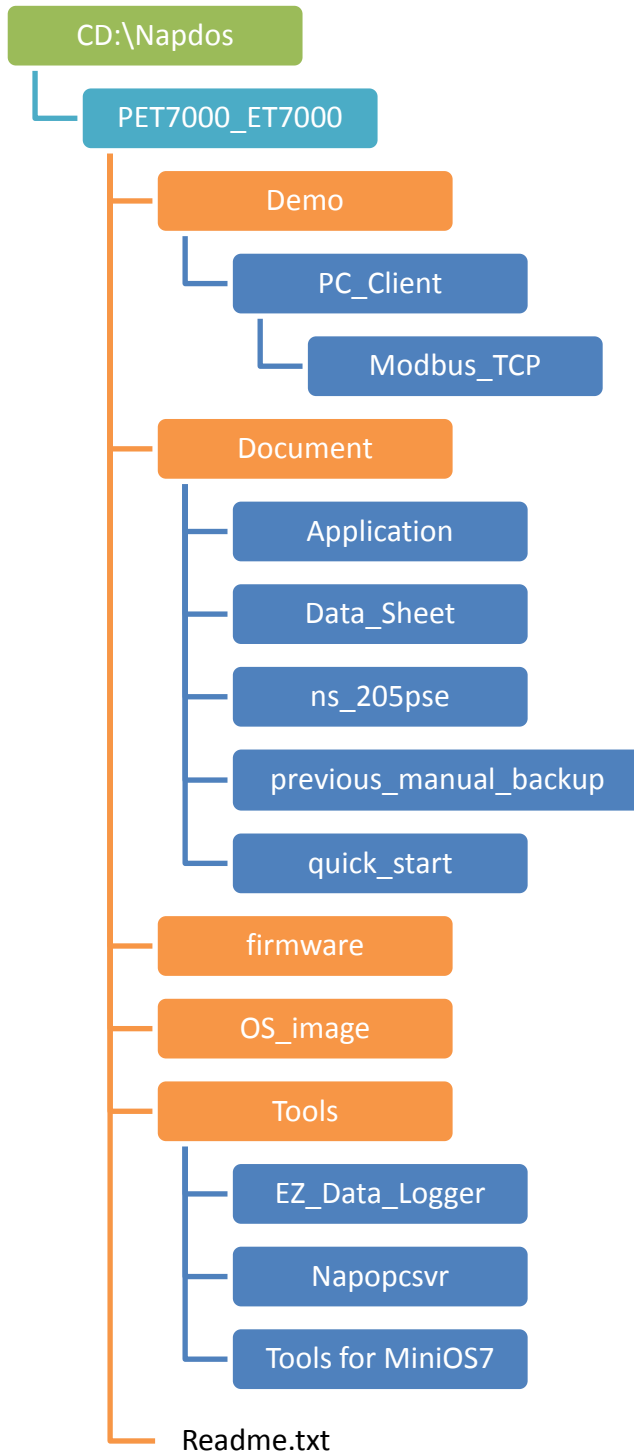

Chapter 2. Getting Started

If you are a new user, begin with this chapter, it includes a guided tour that provides a basic overview of installing, configuring and using the PET-7000/ET-7000.

2.1. Mounting the Hardware

The PET-7000/ET-7000 can be mounted with the bottom of the chassis on the DIN rail, the wall or piggyback.

► DIN Rail mounting

The PET-7000/ET-7000 has simple rail clips for mounting reliably on a standard 35 mm DIN rail.

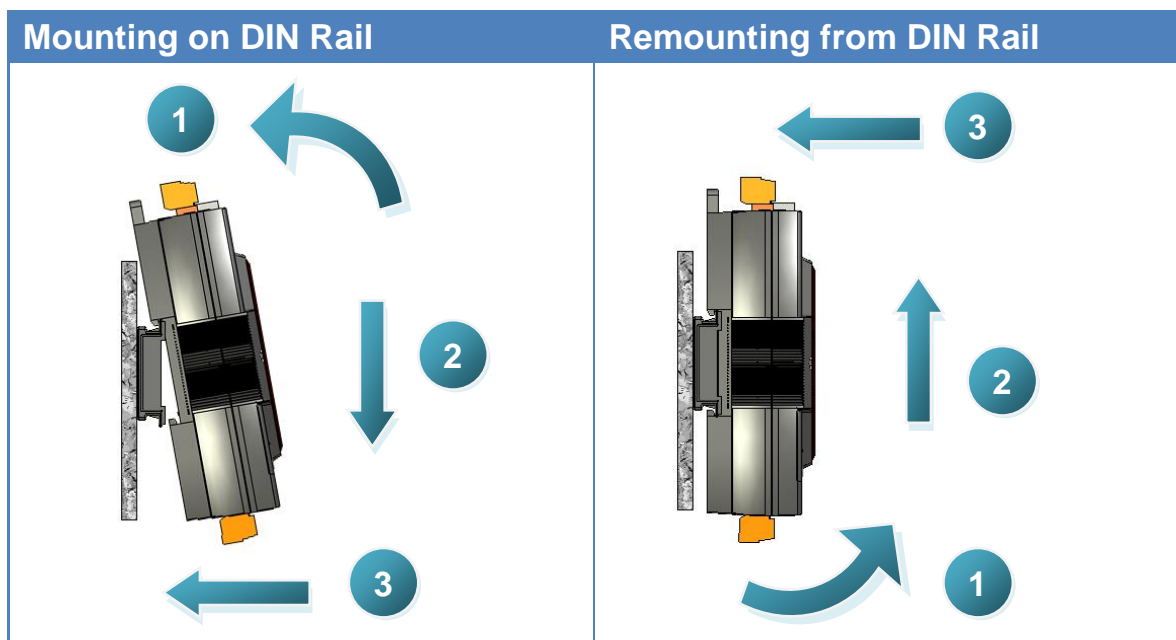
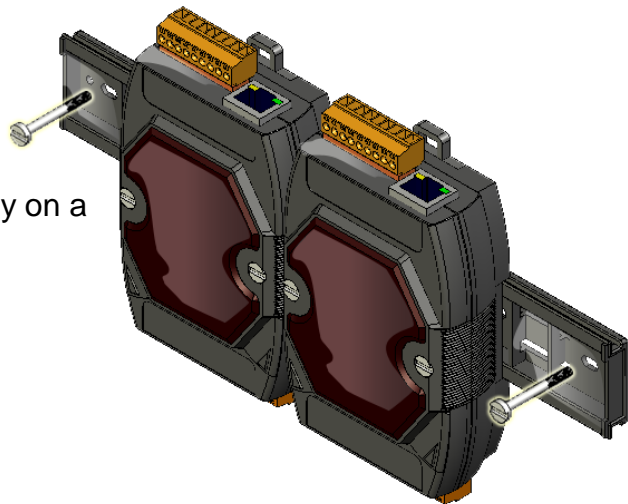

Din Rail Mountable Model

Three Din rail mountable models are available to mount a variety of ICP DAS devices. Each is made of stainless steel and has a ground wire at the end.

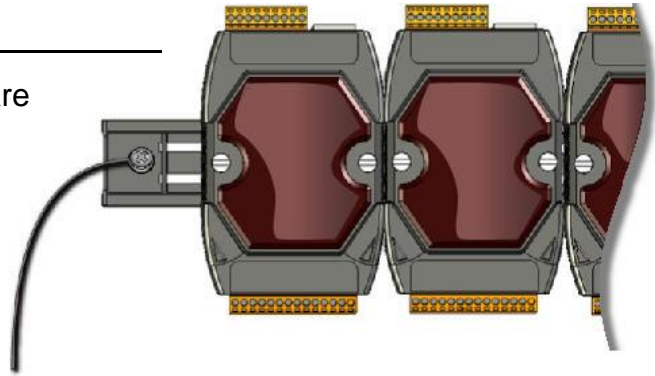

Part number	Maximum number of modules	Dimensions
DRS-125	2	125 mm x 35 mm
DRS-240	3	240 mm x 35 mm
DRS-360	5	360 mm x 35 mm

► Piggyback Mounting

The PET-7000/ET-7000 has two holes on both sides for piggyback mounting

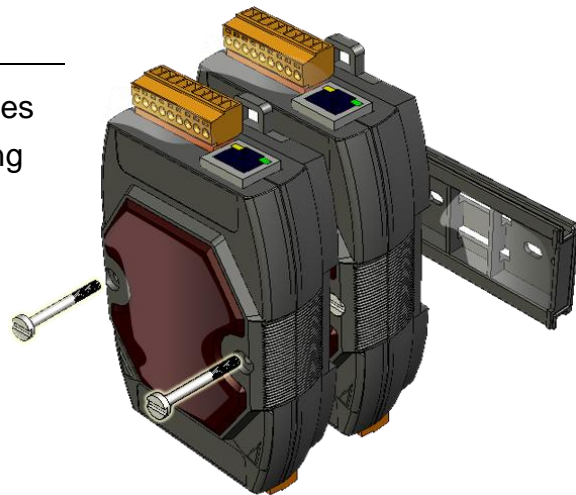

2.2. Configuring the Boot Mode

The PET-7000/ET-7000 has two operating modes that can be determined by the switch mechanism on the chassis.

► Init Mode

Init mode is a way to use MiniOS7 configuration mode.

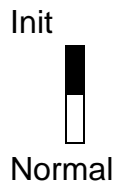

► Normal Mode

Normal mode is the default mode of operation and the one you will use most of the time. Use this mode for more tasks and configurations. Programs also are executed in this mode.

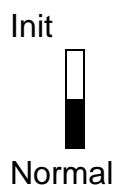

Normal mode is the default mode of operation and the one you will use most of the time. Use this mode for more tasks and configurations. Programs also are executed in this mode.

Move the switch to the Normal position after the update is complete

2.3. Connecting to Network, PC and Power

The PET-7000/ET-7000 is equipped with an RJ-45 Ethernet port for connection to an Ethernet hub/switch and PC

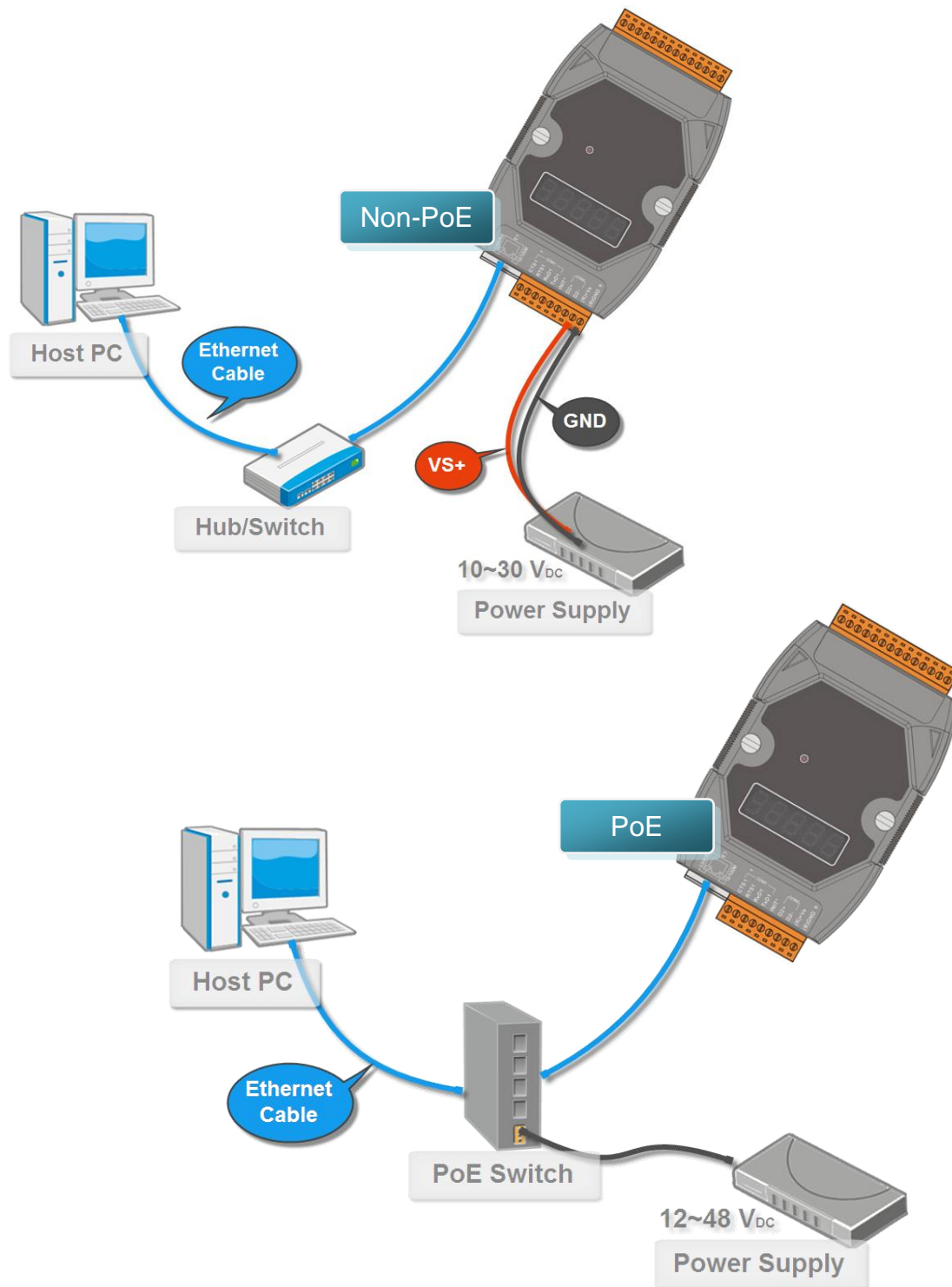

2.4. Installing the MiniOS7 Utility

The MiniOS7 Utility is a useful tool that provides a quick and easy way to update OS image or firmware, configure Ethernet settings, and download files to PET-7000/ET-7000 from PC.

Step 1: Get the MiniOS7 Utility tool

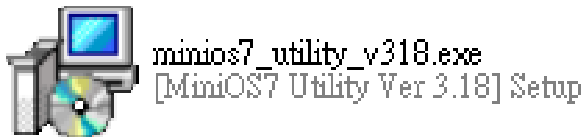

The MiniOS7 Utility can be obtained from companion CD or our FTP site:
CD:\Napedos\minios7\utility\minios7_utility\
ftp://ftp.icpdas.com/pub/cd/8000cd/napdos/minios7/utility/minios7_utility/

Step 2: Follow the prompts to complete the installation

After the installation has been completed, there will be a new short-cut for MiniOS7 Utility on the desktop.

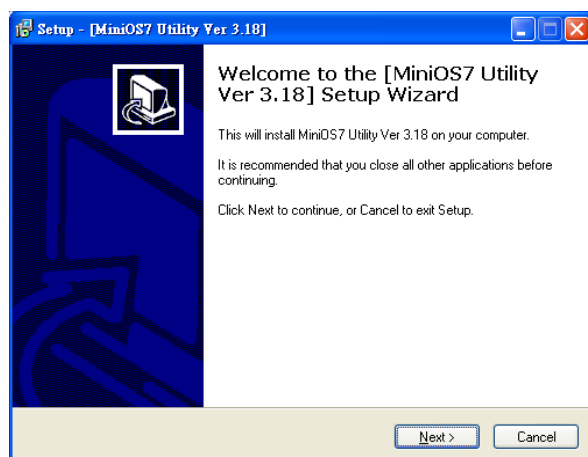

2.5. Using MiniOS7 Utility to Assign a new IP

The PET-7000/ET-7000 are web-based devices, which comes with a default IP address, therefore, you must first assign a new IP address to the PET-7000/ET-7000.

The factory default IP settings are as follows:

Item	Default
IP Address	192.168.255.1
Subnet Mask	255.255.0.0
Gateway	192.168.0.1

Step 1: Run the MiniOS7 Utility



Double-click the MiniOS7 Utility shortcut on your desktop.

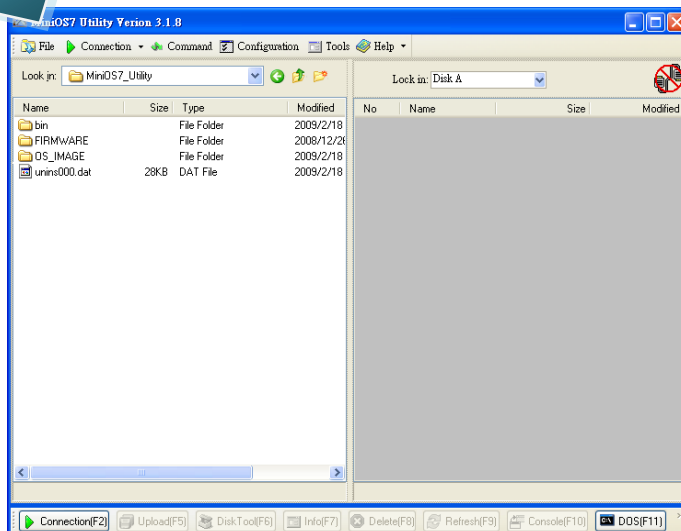

Step 2: Press “F12” or choose “Search” from the “Connection” menu

After pressing F12 or choosing Search from Connection menu, that will search all of the MiniOS7 modules on your network.

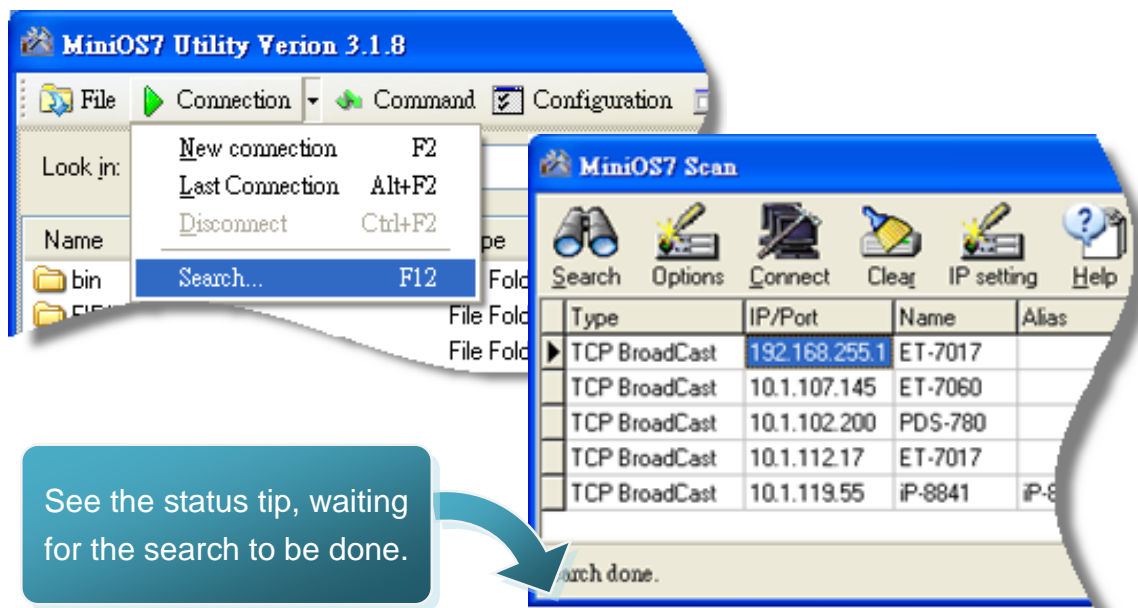

Step 3: Choose the field “192.168.255.1” and then choose “IP setting” from the toolbar

Choose default value “192.168.255.1” for fields in the list, and then choose IP setting from the toolbar.

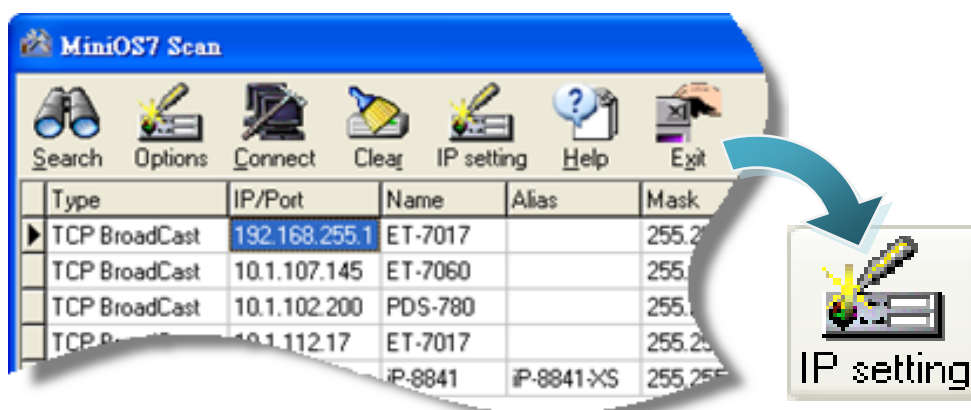

Step 4: Assign a new IP address and then choose “Set” button

You can manually assign an IP address or use DHCP to dynamically assign IP addresses

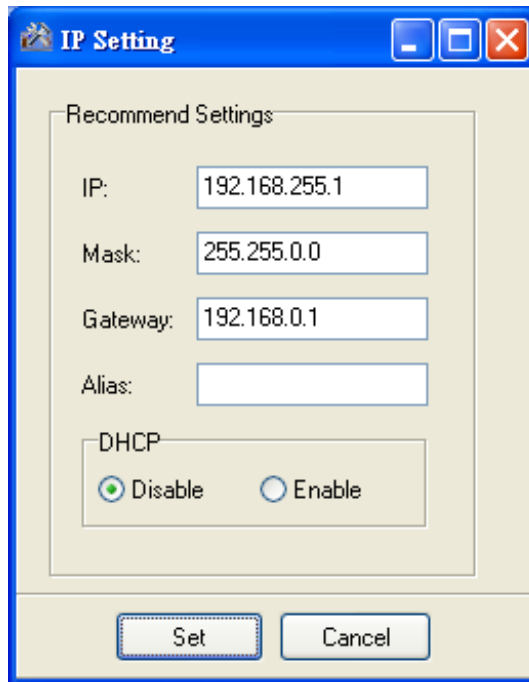

Step 5: Choose “Yes” button

After completing the settings, the Confirm dialog box will appear, and then choose the Yes button to exit the procedure.

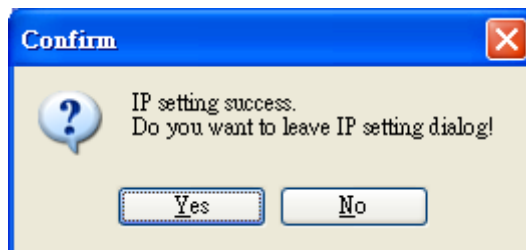

Step 6: Reboot the module and then press “F12” or choose “Search” from the “Connection” menu to check the IP setting

After completing the settings, you can reboot the module and then using MiniOS7 to search module again for making sure that your IP settings are correct.

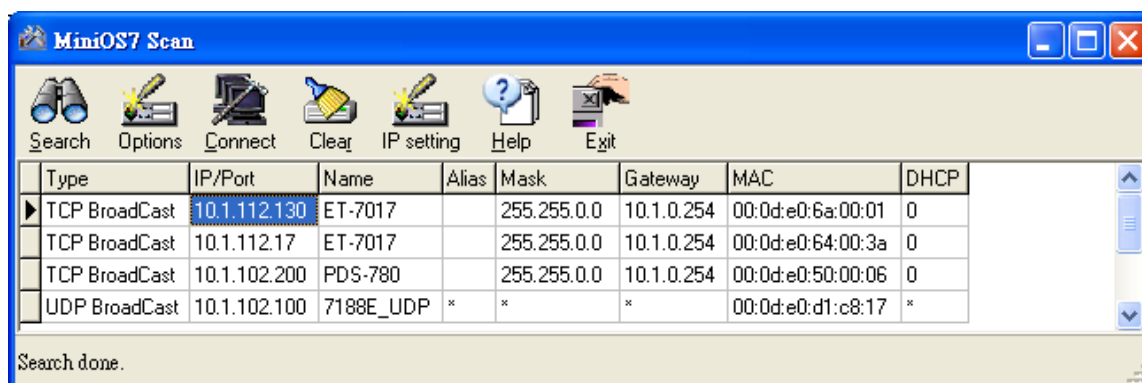
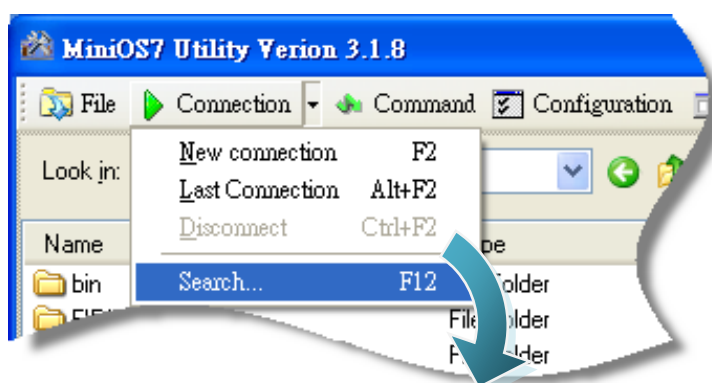

2.6. Enabling Adobe Flash Player in Browser

Your browser must support the Adobe Flash Player in order to view the PET-7000/ET-7000 web site.

If you do not have it installed, please follow the instructions below.

Step 1: Go to the Adobe Flash Player Download Center



The Adobe Flash Player Download Center:

<http://get.adobe.com/flashplayer/>

Step 2: Follow the prompts to download the installation file

Click the Agree and install now button and follow the instructions to download the installation file



Install Adobe Flash Player

Adobe Flash Player version 10.0.32.18 1.87 MB
Windows, Internet Explorer
Different operating system or browser?

[Learn more](#) | [System requirements](#) | [Distribute Flash Player](#) | [Installation instructions](#)

Also install:

Free Google Toolbar (optional) 1.8 MB

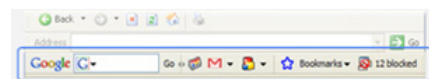

Search Google from any web page, block pop-ups

[Learn more](#) | [Privacy policy](#) | [License](#)

You must close all other browser windows before installing.
Download time estimate: 2 minutes @ 56K modem

 **Agree and install now**

Total:
3.67MB

By clicking the "Agree and install now" button, you agree to the [Software License Agreement](#) and the [Google Toolbar Terms of Service](#). Adobe may use the Adobe Download Manager to seamlessly install your software.

Step 3: Verify that the Adobe Flash Player has been installed

You can verify that it has been installed correctly by clicking the link below.

<http://get.adobe.com/flashplayer/completion/dlm/>

Welcome huang | Your account | Sign out | | Contact | United States (Change)

Solutions | Products | Support | Communities | Company | Downloads | Store

Home / Downloads /

Adobe Flash Player

 **Adobe Flash Player successfully installed.**

When you see the installation completion movie above and text below, your installation was successful. The installation should only take a minute or two on a 56k modem.

If Adobe Flash Player fails to install, please visit the [Adobe Flash Player Support Center](#) for help troubleshooting the issue.

Note:

Installation Complete
Version 10,0,32,18
installed successfully

DID YOU KNOW?



Now you can use Flash to educate, train, and inform in minutes, not months.
[Learn more >](#)

FLASH PLAYER HOME

FLASH PLAYER HELP

- [System requirements](#)
- [Flash Player Support Center](#)
- [FAQ](#)

MORE DOWNLOADS

-  [Get ADOBE® READER®](#)
-  [Get ADOBE® SHOCKWAVE® PLAYER](#)

FLASH CONTENT

- [Site of the Day](#)
- [Showcase](#)
- [Games](#)
- [Animation](#)

Chapter 3. Web Applications

The PET-7000/ET-7000 contains an advanced web configuration system that provides users with access PET-7000/ET-7000 applications through a standard web browser.

Logging in to the PET-7000/ET-7000 Web site

You can log in to the PET-7000/ET-7000 web site from any computer that has Internet access.

Step 1: Open a browser

In several browsers, Mozilla Firefox and Internet Explorer are both reliable and popular internet browsers.

Step 2: Type the URL address of the PET-7000/ET-7000

If you haven't changed the default IP address of the PET-7000/ET-7000, please refer section "2.5. Using MiniOS7 Utility to Assign a new IP" to configure it.

Step 3: Fill out the User name and Password

After entering the IP address, the login dialog box will appear and prompt you to enter your username and password.

The factory default user name and password are as follows:

Item	Default
User name	Admin
Password	Admin



Step 4: Welcome to PET-7000/ET-7000 web site

After logging into the PET-7000/ET-7000 web site, the welcome page will appear.

ICP DAS
<http://www.icpdas.com>

Welcome to the ET-7000 Web configuration page

Model Name	ET-7026
MAC Address	00:0d:e0:64:00:23
Module Information	
Firmware Version	V101 (Aug 23 2009)
OS Version	V22a (Jun 4 2009)
DI channels	2
DO channels	2
AI channels	6
AO channels	2

The diagram illustrates the system architecture, showing a central 'TCP/IP Ethernet' hub connected to 'SCADA', 'IPC/PC', 'Web Browser', and 'PAC' components. Various sensors and actuators are also depicted.

- Main Menu
 - Overview
 - Configuration
 - Network Settings
 - Basic Settings
 - Module I/O Settings
 - Authentication
 - Account Management
 - Accessible IP Settings
 - Web HMI
 - Web HMI
 - Web Edit
 - Pair Connection
 - More Information

This site serves several functions. You can easily access these functions through the menu on the left side.

The Overview of the Main menu provides a brief introduction and explanation of this site.

3.1. Overview

The Overview links to the welcome page that determines two message body parts.

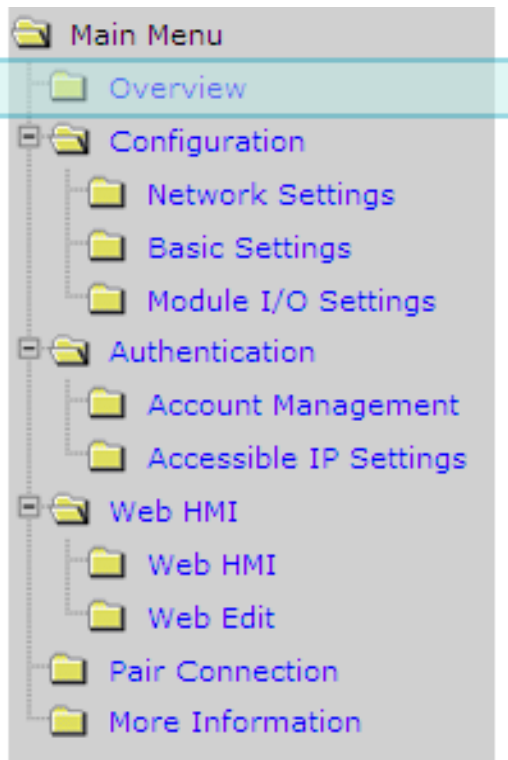

The first part of this page provides basic information about the PET-7000/ET-7000 hardware and software.

Welcome to the ET-7000 Web configuration page

Model Name	ET-7026
MAC Address	00:0d:e0:64:00:23
Module Information	
Firmware Version	V101 (Aug 23 2009)
OS Version	V22a (Jun 4 2009)
DI channels	2
DO channels	2
AI channels	6
AO channels	2

The second part of this page provides a brief introduction of this web site.

General Description

The ET-7000 series is a selection of cost effective, high performance 10/100 Mbps I/O modules designed for remote data collection and remote Ethernet application control. Each ET-7000 module includes its own internal Ethernet configuration, Modbus TCP/IP port and web port, with a built-in simple HMI that makes configuration and access easy, together with an I/O LED display to indicate the current transmission status.

The ET-7000 supports Modbus/TCP without the need for any extra programming. It can be easily connected to most SCADA software such as Indusoft, iFix and Labview. The ET-7000 also supports Web server access allowing the user to monitor and access the remote I/O from a Web browser. Users can also download their own custom defined pages into the ET-7000 via our Windows Utility. ICP DAS also provides a Java script page for the ET-7000 as a reference allowing design their own Web interface.

Configuration

- [Network Settings](#)
IP address, Net mask, default gateway, DHCP, Static or Dynamic IP, Firmware and OS version information...
- [Basic Settings](#)
Module name, Module information, Real Time Clock, Time Server IP address, Web server Enable, Disable functions. Load the factory default

3.2. Configuration

All items below are located under the **Configuration** menu:

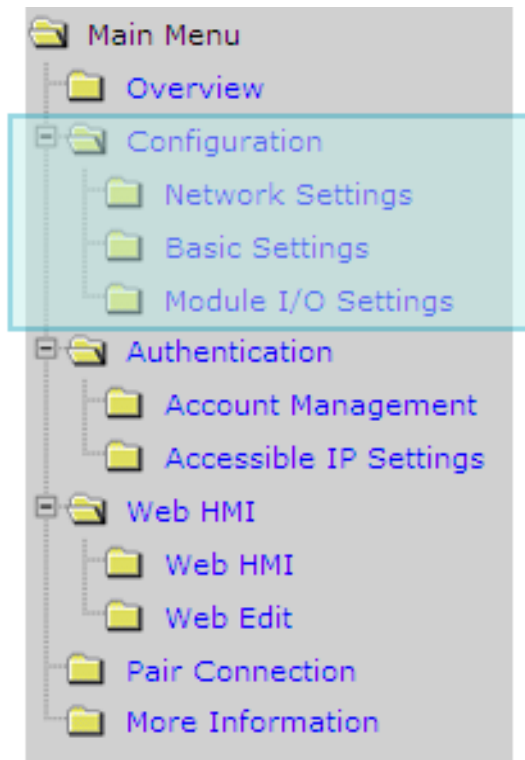

Network Settings: Links to the Ethernet Settings page that allows you to access the IP settings and check the software version.

Basic Settings: Links to the Basic Settings page that allows you to configure the basic information of this site.

Module I/O Settings: Links to the Common Functions page that allows you to configure the settings of the Modbus

3.2.1. Network Settings

The Ethernet Settings page provides the following functions:

Items	Current Value	New Value
IP	10.1.0.74	10.1.0.74
Gateway	10.1.0.254	10.1.0.254
Mask	255.255.0.0	255.255.0.0
DHCP	<input checked="" type="radio"/> Enable <input type="radio"/> Disable	
Web Server Lib Ver.	Version 113 (Mar 26 2009)	
MiniOS7 Ver.	Version 2.02.10	

[Please access the new IP Address after modifying the configuration](#)

- Configure the network settings
- Check the software information

3.2.1.1. Configure the Network Settings

A generally network setting includes the following parameters:

- **An IP address**: Each PET-7000/ET-7000 on the network must have a unique IP address. It is used to assign an IP address.
- **A default gateway**: A gateway (or router) is a system that is used to connect a network with one or more other networks.
- **A subnet mask**: The subnet mask indicates which portion of the IP address that is used to identify the local network or subnet.

There are two ways to configure the network settings:

- **Dynamic configuration**: Dynamic Host Configuration Protocol (DHCP) is a network application protocol that automatically assigns IP address to devices.
- **Manually configuration**: If you don't have a DHCP server in your network, you can configure network settings manually.

Dynamic Configuration

Dynamic configuration is very easy to configure. If you have a DHCP server, network address can be configured dynamically by following steps:

Items	Current Value	New Value
IP	10.1.0.46	10.1.0.46
Gateway	10.1.0.254	10.1.0.254
Mask	255.255.0	255.255.0.0
DHCP	<input checked="" type="radio"/> Enable <input type="radio"/> Disable	
Web Server Lib Ver.	Version 113 (Mar 26 2009)	
MiniOS7 Ver.	Version 2.02.9	
<input type="button" value="MODIFY_SETTING"/>		

Step 1: Enable the **DHCP**

Step 2: Click **MODIFY_SETTING** to finished configuring the network settings

Manually Configuration

In manual configuration, you have to assign all the network settings manually. To configure network settings manually, follow the following steps:

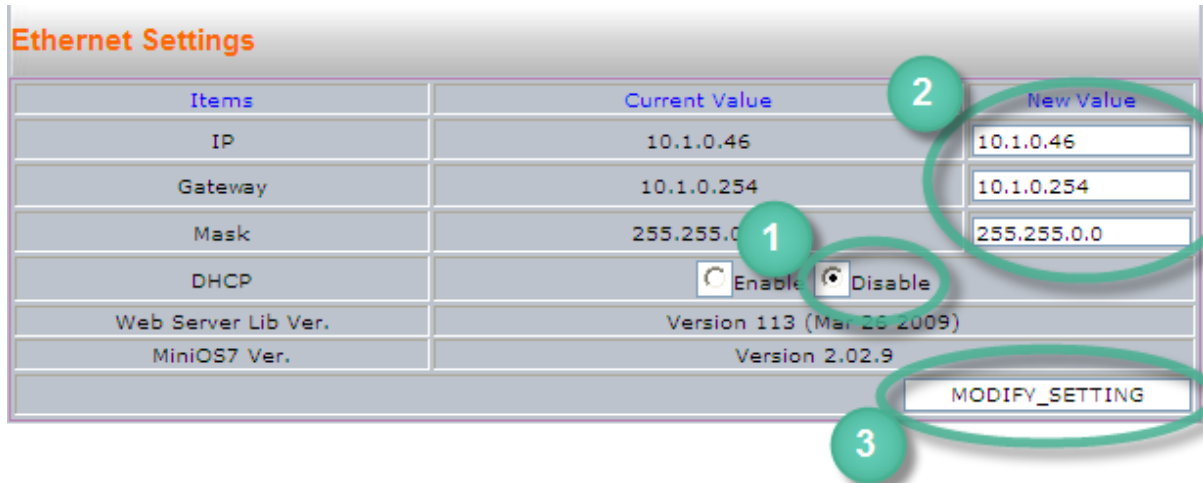

The screenshot shows the 'Ethernet Settings' configuration page. It features a table with columns for 'Items', 'Current Value', and 'New Value'. The 'DHCP' setting is currently set to 'Enable', and the 'MODIFY_SETTING' button is at the bottom right. Three green callout circles with numbers 1, 2, and 3 highlight the 'DHCP' radio buttons, the 'New Value' input fields, and the 'MODIFY_SETTING' button, respectively.

Items	Current Value	New Value
IP	10.1.0.46	10.1.0.46
Gateway	10.1.0.254	10.1.0.254
Mask	255.255.0	255.255.0.0
DHCP	<input type="radio"/> Enable <input checked="" type="radio"/> Disable	
Web Server Lib Ver.	Version 113 (Mar 26 2009)	
MiniOS7 Ver.	Version 2.02.9	
<input type="button" value="MODIFY_SETTING"/>		

Step 1: Disable the **DHCP**

Step 2: Enter the **network settings**

Step 3: Click **MODIFY_SETTING** to finished configuring the network settings_____

3.2.1.2. Check the software information

The software information includes the following data items:

- **Web Server Lib Ver.**: The version of the web server library. The web server library is a collection of web development solutions.
- **MiniOS7 Ver.**: The version of the MiniOS7 OS image. The MiniOS7 is an embedded OS designed for ICP DAS controller.

After updating the PET-7000/ET-7000 firmware, you can check the version of the PET-7000/ET-7000 software information.

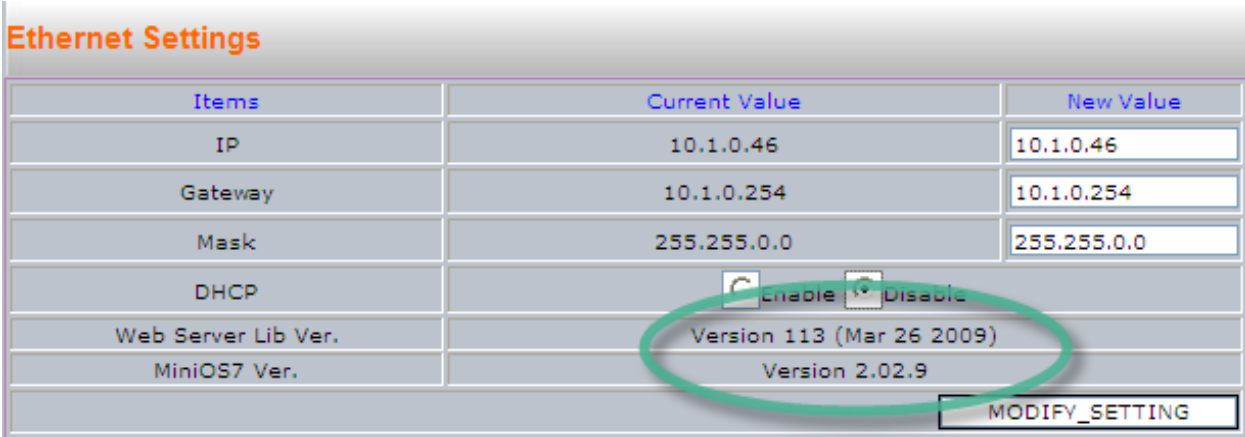

The screenshot shows the 'Ethernet Settings' interface. It contains a table with three columns: 'Items', 'Current Value', and 'New Value'. The rows include IP, Gateway, Mask, DHCP, Web Server Lib Ver., and MiniOS7 Ver. The 'Web Server Lib Ver.' and 'MiniOS7 Ver.' rows are circled in green. A 'MODIFY_SETTING' button is located at the bottom right of the table.

Items	Current Value	New Value
IP	10.1.0.46	10.1.0.46
Gateway	10.1.0.254	10.1.0.254
Mask	255.255.0.0	255.255.0.0
DHCP	<input checked="" type="checkbox"/> Enable <input type="checkbox"/> Disable	
Web Server Lib Ver.	Version 113 (Mar 26 2009)	
MiniOS7 Ver.	Version 2.02.9	

MODIFY_SETTING

3.2.2. Basic Settings

The Basic Settings page provides the following functions:

Basic Settings	
Module Name	ET-7026
Module Information	<input type="text"/> (Maximum 16 characters) (The content cannot include ' or " character)
Top page Information (First line)	ICP DAS (Maximum 20 characters) Color <input type="text" value="Red"/> Font <input type="text" value="0"/>
Top page Information (Second line)	<input type="text" value="http://www.icpdas.com"/> (Maximum 50 characters) Color <input type="text" value="Red"/> Font <input type="text" value="0"/>
More Information URL	<input type="text" value="http://www.icpdas.com/products/Remote_IO/et-7000/et"/> (Maximum 100 characters)
Web Server TCP Port	<input type="text" value="80"/>
<input type="button" value="Submit"/>	
Load All Setup Defaults	
<input type="checkbox"/>	Configuration
<input type="checkbox"/>	Authentication
<input type="checkbox"/>	Web HMI
<input type="checkbox"/>	Pair Connection
<input type="checkbox"/>	All
<input type="button" value="Submit"/>	

- Configure the module information
- Configure the web site information
- Reset all settings to default

3.2.2.1. Configure the Module Information

The module information includes the following data items:

- **Module Name:** The name of the module that can be modified. It has an initial value depending on the name of the module.
- **Module Information:** The module information indicates the name of the alias that is used to identify the module.

To configure the module information, follow the following steps:

Basic Settings	
Module Name	ET-7026
Module Information	<input type="text"/> (Maximum 16 characters) (The content cannot include ' or " character)
Top page Information (First line)	ICP DAS (Maximum 20 characters) Color Red <input type="button" value="v"/> Font 0
Top page Information (Second line)	<input type="text"/> (Maximum 50 characters) Color Red <input type="button" value="v"/> Font 0
More Information URL	<input type="text"/> (Maximum 100 characters) http://www.yshoo.com.tw
Web Server TCP Port	80
<input type="button" value="Submit"/>	

Step 1: Enter the **module information**

Step 2: Click **Submit** to finished configuring the module information

3.2.2.2. Configure the Web site Information

The module information includes the following data items:

- **Top page Information (First line)** and **Top page Information (Second line)**:

The title of the website that can be modified, you can view the title information in the top-left corner. The title information can be determined as follows:

ICP DAS ← Top page information (First line)
<http://www.icpdas.com> ← Top page information (Second line)

Basic Settings	
Module Name	ET-7026
Module Information	(Maximum 16 characters) (The content cannot include ' or " character)
Top page Information (First line)	ICP DAS (Maximum 20 characters)
Top page Information (Second line)	http://www.icpdas.com (Maximum 50 characters)
More Information URL	http://www.yahoo.com.tw (Maximum 100 characters)
Web Server TCP Port	80

Submit

- **More Information URL**: The URL of the more information menu that can be modified, you can specify the PET-7000/ET-7000 URL for getting additional PET-7000/ET-7000 supports.

ICP DAS
<http://www.icpdas.com>

Home About Company Products Download Distributors Partners Training Activity Catalog

Introduction
• Introduction
• Features
Module Naming Convention
• Module Naming Convention
Selection Guide
• Selection Guide

ET-7000 Web based I/O module

ET-7000 Selection Guide
Ethernet Switch Introduction
Ethernet Switch Catalog

SCADA
Ring Switch
Ring Switch
Ring Switch
Backup soft

- **Web Server TCP Port:** A port number of the TCP/IP port. A port number is a 16-bit unsigned integer. By default, TCP/IP uses port 80.

To configure the web site information, follow the following steps:

Basic Settings	
Module Name	ET-7026
Module Information	<input type="text"/> (Maximum 16 characters) (The content cannot include " or " character)
Top page Information (First line)	ICP DAS (Maximum 20 characters) Color Red Font 0
Top page Information (Second line)	http://www.icpdas.com (Maximum 50 characters) Color Red Font 0
More Information URL	http://www.yahoo.com.tw (Maximum 100 characters)
Web Server TCP Port	80
<input type="button" value="Submit"/>	

Step 1: Enter the **web site information**

Step 2: Click **Submit** to finished configuring the module information

3.2.2.3. Reset All Settings to Default

According to the menu selection of this web, the reset function can be divided into the following categories. You can use this function to reset the settings to their factory default.

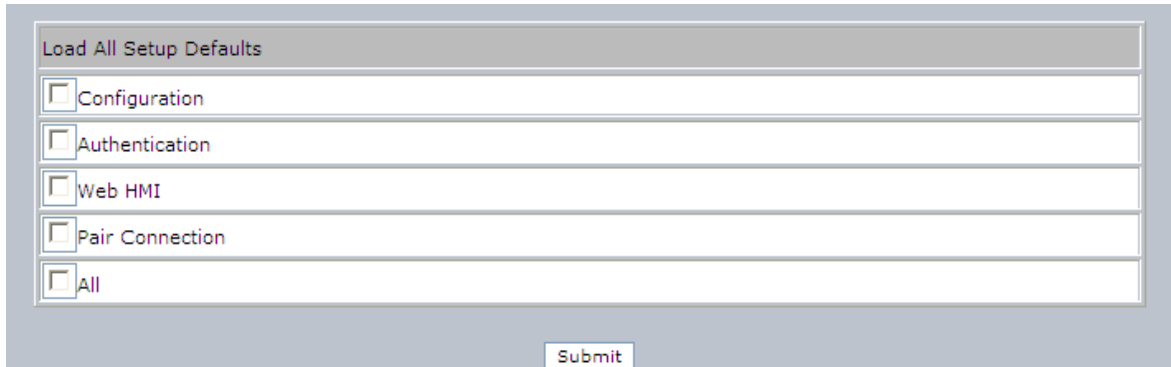

The screenshot shows a web form titled "Load All Setup Defaults". It contains five rows, each with a checkbox and a label: "Configuration", "Authentication", "Web HMI", "Pair Connection", and "All". Below the form is a "Submit" button.

- Configuration
- Authentication
- Web HMI
- Pair Connection
- All

To reset the settings to their factory default, follow the following steps:

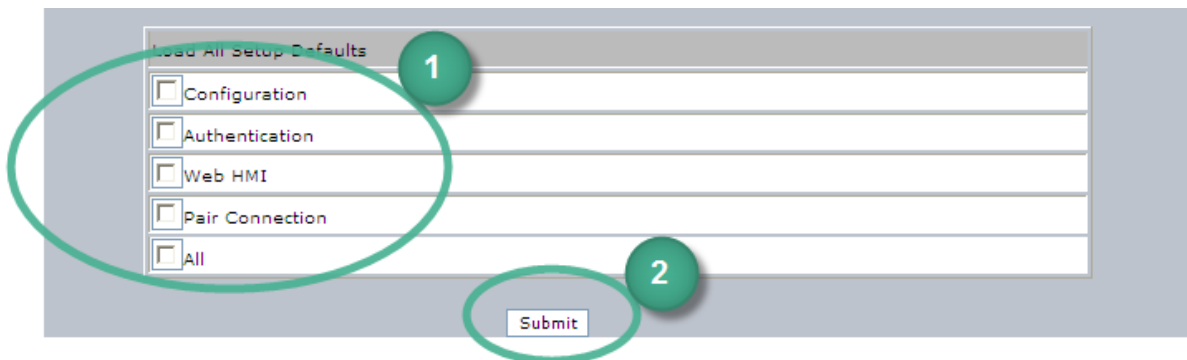

The screenshot is annotated with two green circles and numbers. Circle 1 highlights the checkboxes for "Configuration", "Authentication", "Web HMI", "Pair Connection", and "All". Circle 2 highlights the "Submit" button.

Step 1: Enable the **reset selection**

Step 2: Click **Submit** to finished resetting the settings to their factory default

3.2.2.3.1 Factory Default Settings for Configuration Menu Service

The table below lists the factory default settings of the configuration menu.

Network Settings

Data Item	Factory Default Settings
IP	192.168.255.1
Gateway	192.168.0.1
Mask	255.255.0.0
DHCP	Disable

Basic Settings

Data Item	Factory Default Setting
Module Name	Depending on the module name
Module Information	Empty
Top page Information (First line)	ICP DAS
Top page Information (Second line)	http://www.icpdas.com
More Information URL	http://www.icpdas.com/products/Remote_IO/et-7000/et-7000_introduction.htm
Web Server TCP Port	80
Configuration	Disable
Authentication	Disable
Web HMI	Disable
Pair	Disable
All	Disable

Module I/O Settings

Common Functions

Modbus Address	Function	Factory Default Setting
00226	Recover all I/O default settings	Disable
00233	Reboot PET-7000/ET-7000	Disable
40555	CPU reset status	1 (Power on)
40556	CPU reset events	1 reset count
40557	Set Host Watchdog Timer	0
40558	Host WDT events	0 WDT count

Modbus Functions

Modbus Address	Function	Factory Default Setting
40271	Modbus NetID	1

Power/Safe Value

Channel Address	Power Value (00435)	Safe Value (00515)
Ch0	OFF	OFF
Ch1	OFF	OFF

DI Latch

Modbus Address	Function	Factory Default Setting
00350	Enable ID latched status	OFF

DI Counter

Channel Address	Enable (00351)	Preset Value for Digital Counter (40200)
Ch0	OFF	0
Ch1	OFF	0

Basic Setting		
Channel Address	Range (40459)	Slew Rate (40523)
Ch0	32 (0V ~ 10V)	0 (Immediate)
Ch1	32 (0V ~ 10V)	0 (Immediate)

AO Power/Safe Value		
Channel Address	Power Value (40360)	Safe Value (40392)
Ch0	0.000	0.000
Ch1	0.000	0.000

Basic Setting		
Channel Address	Function	Enable (00595)
Ch0	08 (-10V ~ 10V)	ON
Ch1	08 (-10V ~ 10V)	ON
Ch2	07 (4mA ~ 20mA)	ON
Ch3	07 (4mA ~ 20mA)	ON
Ch4	07 (4mA ~ 20mA)	ON
Ch5	07 (4mA ~ 20mA)	ON

Modbus	Function	Default Settings
00628	Normal (16 bits & 10 Hz)/Fast mode (12 bits & 60 Hz) for AI	OFF (Normal mode)
00629	50/60 Hz rejection for AI	OFF (60 Hz rejection)
00631	AI Data Format	OFF (Hex)
00632	Recover AI Calibration Values to Factory Setting	Disable

3.2.2.3.2 Factory Default Settings for Authentication Menu Service

The table below lists the factory default settings of the Authentication menu.

Account Management

Factory Default Setting
A default user account consists of a account name “Admin” and a password “Admin”.

Accessible IP Settings

Factory Default Setting
Empty, there is no limit to allow any outgoing access.

3.2.2.3.3 Factory Default Settings for Web HMI Menu Service

The table below lists the factory default settings of the Web HMI menu.

Web HMI

Factory Default Setting
Depending on the Modbus setting function of the PET-7000/ET-7000.

Web Editing

Factory Default Setting
0 Page

3.2.2.3.4 Factory Default Settings for Pair Connection Menu Service

The table below lists the factory default settings of the Web HMI menu.

Pair Connection

Factory Default Setting
Empty

3.2.3. Module I/O Settings

The Common Function page provides options to configure the settings of the Modbus functions.

Common Functions

Common Functions

Modbus Address	Function	Action
00226	Recover all I/O default settings	<input type="checkbox"/> 1=Clear
00233	Reboot ET-7000	<input type="checkbox"/> 1=Reboot
40555	CPU reset status	3 <input type="text"/> 1= power on/2= 0.8 second WDT/3= Reset command
40556	CPU reset events	18 <input type="text"/> reset count
40557	Set Host Watchdog Timer	0 <input type="text"/> 5:Disable 5~65535:Enable (unit:second) (default=0)
40558	Host WDT events	0 <input type="text"/> WDT count

Modbus Definition

Modbus Address	Function	Action
40271	Modbus NetID	1 <input type="text"/> 1 ~ 255 (default=1)

This page display different contents depending on the Modbus function of the PET-7000/ET-7000 module.

All of these settings can be divided into either common, DI, DO, AI and AO settings.

For a more detailed description of these Modbus function, please refer to section “4.3. Modbus Register Map”.

3.3. Authentication

All items below are located under the **Authentication** menu:

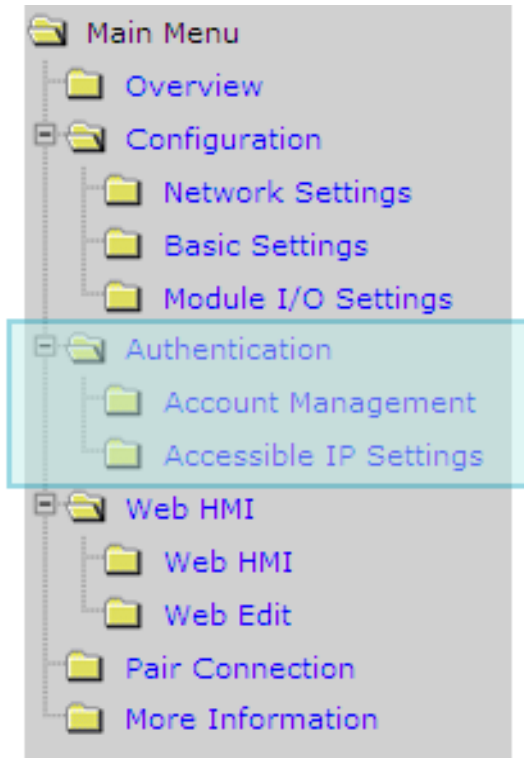

Account Management: Links to the Privilege management page that allows you to manage the user accounts and their privileges.

Accessible IP Settings: Links to the IP filter Settings page that allow you to control access to the web site

3.3.1. Account Management

The Basic Settings page provides the following functions:

No.	Account	Password	Verify	Authority	Enable
1	Admin	••••	••••	Admin	On
2	<input type="text"/>	<input type="text"/>	<input type="text"/>	Admin ▼	<input type="checkbox"/>
3	<input type="text"/>	<input type="text"/>	<input type="text"/>	Admin ▼	<input type="checkbox"/>
4	<input type="text"/>	<input type="text"/>	<input type="text"/>	Admin ▼	<input type="checkbox"/>
5	<input type="text"/>	<input type="text"/>	<input type="text"/>	Admin ▼	<input type="checkbox"/>

Account: (Maximum 8 characters)
Password: (Maximum 8 characters)

Load Setup Default

- Configure the user accounts
- Load the factory default user account

3.3.1.1. Configure the user accounts

The PET-7000/ET-7000 web site supports up to 5 user accounts.

- A built-in administrator account

The built-in Administrator is basically a setup and disaster recovery account that can be deleted. You can change the administrator account's password.

- Four user-defined account

Each user account consists of

- An **account** name: Specifies the name of This can be your name or another alias
- A **password**: The system will ask you to type this in twice to ensure it is correct.
- The **authority**: that determines what operations the user is allowed to perform.

The authority has the following roles to determine what operations the user is allowed to perform.

- **Admin**: Enables access to all PET-7000/ET-7000 website features, functions, and commands.
- **User**: Enables limited access to PET-7000/ET-7000 website features, functions, and commands. In general, operators cannot change configuration settings.

When you create user accounts, you can **Enable** or **Disable** user accounts.

No.	Account	Password	Verify	Authority	Enable
1	Admin	Admin	On
2	ET7000	User	<input checked="" type="checkbox"/>
3	ICPDAS	Admin	<input checked="" type="checkbox"/>
4				Admin	<input type="checkbox"/>
5				Admin	<input type="checkbox"/>

Submit

Account: (Maximum 8 characters)
Password: (Maximum 8 characters)

Step 1: Enter the **user account** information, and then select the **enable** checkbox

Step 2: Click **Submit** to finished configuring the user accounts

3.3.1.2. Load the factory default user accounts

The PET-7000/ET-7000 has a built-in administrator account named **Admin** which is created when it is installed by default. The default account cannot be deleted.

The screenshot shows a web interface titled "Privilege management". It contains a table with the following columns: No., Account, Password, Verify, Authority, and Enable. The first row shows an "Admin" account with masked passwords and "Admin" authority. Below the table is a "Submit" button. At the bottom, there are two input fields: "Account:" (maximum 8 characters) and "Password:" (maximum 8 characters). Below these fields is a checkbox labeled "Load Setup Default" and a "Submit" button. The checkbox and the "Submit" button are circled in green, with a green circle containing the number "1" next to the checkbox and a green circle containing the number "2" next to the "Submit" button.

No.	Account	Password	Verify	Authority	Enable
1	Admin	****	****	Admin	On
2	<input type="text"/>	<input type="text"/>	<input type="text"/>	Admin	<input type="checkbox"/>
3	<input type="text"/>	<input type="text"/>	<input type="text"/>	Admin	<input type="checkbox"/>
4	<input type="text"/>	<input type="text"/>	<input type="text"/>	Admin	<input type="checkbox"/>
5	<input type="text"/>	<input type="text"/>	<input type="text"/>	Admin	<input type="checkbox"/>

Account: (maximum 8 characters)
Password: (maximum 8 characters)

Load Setup Default

Step 1: Select the **Load Setup Default** checkbox

Step 2: Click **Submit** to finished configuring the user accounts

3.3.2. Accessible IP Settings

The IP filter Settings page provides the following functions:

IP filter Settings

Enable the IP filter table. ("Disable" will allow connection requests from all IPs.)

IP address at the browser PC: 10.1.0.37

No.	Active the rule	From (IP Address)	To (IP Address)
1	<input type="checkbox"/>	<input type="text"/>	<input type="text"/>
2	<input type="checkbox"/>	<input type="text"/>	<input type="text"/>
3	<input type="checkbox"/>	<input type="text"/>	<input type="text"/>
4	<input type="checkbox"/>	<input type="text"/>	<input type="text"/>
5	<input type="checkbox"/>	<input type="text"/>	<input type="text"/>
6	<input type="checkbox"/>	<input type="text"/>	<input type="text"/>

Submit

- Configure connection filtering

3.3.2.1. Configuring IP filter

The PET-7000/ET-7000 with an IP filter that enables you to restrict or grant user access based on an IP filter list you create.

The filter can be enabled or disabled by selecting the **Enable the IP filter table** checkbox

Enable the IP filter table. ("Disable" will allow connection requests from all IPs.)

Tips & Warnings



By default, there is no limit to allow any outgoing access.

Each list entry can be active or inactive by clicking its Active the rule

No.	Active the rule	From (IP Address)	To (IP Address)
1	<input checked="" type="checkbox"/>	10.1.0.1	10.1.8.9

Here we provide two basic methods for configuring the IP filter.

- **Method 1: Allows access from a single IP address**

IP filter settings

Enable the IP filter table. ("Disable" IP address at the browser PC: 10.1.0.37)

No.	Active the rule	From (IP Address)	To (IP Address)
1	<input checked="" type="checkbox"/>	10.1.0.1	10.1.0.1
2	<input type="checkbox"/>		
3	<input type="checkbox"/>		
4	<input type="checkbox"/>		
5	<input type="checkbox"/>		
6	<input type="checkbox"/>		

Step 1: Select the **Enable the IP filter table** checkbox

Step 2: Enter the same IP address in the **From (IP Address)** and **To (IP Address)**

Step 3: Select the **Active the rule** checkbox

Step 4: Click **Submit** to finished configuring the IP filter list

- **Method 2: Allow access from a group of IP addresses**

IP filter settings

Enable the IP filter table. ("Disable" IP address at the browser PC: 10.1.0.37)

No.	Active the rule	From (IP Address)	To (IP Address)
1	<input checked="" type="checkbox"/>	10.1.0.1	10.1.8.9
2	<input type="checkbox"/>		
3	<input type="checkbox"/>		
4	<input type="checkbox"/>		
5	<input type="checkbox"/>		
6	<input type="checkbox"/>		

Step 1: Select the **Enable the IP filter table** checkbox

Step 2: Enter a range of IP addresses in the **From (IP Address)** and **To (IP Address)**

Step 3: Select the **Active the rule** checkbox

Step 4: Click **Submit** to finished configuring the IP filter list

3.4. Web HMI

All items below are located under the **Web HMI** menu:

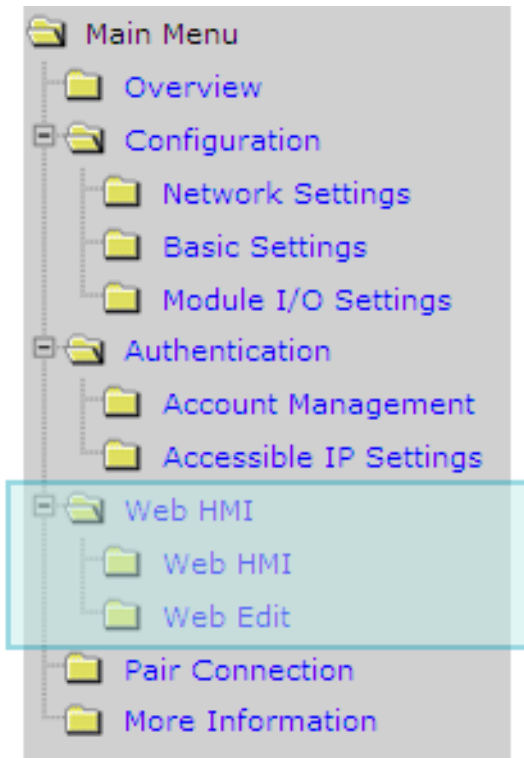

Web HMI: Links to the I/O monitor page that allows you to monitor the

Web Edit: Links to the Web Page Configuration page that allows you to

3.4.1. Web HMI

By default, this page displays summary information about I/O channels which are classified according to the module type.

Here you can add more tabs and set the starting tab by editing the web edit page, for more details, please refer to 3.4.2. Web Edit.

The screenshot shows a web HMI interface with a navigation bar at the top containing tabs: AI, DO, AI Average value, Pair, and Page0-Group1. The main area features a 3D perspective view of a PLC rack with four orange modules. The leftmost module is labeled 'PHS' with a ground symbol. The second module from the left has a 'Motor' label with a purple arrow pointing to a component. The third module has a 'Products' label. Below the diagram is a table with the following data:

PointNo	Register	Alias	Status/Action
0	00000	DO	<input type="checkbox"/> ON <input type="checkbox"/> OFF
1	30000	Voltage1	FFFD

At the bottom of the interface, there is a 'Scan rate' field set to '1000 ms' and a 'Communication Status' field showing 'Good'. A 'Submit' button is located to the right of the scan rate field.

3.4.2. Web Edit

The Web Editing page provides functions to create the user-defined web pages which are displayed on the Web HMI page.

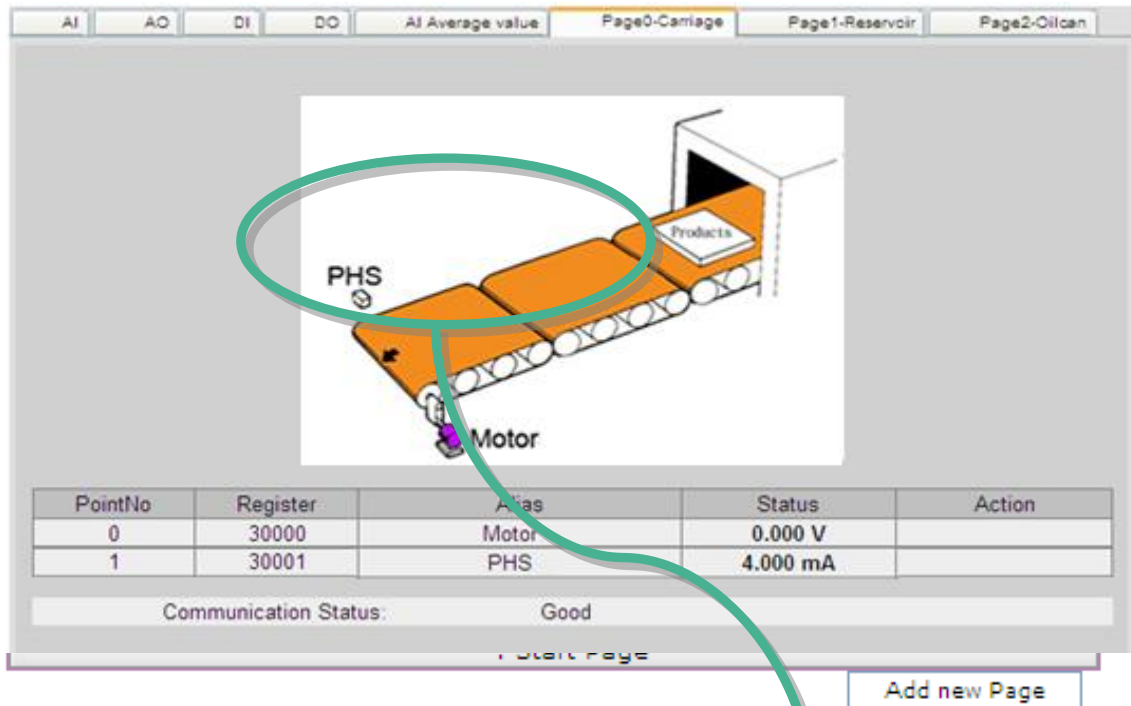

Web HMI page

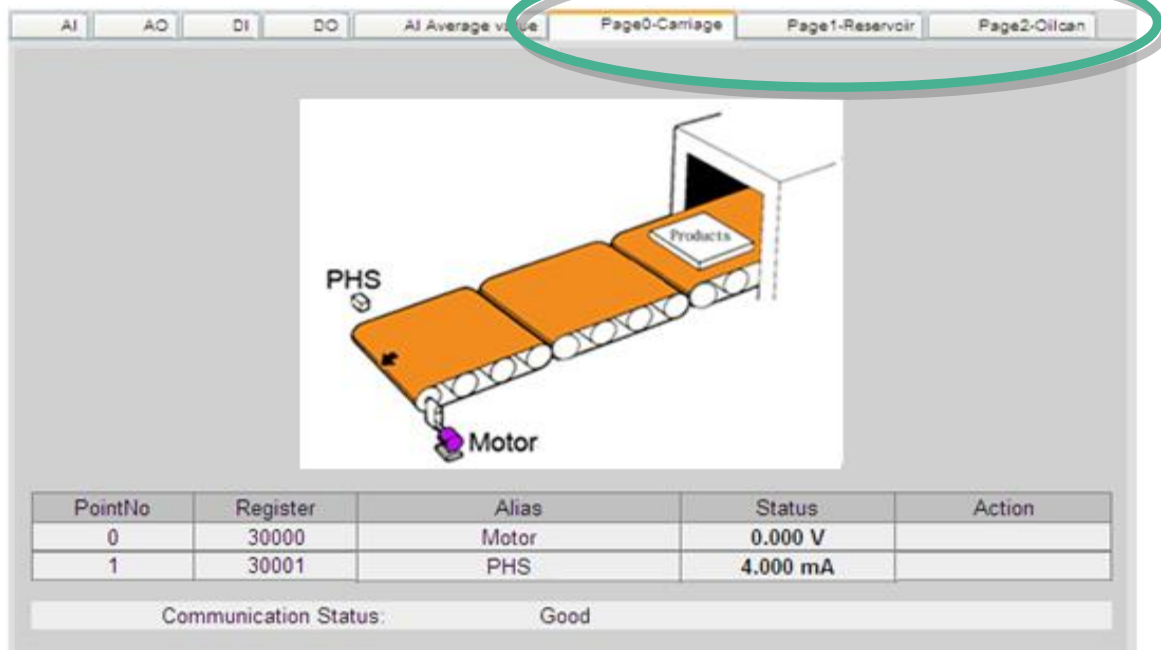

By default, there are no pages to be listed in the Web Page Configuration form.

The screenshot shows the 'Web Page Configuration' interface. At the top, there is a dropdown menu set to 'MainPage' and a 'Go' button. Below this is a table with three columns: 'No', 'Page Description', and 'Function'. The table contains one row with 'No' as an asterisk (*), 'Page Description' as 'Main Page', and 'Function' as an empty cell. At the bottom of the table area, there is a note '*: Start Page' and an 'Add new Page' button.

No	Page Description	Function
*	Main Page	

*: Start Page

Add new Page

The PET-7000/ET-7000 supports up to 10 user-defined web pages

The screenshot shows the 'Web Page Configuration' interface with 10 user-defined pages. The table has three columns: 'No', 'Page Description', and 'Function'. The 'Function' column is split into two sub-columns, 'Edit' and 'Delete'. A green arrow points from the number '10' in the 'No' column to a callout box.

No	Page Description	Function	
*	Main Page		
1	floor 1	Edit	Delete
2	floor 2	Edit	Delete
3	floor 3	Edit	Delete
4	floor 4	Edit	Delete
5	floor 5	Edit	Delete
6	floor 6	Edit	Delete
7	floor 7	Edit	Delete
8	floor 8	Edit	Delete
9	floor 9	Edit	Delete
10	floor 10	Edit	Delete

*: Start Page

Add new Page

A maximum of 10 pages can be created.

Below is an example of how to create your own page.

Example:

Create a Web page to monitor the I/O of the conveyer system shown below. The I/O system contains a sensor that are used to detect the products, and a switch that are used to turn the conveyer motor on and off.

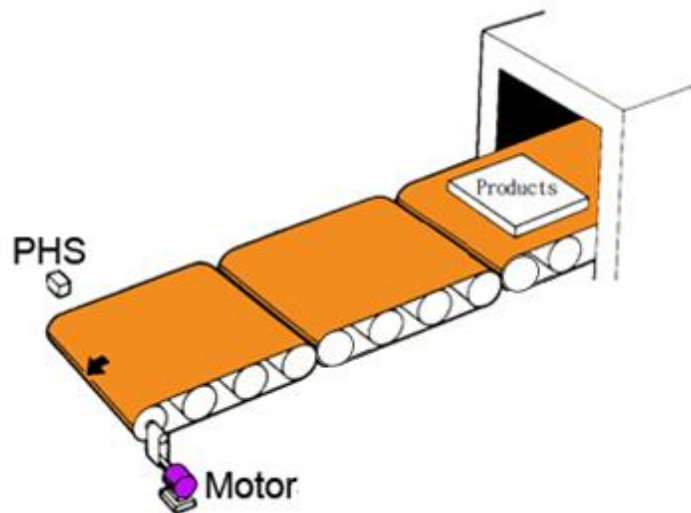

Step 1: Add a new page

Click **Add new Page**

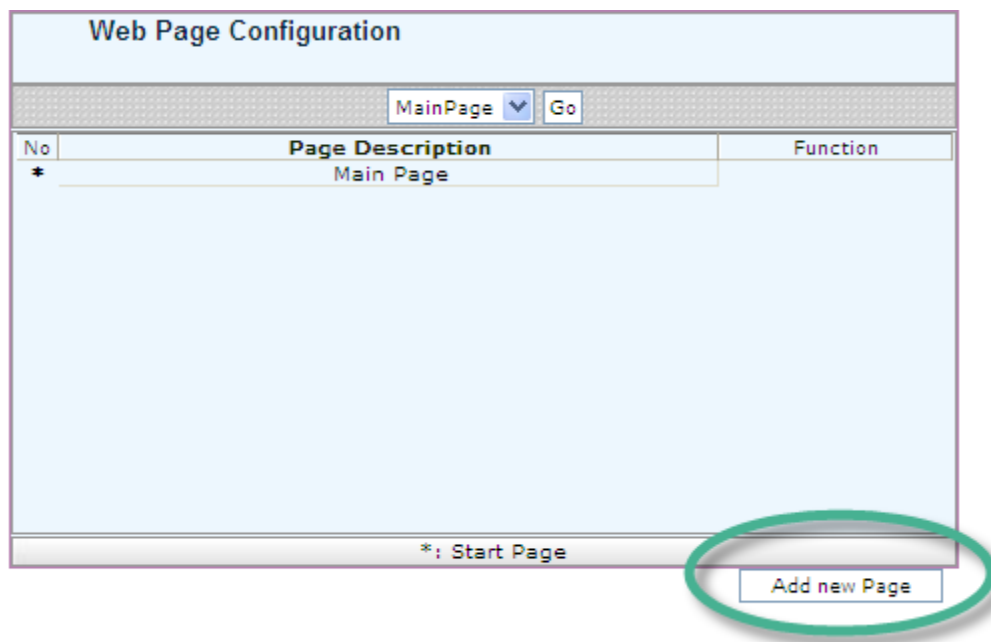

Step 2: Upload a diagram

Click **Browse...** to select an image, and then click **Upload** to upload images to the PET-7000/ET-7000 module.



Tips & Warnings



The file type of images can be either of .jpg, .gif, or .bmp. The recommended resolution for the image to be displayed on the editing Web page is 340 * 250 pixels.

After the upload is completed, the image information will be displayed and the image will be added in the Image list box as below shown.

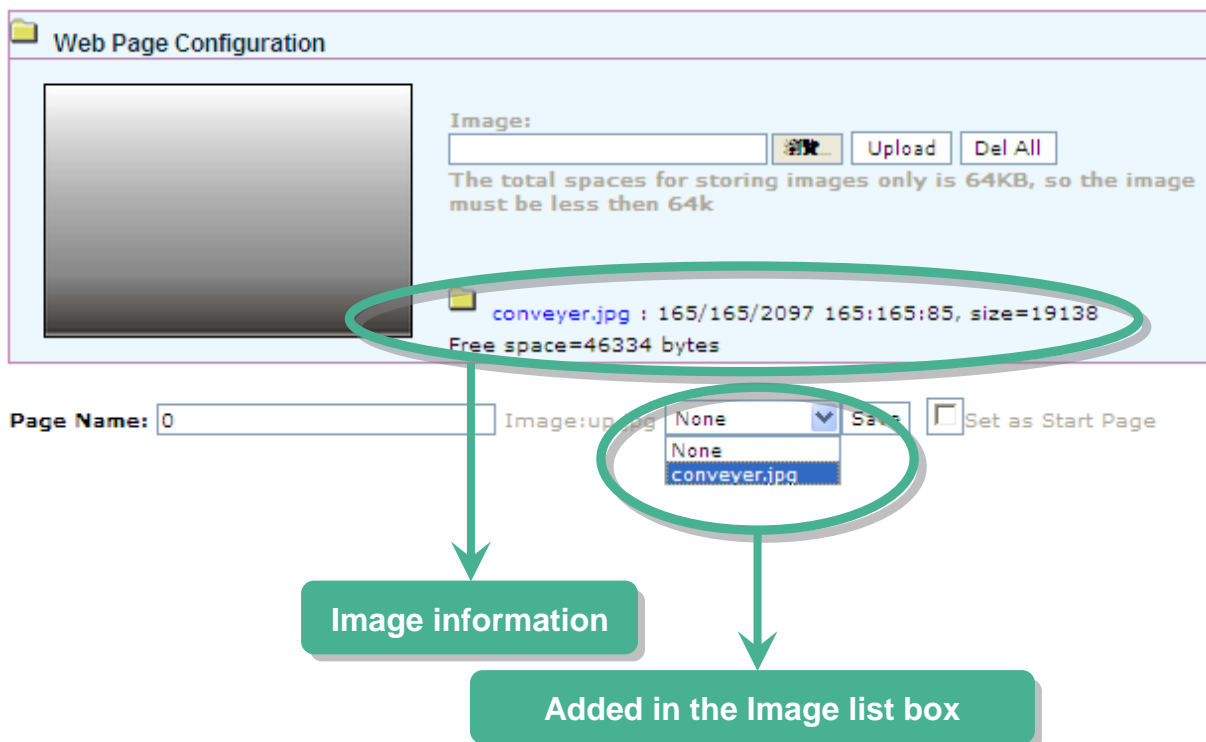

Step 3: Set the page name and select the diagram

Type the page name in the **Page Name** field and then select the diagram from the **Image** list box. (After selecting the diagram, the diagram will be shown in the Preview window)

Step 4: Add the register item for reading selected sensor input

Click **Edit** in the first row of the **Group** table and then the **Edit Group Register** window will be displayed.

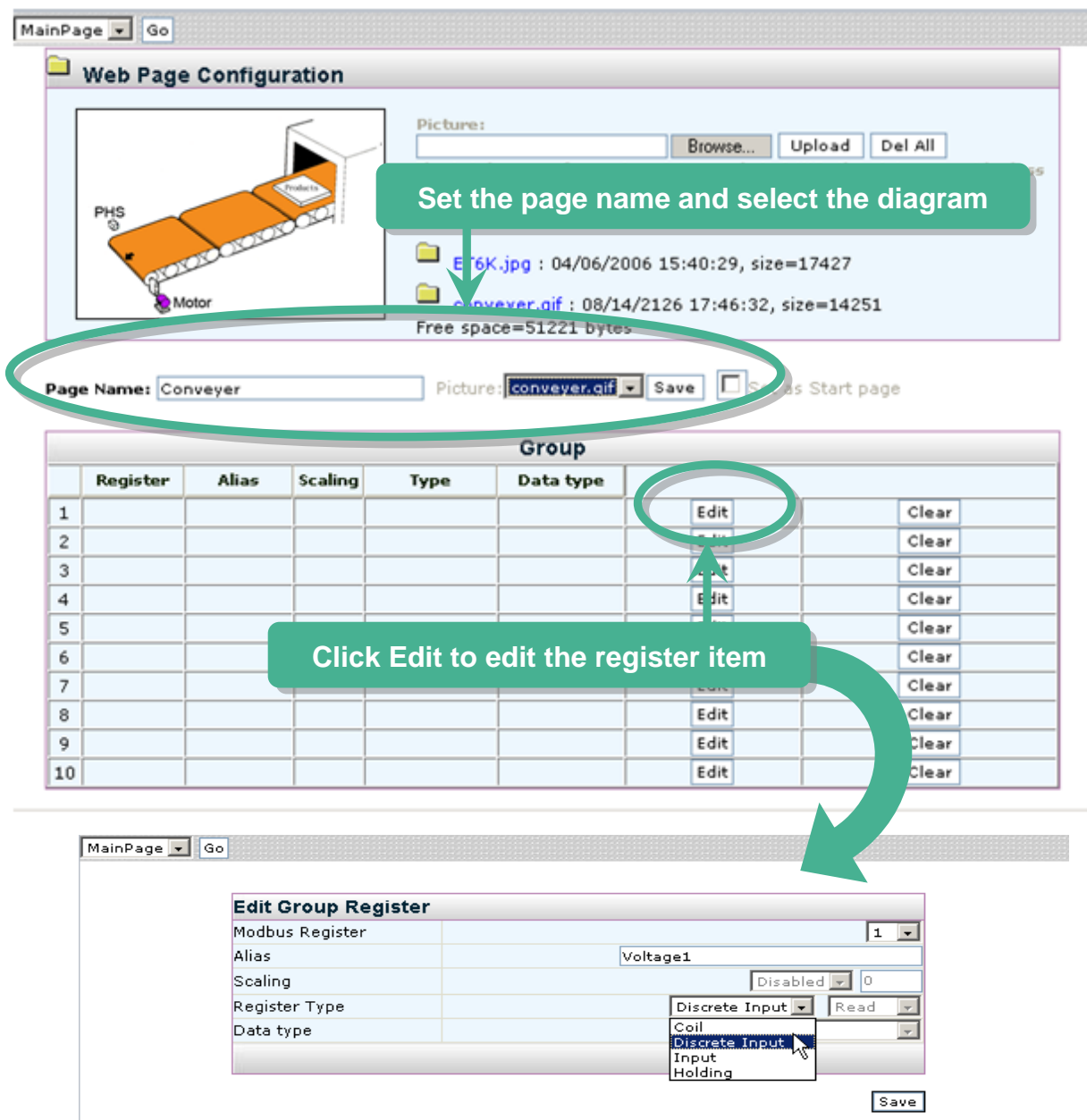

Step 5: Add a DI for reading PHS1 input
 Set PHS1 to be an input, you can using the **Modbus Register 1**, then select **Discrete Input** as the **Register Type** and type **PHS** as the **Alias**.

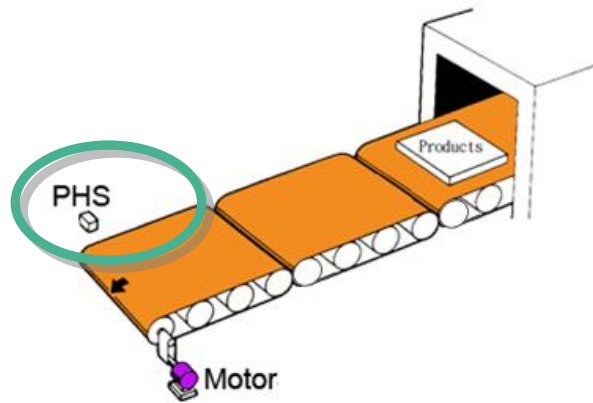

Step 6: Save selected sensor settings
 Click **Save** button to complete set up

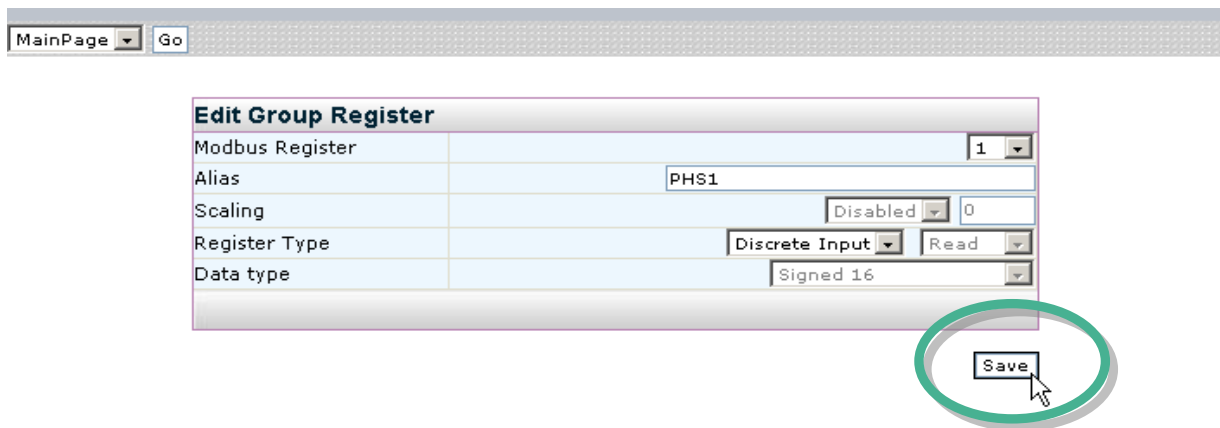

Step 7: Add the register item for writing selected motor output to turn/
 After save the register settings, the new register item will be displayed in the **Group** table.
 Click **Edit** in the second row of the **Group** table and then the **Edit Group Register** window will be displayed.

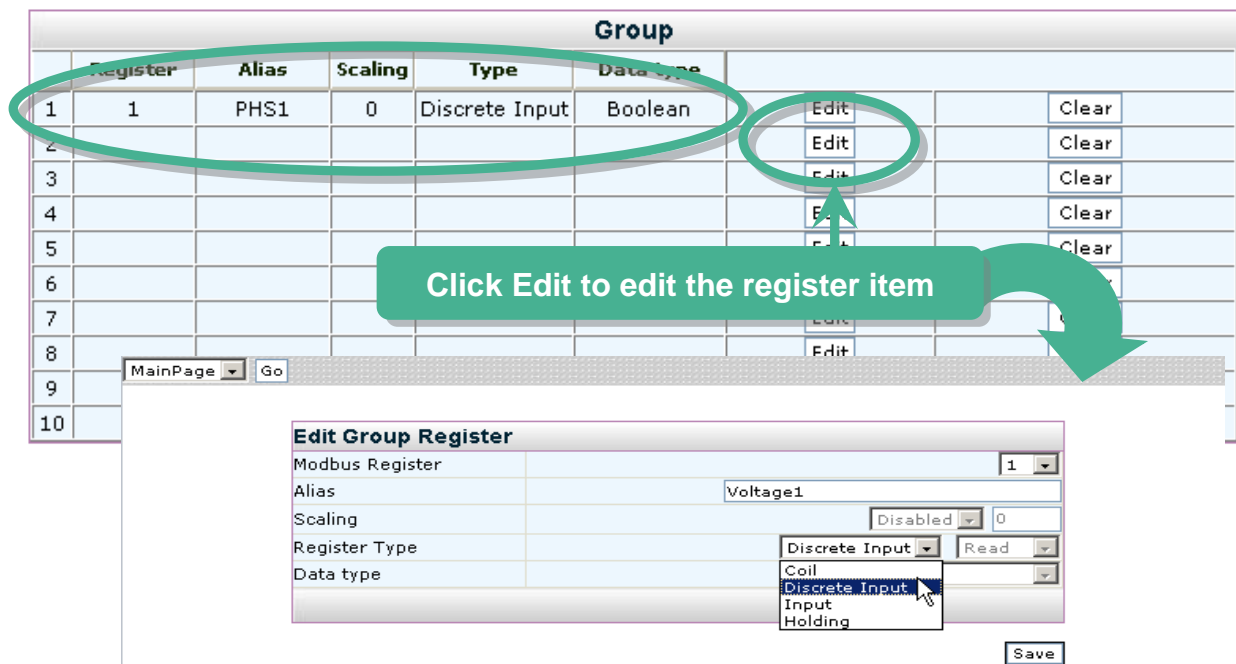

Step 8: Add a DO for writing Motor1 output to turn the conveyer motor on and off
 Set Motor to be an output, you can using the **Modbus Register 1**, then select **Coil** as the **Register Type** and type **Motor** as the **Alias**.

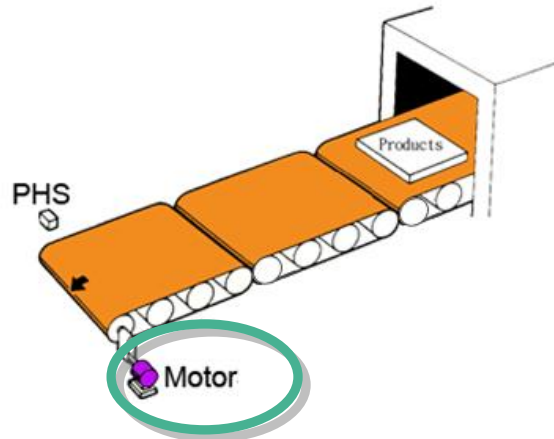

Step 9: Save selected sensor settings
 Click **Save** button to complete set up

MainPage Go

Edit Group Register

Modbus Register	1
Alias	Motor1
Scaling	Disabled 0
Register Type	Coil Write
Data type	Signed 16

Save

Step 10: Save the editing page.
 Click **Save** button to complete set up

MainPage Go

Web Page Configuration

Picture: **Browse...** **Upload** **Del All**

The total spaces for saving picture only is 64KB, the picture must be less than 64k

- ET6K.jpg : 04/06/2006 15:40:29, size=17427
- conveyer.gif : 08/14/2126 17:46:32, size=14251

Free space=51221 bytes

Page Name: Picture: **Save** Set as Start page

Group							
Register	Alias	Scaling	Type	Data type			
1	1	PHS1	0	Discrete Input	Boolean	Edit	Clear
2	2	PHS2	0	Discrete Input	Boolean	Edit	Clear
3						Edit	Clear
4						Edit	Clear
5						Edit	Clear
6						Edit	Clear
7						Edit	Clear
8						Edit	Clear
9						Edit	Clear
10						Edit	Clear

Step 11: Browse the Conveyor web page.

After saving the editing page, the editing page named as **Conveyor** has been added to the list box on the top-left hand side of the **Web Page Configuration** window. Then select the **Conveyor** item and click **Go** to browse to the **Conveyor** web page.

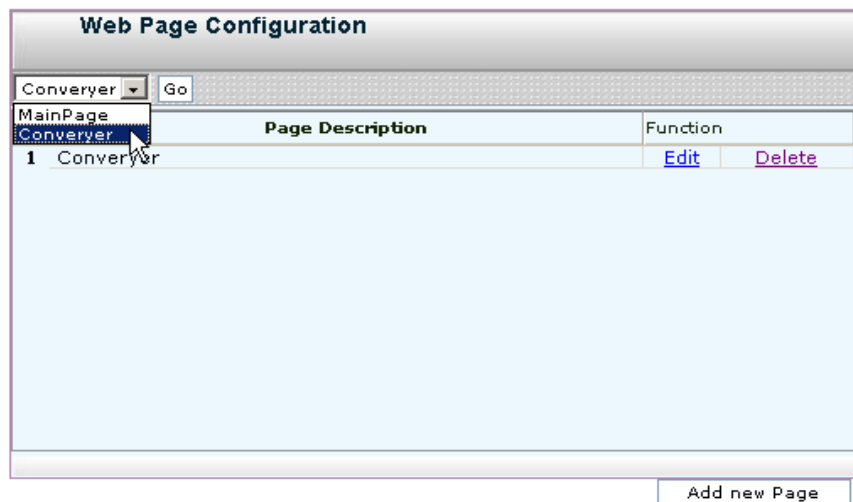

The conveyor image file and all register items will be displayed on the **Conveyor** web page.

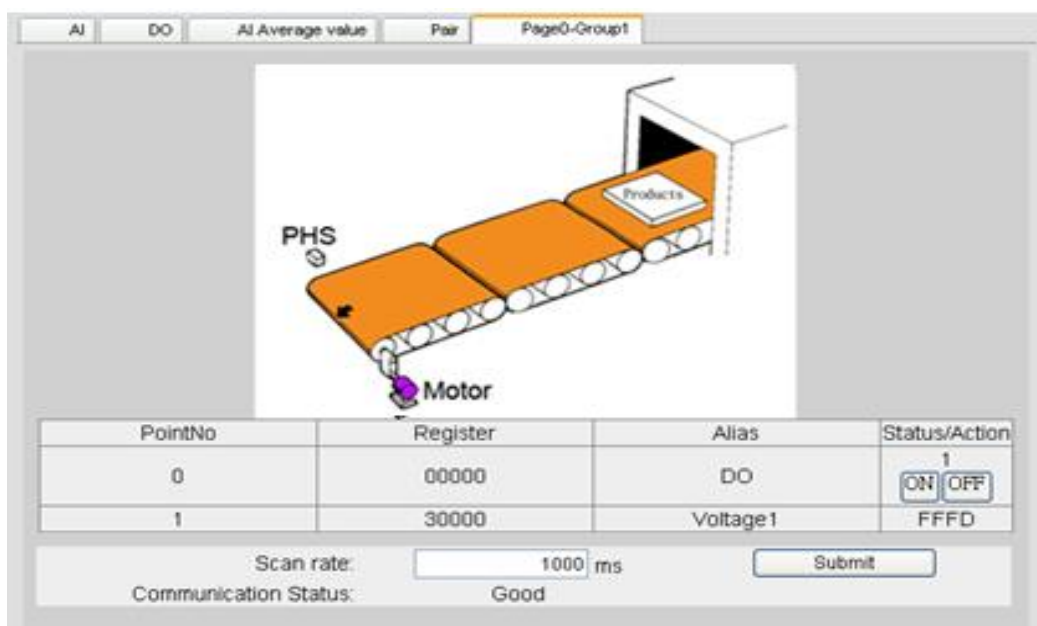

3.5. Pair Connection

The Pair Connection links to the configuration page of the pair connection function.



This pair connection function is a particular feature of PET-7000/ET-7000 that can enable a pair of DI-to-DO via Modbus/TCP (Ethernet).

Modbus Settings

Modbus port	502		
<input type="checkbox"/> I/O Pair connection			
Remote IP Address	<input type="text"/>	Remote TCP Port	0 <input type="text"/>
Connection Timeout	0 <input type="text"/> ms	Reconnect Interval	0 <input type="text"/> ms
Remote Net ID	0 <input type="text"/>	Scan Time	0 <input type="text"/> ms
Access Type	DO <input type="checkbox"/>		
Local DO Base Address	0 <input type="text"/>	Remote DI Base Address	0 <input type="text"/>
I/O Count	0 <input type="text"/>	Communication Timeout	0 <input type="text"/> ms
Access Type	AO <input type="checkbox"/>		
Local AO Base Address	0 <input type="text"/>	Remote AI Base Address	0 <input type="text"/>
I/O Count	0 <input type="text"/>	Communication Timeout	0 <input type="text"/> ms
<input type="button" value="Submit"/>			

3.6. More Information

The More Information links to the PET-7000/ET-7000 web site that provides more detailed information related to PET-7000/ET-7000 series products.

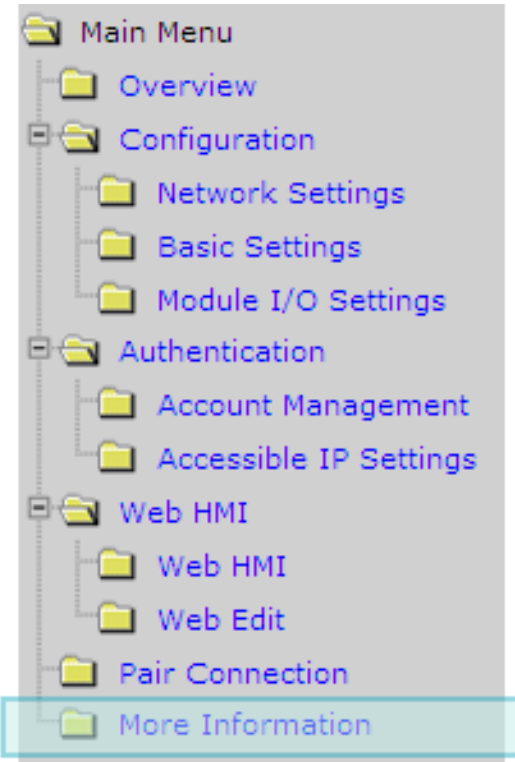

You can change the URL of this link by simply editing the URL, for more details, please refer to section “3.2.2.2. Configure the Web site Information”

The default URL of the More Information item is:

http://www.icpdas.com/products/Remote_IO/et-7000/et-7000_introduction.htm

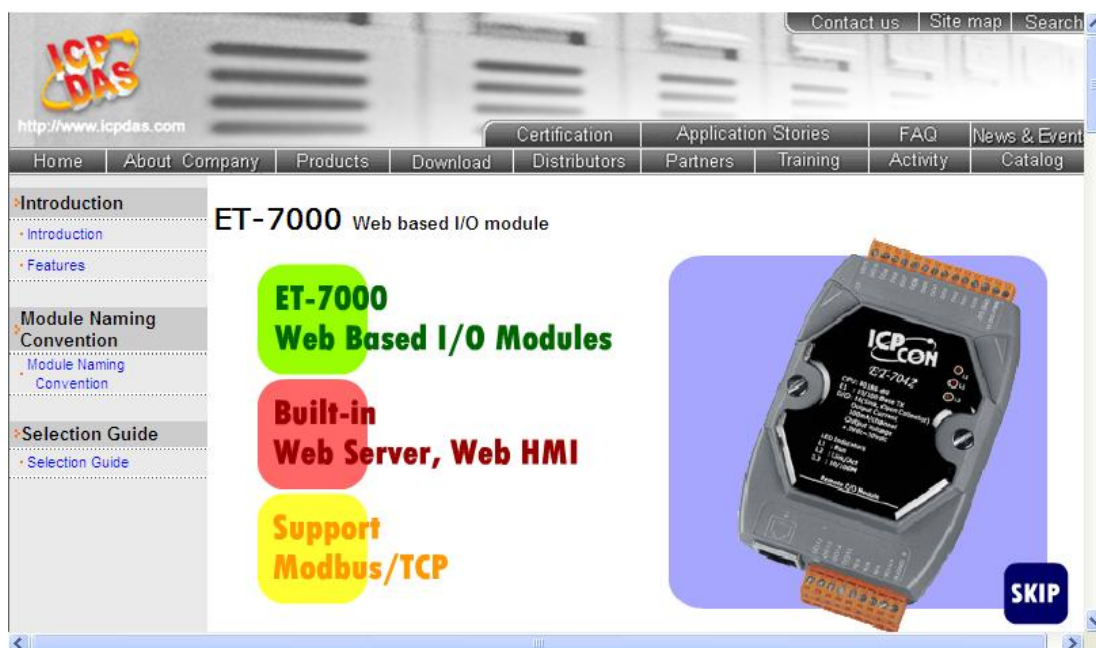

Chapter 4. Modbus Applications

The PET-7000/ET-7000 is a Modbus device that allows you to access terminals data via Ethernet and communicates using a master-slave technique in which only one device (the master) can initiate transactions (called queries). The other devices (slaves) respond by supplying the requested data to the master, or by taking the action requested in the query.

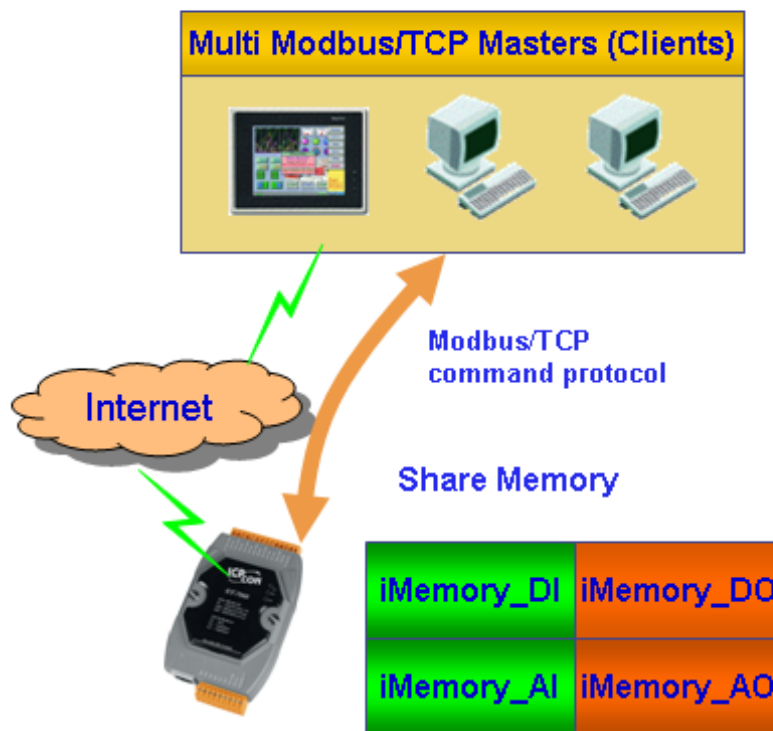

Most SCADA Supervisor Control And Data Acquisition and HMI software can easily integrate serial devices via the Modbus protocol, such as Citect, ICONICS, iFIX, InduSoft, Intouch, Entivity Studio, Entivity Live, Entivity VLC, Trace Mode, Wizcon, Wonderware, etc.

4.1. What is Modbus TCP/IP?

Modbus is a communication protocol developed by Modicon in 1979.

Different versions of Modbus used today include Modbus RTU (based on serial communication like RS485 and RS232), Modbus ASCII and Modbus TCP, which is the Modbus RTU protocol embedded into TCP packets.

Modbus TCP is an internet protocol. The protocol embeds a Modbus frame into a TCP frame so that a connection oriented approach is obtained thereby making it reliable. The master query's the slave and the slave responds with the reply. The protocol is open and hence highly scalable.

4.2. Modbus Message Structure

Modbus devices communicate using a master-slave (client-server) technique in which only one device (the master/client) can initiate transactions (called queries). The other devices (slaves/servers) respond by supplying the requested data to the master, or by taking the action requested in the query.

A master's query will consist of a slave address (or broadcast address), a function code defining the requested action, any required data, and an error checking field. A slave's response consists of fields confirming the action taken, any data to be returned, and an error checking field.

Address	Function Code	Data	Checksum
(1 byte)	(1 byte)	(0 to 252 bytes)	(2 bytes)

Address specifies the address of the receiver.

Function Code specifies the message type.

Data is the data block.

Checksum specifies the numerical check value for testing the validity of the protocol.

4.2.1. Address

The first byte of information in the message structure of Modbus is the receiver's address. The valid addresses are in the range of 0 to 247. Addresses from 1 to 247 are given to individual Modbus devices and 0 is used for broadcast.

Reference	Description
0xxxx	<u>Read/Write Discrete Outputs or Coils.</u> A 0x reference address is used to device output data to a digital output channel.
1xxxx	<u>Read Discrete Inputs.</u> The ON/OFF status of a 1x reference address is controlled by the corresponding digital input channel.
3xxxx	<u>Read Input Registers.</u> A reference register contains a 16-bit number received from an external source --- e.g. an analog signal.
4xxxx	<u>Read/Write Output or Holding Registers.</u> A 4x register is used to store 16-bits of numerical dada (binary or decimal), or to send the data from the CPU to an output channel.

4.2.2. Function Codes

The second byte in the frame structure is the function code. The function code describes what the slave is required to do. Valid function codes are between 1 and 255. The slave uses the same function code as the request to answer it. Only when error occurs in the system, the highest bit of the function code will be made '1'. Hence the master will know if the message has been transmitted correctly or not.

Code	Function	Reference
01 (01H)	Read Coils (Output) Status	0xxxx
02 (02H)	Read Input Status	1xxxx
03 (03H)	Read Holding Registers	4xxxx
04 (04H)	Read Input Registers	3xxxx
05 (05H)	Force Single Coil (Output)	0xxxx
06 (06H)	Preset Single Register	4xxxx
15 (0FH)	Force Multiple Coils (Outputs)	0xxxx
16 (10H)	Preset multiple Registers	4xxxx

4.2.3. Data Field

The data field consists of messages sent between master and slave. The messages contain additional information about the action to be taken by the slave or any information requested by the slave. When the slave does not require this information the data field can be nonexistent.

4.2.4. Error Check

The error check performed in Modbus/RTU is Cyclic Redundancy Check (CRC). Both the transmitting device and the receiver compute CRC. Two bytes are used for this purpose and generally one bit errors are detected by this method.

4.3. Modbus Register Map

4.3.1. Read/Write Coils (0xxxx)

Begin address	Points	Description	Registers per Point	Range	Access Type
0	0 ~ 31 (32)	Digital Out	1	0 = off 1 = on	R/W
32	1	Clear all DI latched High	1	1 = clear	W (Pulse)
33	1	Clear all DI latched Low	1	1 = clear	W (Pulse)
34	0 ~ 15 (16)	Clear low speed (100 Hz) Digital Counter (single)	1	1 = clear	W (Pulse)
49 ~ 97		Reserved			
98	0 ~ 31	Clear DI Latch High (single)	1	1 = clear	W (Pulse)
130	0 ~ 31	Clear DI Latch Low (single)	1	1 = clear	W (Pulse)
162	0 ~ 31	Clear AI latch High (single)	1	1 = clear	W (Pulse)
194	0 ~ 31	Clear AI latch Low (single)	1	1 = clear	W (Pulse)
210 ~ 225	16	Reserved			
226	1	Recover all I/O default settings	1	1 = clear	W (Pulse)
233	1	Reboot PET-7000/ET-7000	1	1 = reboot	W (Pulse)
250	0 ~ 89 (90)	DO mapping address for external Modbus devices	1	0 = off 1 = on	R/W
340 ~ 346	7	Reserved			
347	1	Enable the average value	1	0 = disable	R/W/E

Begin address	Points	Description	Registers per Point	Range	Access Type
		of the previous AI values of one channel for all AI		1 = enable (Default = 0)	
348	1	Enable Average of all enabled channel, High/Low Alarm value of all AI average value and Average latched values for all AI channels	1	0 = disable 1 = enable (Default = 0)	R/W/E
349	1	Save Module Nick Name to EEPROM	1	1 = write	W/E (Pulse)
350	1	Enable all DI latch latched status (high/low)	1	0 = disable 1 = enable (Default = 0)	R/W/E
351	0 ~ 15	Enable low speed (100Hz) digital counter	1	0 = disable 1 = enable (Default = 0)	R/W/E
365 ~ 427		Reserved			
429	1	DI inverse enable	1	0 = disable 1 = enable (Default = 0)	R/W/E
430	1	DO inverse enable	1	0 = disable 1 = enable (Default = 0)	R/W/E
431	1	Write DO Power on value to EEPROM	1	1 = write	W (Pulse)
432	1	Write DO Safe value to EEPROM	1	1 = write	W (Pulse)
435	0 ~ 79 (80)	Power on value for DO	1	0 = off 1 = on (Default = 0)	R/W/E
515	0 ~ 79 (80)	Safe value for DO	1	0 = off 1 = on (Default = 0)	R/W/E
595	0 ~ 31 (32)	Enable/Disable AI channel	1	0 = disabled 1 = enabled	R/W/E

Begin address	Points	Description	Registers per Point	Range	Access Type
				(Default = 1)	
628	1	Normal/Fast mode for AI	1	0 = normal (16 bit) 1 = fast (12 bit) (Default = 0)	R/W/E
629	1	50/60 Hz rejection for AI	1	1 = 50 Hz 0 = 60 Hz (Default = 0)	R/W/E
630	1	Write DI counter preset value to EEPROM	1	1 = write	W (Pulse)
631	1	AI data format	1	1 = engineering 0 = hex (Default = 0)	R/W/E
632	1	Return the factory calibration (ALL)	1	1 = clear	R/ W (Pulse)
633		Reserved			
634	1	Clear AI Latch High (ALL)	1	1 = Clear	W (Pulse)
635	1	Clear AI Latch Low (ALL)	1	1 = Clear	W (Pulse)
636	0 ~ 31 (32)	AI Alarm High Switch	1	0 = Disabled 1 = Enabled	R/W/E
668	0 ~ 31 (32)	AI Alarm Low Switch	1	0 = Disabled 1 = Enabled	R/W/E
700	0 ~ 31 (32)	AI Alarm High Mode	1	0 = Moment 1 = Latched	R/W/E
732	0 ~ 31 (32)	AI Alarm Low Mode	1	0 = Moment 1 = Latched	R/W/E
764	0 ~ 31 (32)	AI Alarm High	1	0 = OK 1 = alarm (Clear)	R/W (Pulse)
796	0 ~ 31 (32)	AI Alarm Low	1	0 = OK 1 = alarm (Clear)	R/W (Pulse)
828	1	High Alarm of Average value of all AI channel	1	0 = OK 1 = alarm	R/W (Pulse)

Begin address	Points	Description	Registers per Point	Range	Access Type
				(Clear)	
829	1	Low Alarm of Average value of all AI channel	1	0 = OK 1 = alarm (Clear)	R/W (Pulse)
830	1	Enable/Disable calibration	1	0 = disable 1 = enable	R/W
831	1	Zero calibration channel 0	1	1 = write	W (Pulse)
832	1	Span calibration channel 0	1	1 = write	W (Pulse)

4.3.2. Read/Write Discrete Outputs or Coils (1xxxx)

Begin Add.	Points	Description	Registers per Point	Range	Access Type
0	0 ~ 31 (32)	Digital Out	1	0 = off 1 = on	R
32	0 ~ 31 (32)	Digital latched status (high)	1	0 = no 1 = latched	R
64	0 ~ 31 (32)	Digital latched status (low)	1	0 = no 1 = latched	R
65 ~ 303		Reserved			
304	0 ~ 31 (32)	Break line status of AI registers	1	0 = ok 1 = break	R
336	1	High alarm for the average value of all AI registers	1	0 = ok 1 = alarm	R
337	1	Low alarm for the average value of all AI registers	1	0 = ok 1 = alarm	R
338	0 ~ 11	Reserved			
350	0 ~ 89 (90)	DI mapping address for external Modbus devices	1	0 = off 1 = on	R
440	0 ~ n	Reserved			

4.3.3. Read Input Registers (3xxxx)

Begin address	Points	Description	Registers per Point	Range	Access Type
0	0 ~ 31 (32)	Analog Input	Word	-32768 ~ +32767	R
32 ~ 63	0~31 (32)	DI Counter Value	Word	0 ~ 65535	R
64 ~ 143		Reserved			
144	0 ~ 31	Average value of one channel	Word	0 ~ 65535 or -32768 ~ +32767	R
176	1	Average value of all Enabled AI channel	Word	0 ~ 65535 or -32768 ~ +32767	R
177	1	Average value of all Max. Latched AI value	Word	0 ~ 65535 or -32768 ~ +32767	R
178	1	Average value of all Min. Latched AI value	Word	0 ~ 65535 or -32768 ~ +32767	R
180	0 ~ 49 (50)	AI mapping address for external Modbus devices	Word	0 ~ 65535 or -32768 ~ +32767	R
230 ~ 235		Reserved			
Analog Latched value					
236	0 ~ 31 (32)	Analog Latched value (High)	Word	0 ~ 65535 or -32768 ~ +32767	R
268	0 ~ 31 (32)	Analog Latched value (Low)	Word	0 ~ 65535 or -32768 ~ +32767	R
Channel number for DI registers					
300	1	DI (Channel number)	Word	0 ~ 32	R
301	1	DI high/low latch (Channel number)	Word	0 ~ 32	R
302 ~ 309		Reserved			
Channel number for DO registers					
310	1	DO (Channel number)	Word	0 ~ 79	R
311	1	Power on value for DO (Channel number)	Word	0 ~ 79	R

312	1	Safe value for DO (Channel number)	Word	0 ~ 79	R
313 ~ 319		Reserved			
Channel number for AI registers					
320	1	AI (Channel number)	Word	0 ~ 16	R
321	1	Low speed counter (100Hz) (Channel number)	Word	0 ~ 16	R
322 ~ 329		Reserved			
Channel number for AO registers					
330	1	AO (Channel number)	Word	0 ~ 16	R
Version information					
350	1	OS image version	Word	123 means version = 1.2.3	R
351	1	Total Firmware version	Word	123 means version = 1.2.3	R
352	1	CPU lib version	Word	123 means version = 1.2.3	R
353	1	I/O firmware version	Word	123 means version = 1.2.3	R
354	1	MFW lib version	Word	123 means version = 1.2.3	R
355	1	TCP/IP lib version	Word	123 means version = 1.2.3	R
356	1	Modbus lib version	Word	123 means version = 1.2.3	R
357	1	Web lib version	Word	123 means version = 1.2.3	R
358	1	Modbus communication status	Word	0 = No Error -1 = CRC error -2 = Timeout	R
359	1	Reserved	Word		
360	1	Pair Connection	Word	0 = Normal 1 = Timeout 2 = Disconnected	R
371	1	Software protection	Word		R

		CRC16			
372	0 ~ 7 (8)	COM1 ~ COM8 communication status for Modbus mapping	Word	1: CRC error -2: Receiving response timeout 0 ~ 255: Exception code 500: busy 501: Command not sent yet. 502: Command already sent, but no data received. 503: not match parameters	R
373 ~	0 ~ n	Reserved			

4.3.4. Read/Write Output or Holding Registers (4xxxx)

Begin address	Points	Description	Data Type (per Point)	Range	Access Type
0	32	Analog Output	Word	-32768 ~ +32761	R/W
32 ~ 58		Reserved			
59	1	Average times for every channel	Word	0 ~ 40	R/W/E
60	0 ~ 49 (50)	AO mapping address for external Modbus devices	Word	0x0000 ~ 0xFFFF	R/W/E
92 ~ 173		Reserved			
174	1	Enable/Disable AI channel	Word	0 ~ 65535	R/W
176 ~ 197		Reserved			
198	1	High alarm value for Average value of all AI channel	Word	0 ~ 65535 or -32768 ~ +32767	R/W/E
199	1	Low alarm value for Average value of all AI channel	Word	0 ~ 65535 or -32768 ~ +32767	R/W/E
DI Counter					
200	0 ~ 31	DI preset count	Word	0 ~ 65535	R/W/E
232	0 ~ 31	Current AO Read back	Word	-32768 ~ +32761	R
263 ~ 270		Reserved			
271	1	Modbus Address Net ID	Word	1 ~ 255	R/W/E
272 ~ 295		Reserved			

296	0 ~ 31 (32)	High alarm value for AI	Word	-32768 ~ +32767 (Default = 32767)	R/W/E
328	0 ~ 31 (32)	Low alarm value for AI	Word	-32768 ~ +32767 (Default = -32768)	R/W/E
360	0 ~ 31 (32)	AO power on value	Word	-32768 ~ +32767 (Default = 0)	R/W/E
392	0 ~ 31 (32)	AO safe value	Word	-32768 ~ +32767 (Default = 0)	R/W/E
424 ~ 426		Reserved			
427	0 ~ 31 (32)	Type code for AI	Word	Refer to range code table	R/W/E
459	0 ~ 31 (32)	Type code for AO	Word	Refer to range code table	R/W/E
491 ~ 522		Reserved			
523	0 ~ 31	AO slew rate	Word		R/W
555	1	CPU reset status	Word	1 = by power on 2 = by 0.8 second WDT 3 = by Reset command	R/W

556	1	CPU reset events	Word	How many CPU reset events has happened? When CPU is reset by one of the situations described in register 555, the event increases one count.	R/W/E
557	1	Set host watch dog timer	Word	<5: Disabled 5 ~ 65535: Enabled (Unit: second) (Default = 0) When PET-7000/ET-7000 loses communication with PC more than the WDT setting, DO and AO go to their safe values and host WDT events plus 1 count.	R/W/E
558	1	Host WDT events	Word	How many host WDT events have happened after CPU reset?	R/W
559	1	Module name	4 word	16 ASCII characters	R
563	1	Module nick name	8 word	16 ASCII characters	R/W

572	1	Station per COM port	Word	1 ~ 255	R/W/E
573	0 ~ 7 (8)	COM port enable mode	Word	0 ~ 5	R/W/E
581	0 ~ 7 (8)	COM port Communication Timeout	Word	10 ~ 65535 (ms)	R/W/E
589	0 ~ n	Reserved			
590	0 ~ 31 (32)	AO Calibration zero trim	Word	+/- 0x005F 0x005F ~ 0xFFA1	W
622	0 ~ 31 (32)	AO Calibration span trim	Word	+/- 0x005F 0x005F ~ 0xFFA1	W
652	0 ~ n				

Chapter 5. MiniOS7 Utility Tool

MiniOS7 Utility is a tool for uploading firmware to flash memory and updating the OS to PET-7000/ET-7000 module embedded with ICP DAS MiniOS7 with easiness and quickness.

If you don't have the MiniOS7 Utility installed on your system, installation of the MiniOS7 Utility should be the first step. Please refer to section "2.4. Installing the MiniOS7 Utility" to install it.

5.1. Establishing a Connection

To upload firmware or update the OS to PET-7000/ET-7000 module, you must first establish a connection between PC and the PET-7000/ET-7000 module.

Step 1: Run the MiniOS7 Utility

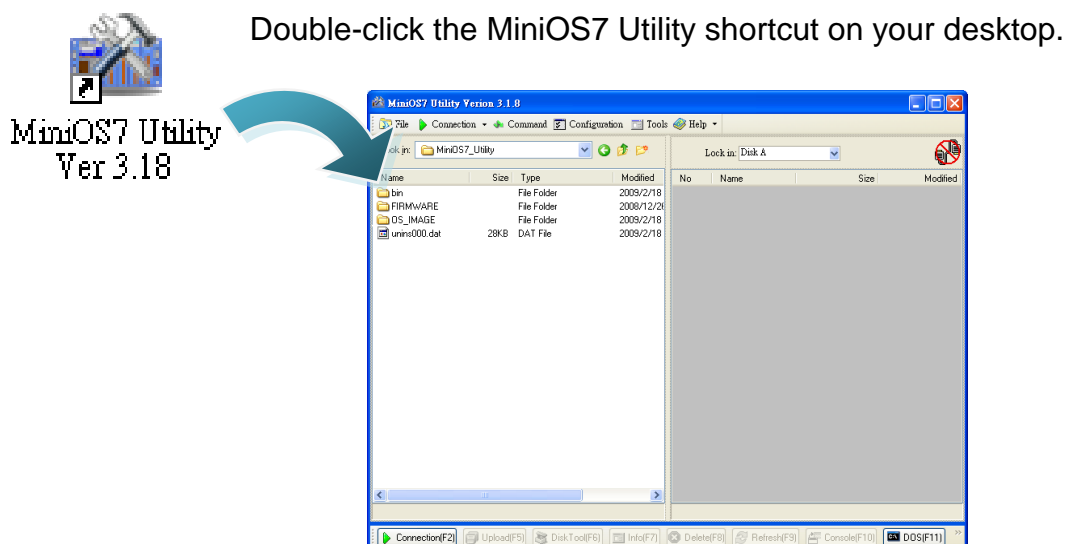

Step 2: Press “F12” or choose “Search” from the “Connection” menu

After pressing **F12** or choosing **Search** from **Connection** menu, that will search all of the MiniOS7 modules on your network.

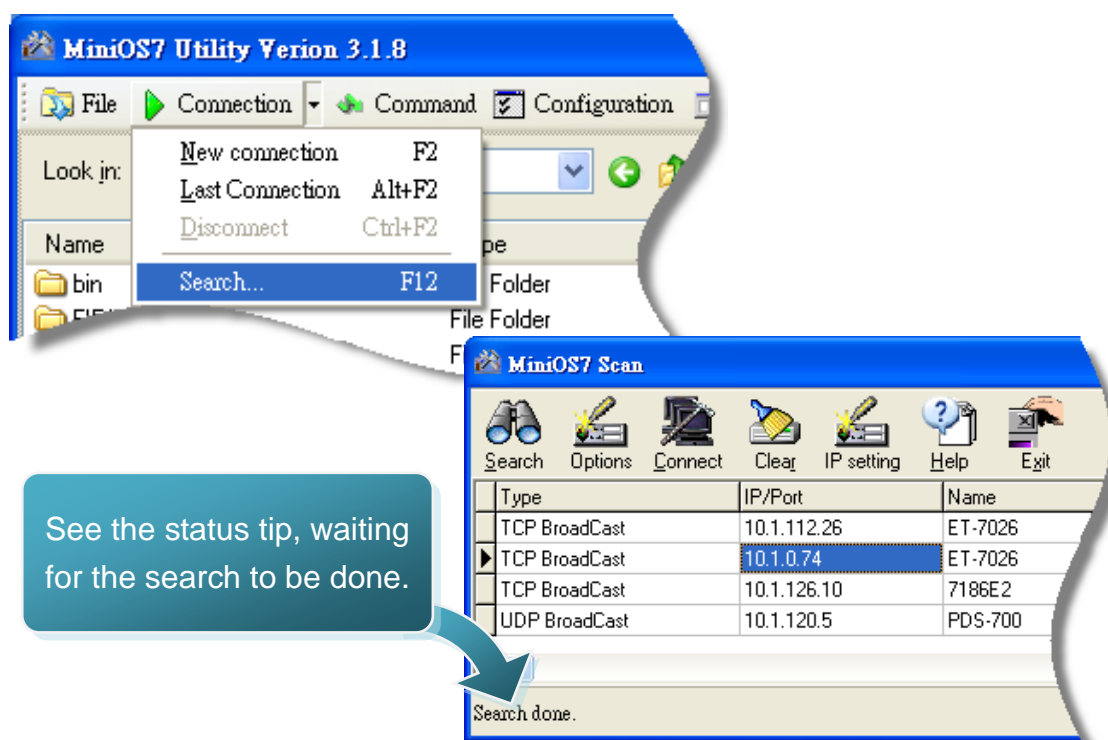

Step 3: Double-Click the field of your PET-7000/ET-7000 module

Double-Click the field of your PET-7000/ET-7000 module in the list to connect to your PET-7000/ET-7000.

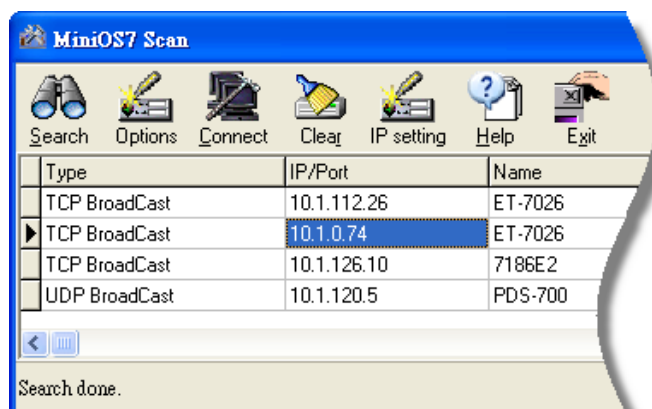

Step 4: The connection has ready been established

Check the connection status in the top right side to make sure the connection has been established

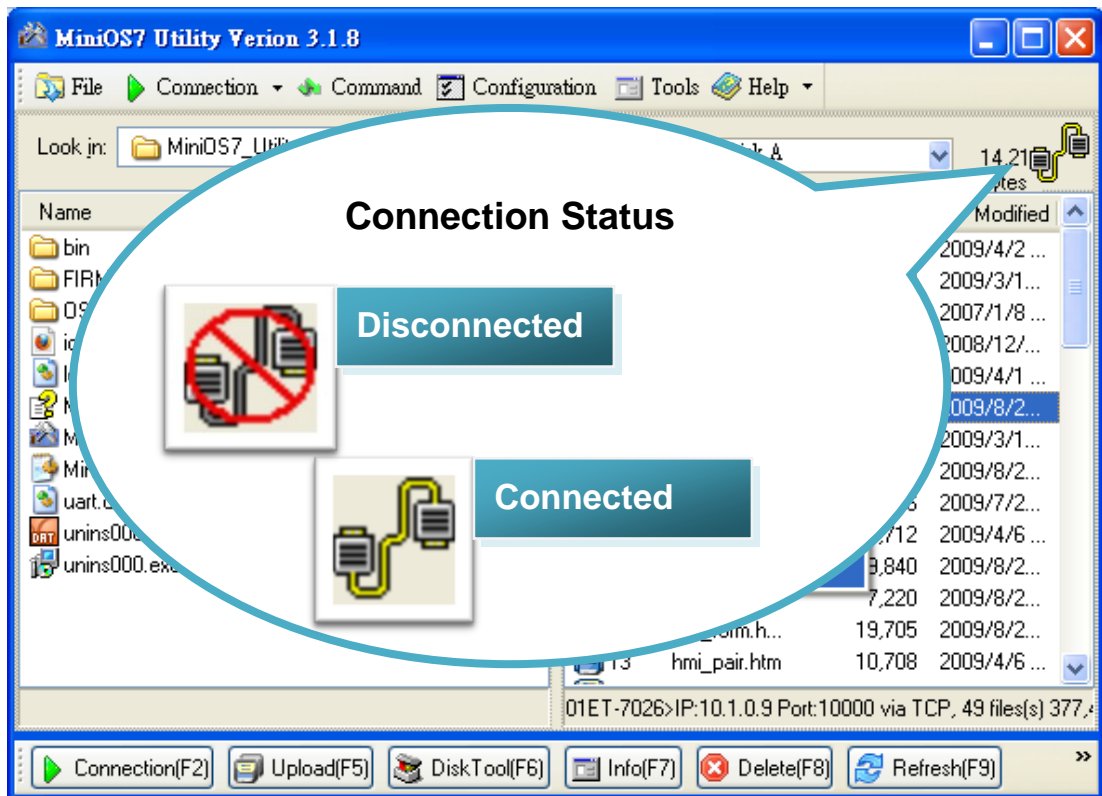

5.2. Exchanging the Protocol (TCP/IP to UDP)

MiniOS7 Utility supports both UDP and TCP protocols.

For MiniOS7 Utility, the TCP/IP is the default protocol for communicating with PET-7000/ET-7000, and the UDP is used to update the OS. Therefore, if you want to update the OS, you might need to change protocols to support them.

Step 1: Establish a connection to PET-7000/ET-7000

For more detailed about this process, please refer to section “5.1. Establishing a Connection” to establish a connection.

Step 2: Right Click the file list of the right side window, and then choose “Quit Firmware” to stop the firmware running

Right click the file list of the right side windows, and then choose **Quit Firmware** to stop the firmware running and exchange TCP/IP protocol to UDP protocol.

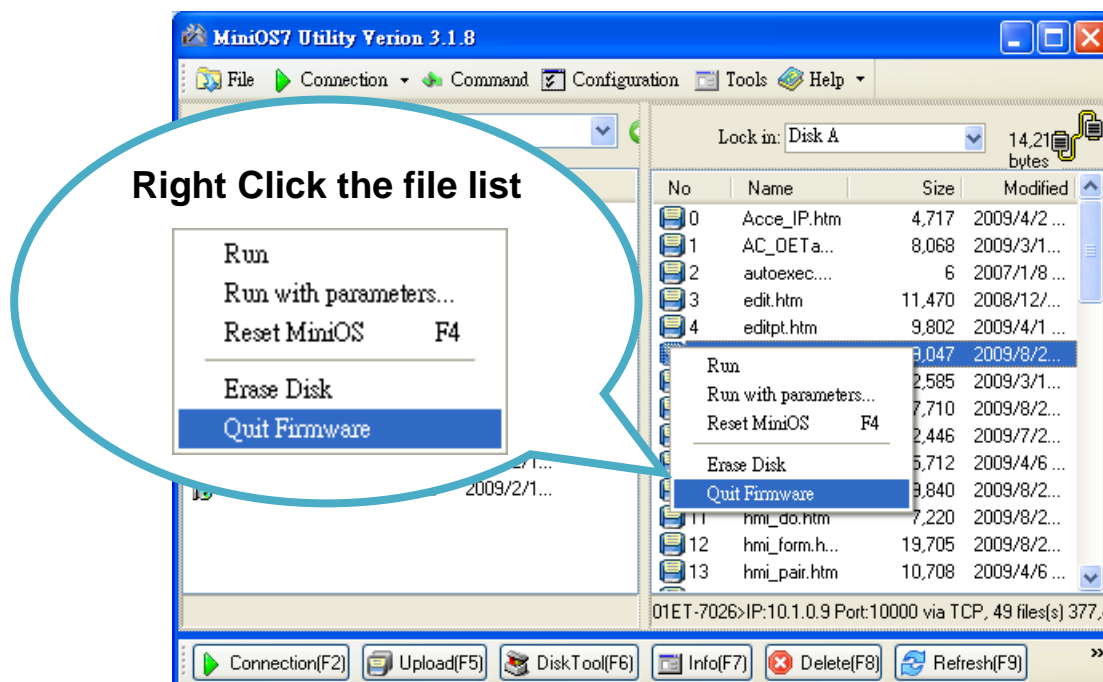

Step 3: Click “Yes” to continue

After executing the **Quick Firmware** command, the Confirm dialog will appear, and then click **Yes** button to continue and stop the firmware running.

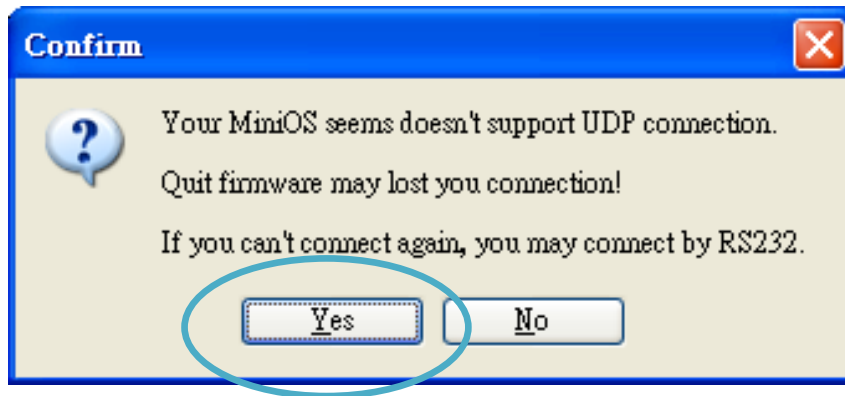

Step 4: Click “Yes” to continue

After confirming the command, the Confirm dialog will appear, and then click **Yes** button to exchange UDP protocol for TCP protocol.

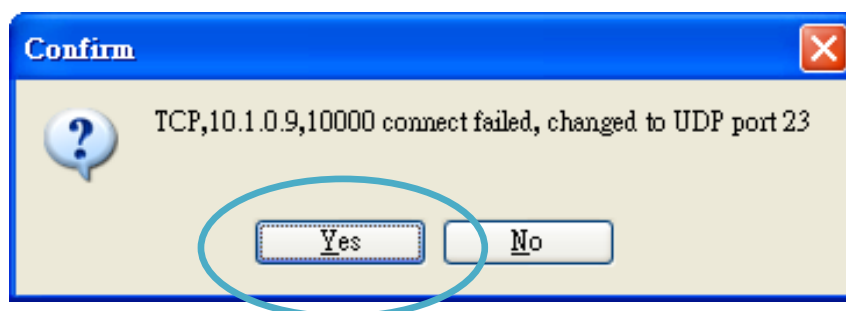

Step 5: The changes have been affected

5.3. Updating the PET-7000/ET-7000 OS

ICP DAS will continue to add additional features to PET-7000/ET-7000 OS in the future, so we advise you to periodically check the ICP DAS web site for the latest updates.

Step 1: Get the latest version of the MiniOS7 OS image

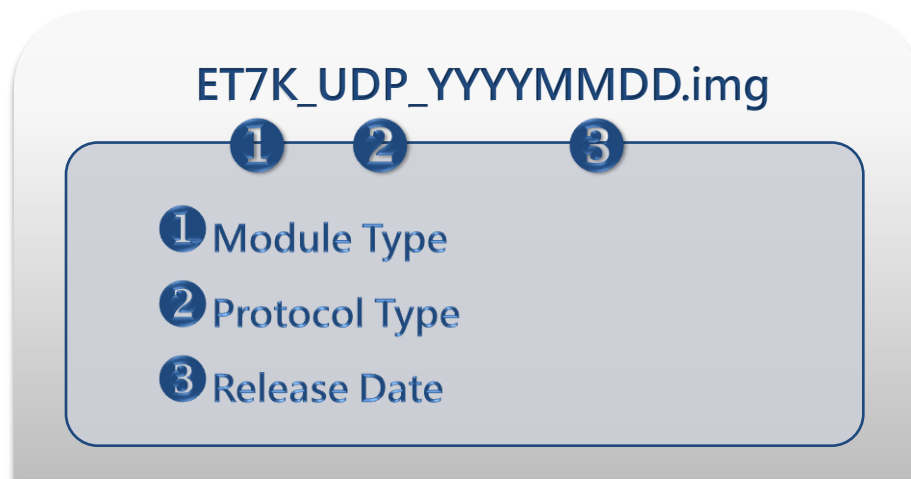

The latest version of the MiniOS7 OS image can be obtained from:
CD:\NAPDOS\ET7000\OS_image\
http://ftp.icpdas.com/pub/cd/6000cd/napdos/et7000/os_image/

Step 2: Turn the switch to “Init” position

Turn the Init/Normal switch to **Init** position.

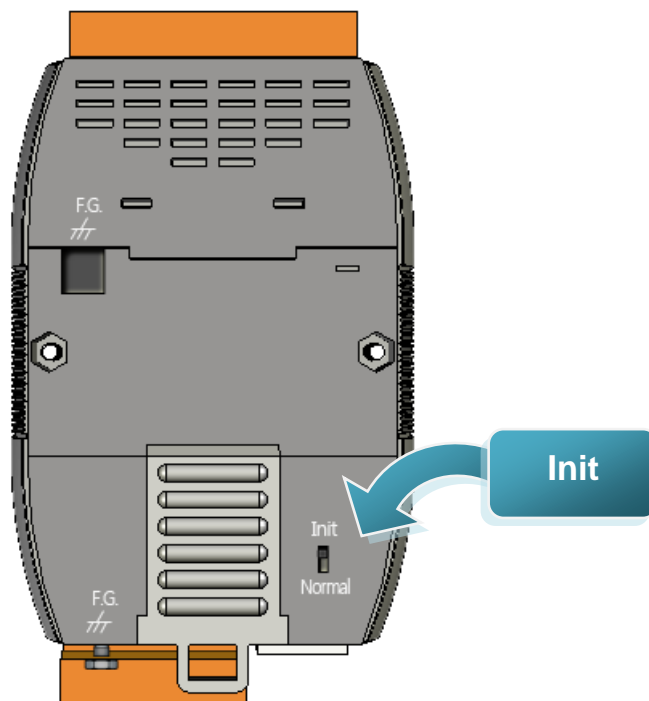

Step 3: Establish a connection to PET-7000/ET-7000

For more detailed about this process, please refer to section “5.1. Establishing a Connection” to establish a connection.

Step 4: Exchange the protocol

For more detailed about this process, please refer to section “5.2. Exchanging the Protocol (TCP/IP to UDP)” to exchange the protocol.

Step 5: Choose “Update MiniOS7 Image” from the “File” menu

After exchanging the protocol, then choose **Update MiniOS7 Image** from **File** menu to start the update procedure.

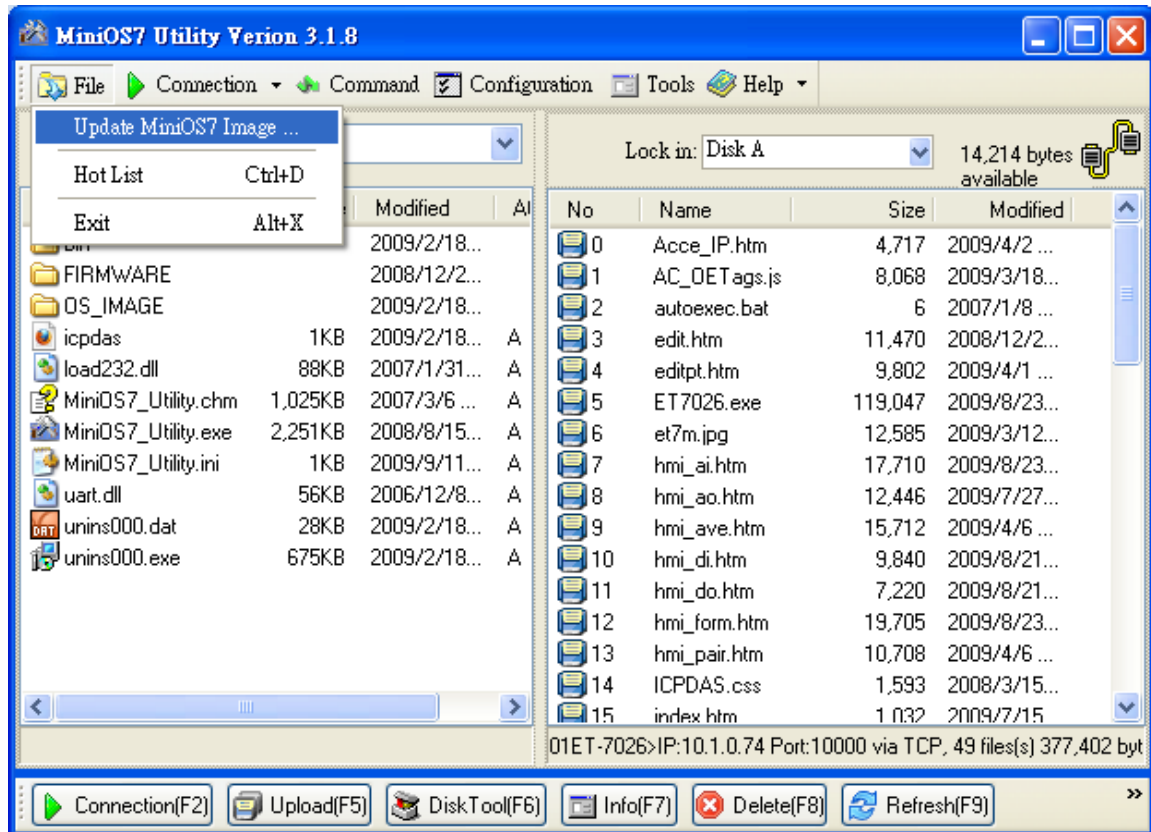

Step 6: Select the latest version of the MiniOS7 OS image

After choosing the **update MiniOS7 Image** command, the Select MiniOS7 Image file will appear, and then select the latest version of the MiniOS7 OS image.

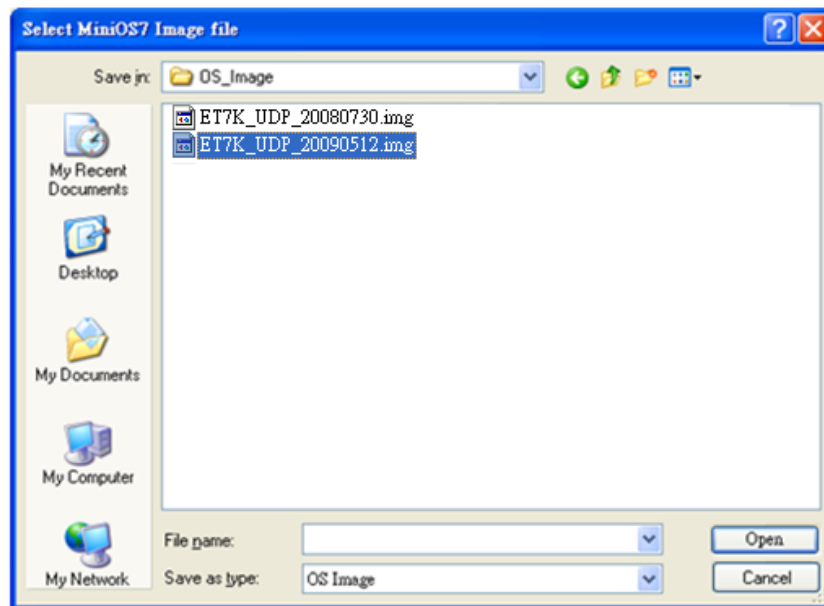

Step 7: Click “OK” to finish the procedure

After confirming the command, you just need to wait awhile until the following dialog appear, and then click **OK** button to finish the procedure.

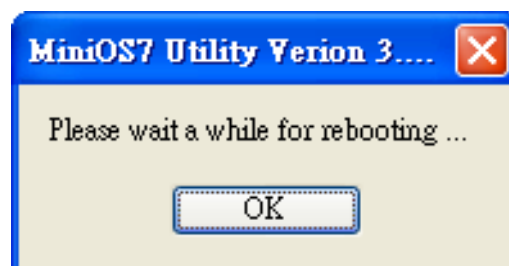

Step 8: Restart the MiniOS7 Utility, and then exchange the protocol to UDP

You may need to restart the MiniOS7 Utility for refreshing the settings, and then exchanging the protocol to UPD

For more detailed about this process, please refer to section “5.2.

Exchanging the Protocol (TCP/IP to UDP)” to exchange the protocol.

Step 9: Press “F7” or choose “Info” from the “Command” menu to check the OS version

After pressing F7 or choosing **info** from **Command** menu to check the OS version.

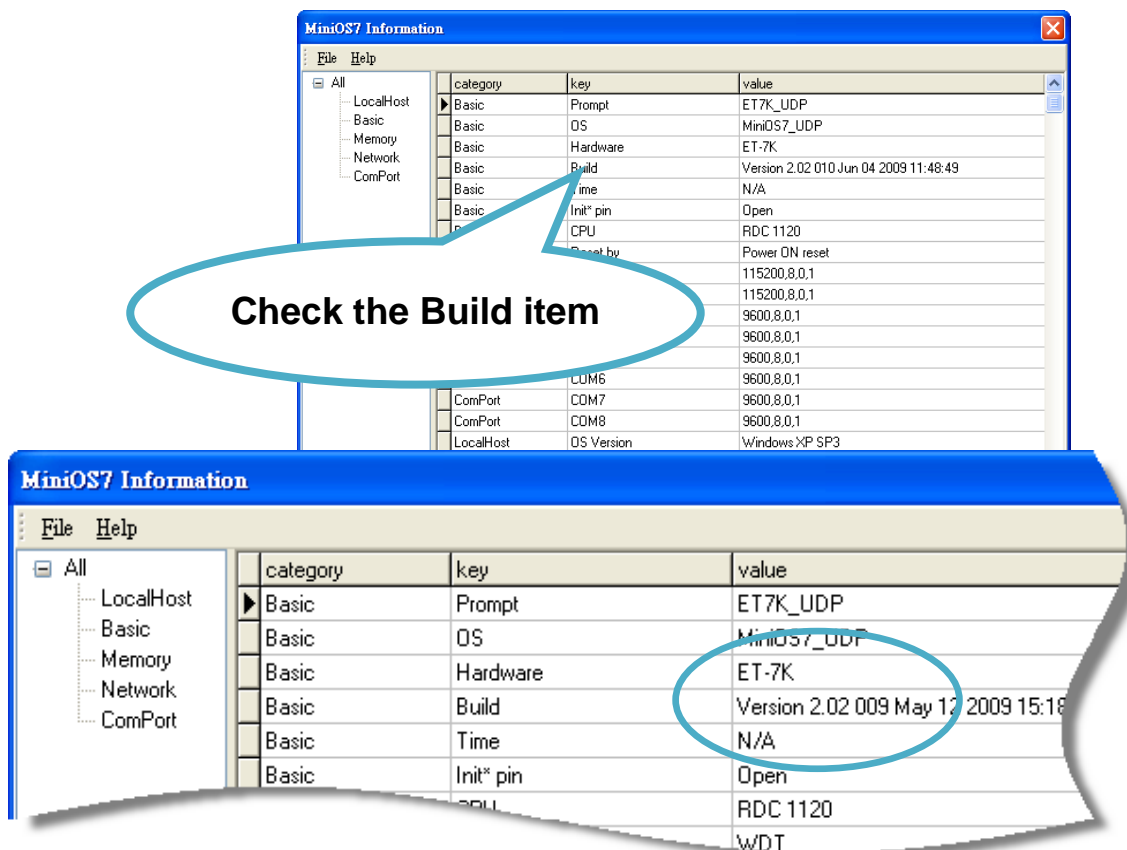

5.4. Uploading the PET-7000/ET-7000 Firmware

The firmware is stored in flash memory and can be updated to fix functionality issues or add additional features, so we advise you to periodically check the ICP DAS web site for the latest updates.

Step 1: Get the latest version of the MiniOS7 firmware and the autoexec.bat file

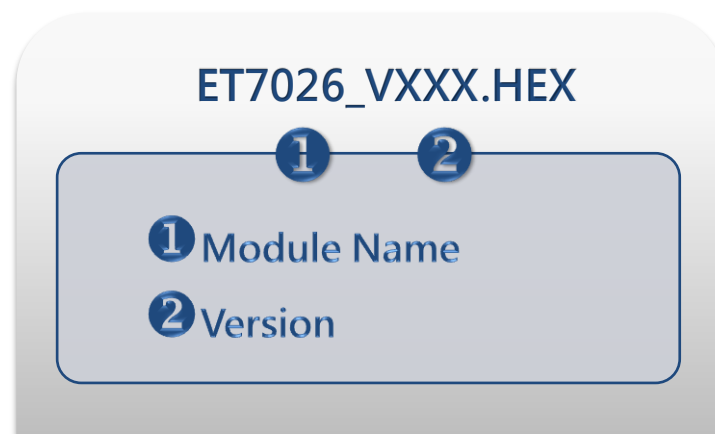

The latest version of the MiniOS7 firmware and autoexec.bat file can be obtained from:

CD:\NAPDOS\ET7000\Firmware\

<http://ftp.icpdas.com/pub/cd/6000cd/napdos/et7000/Firmware/>

Step 2: Turn the switch to “Init” position

Turn the Init/Normal switch to **Init** position.

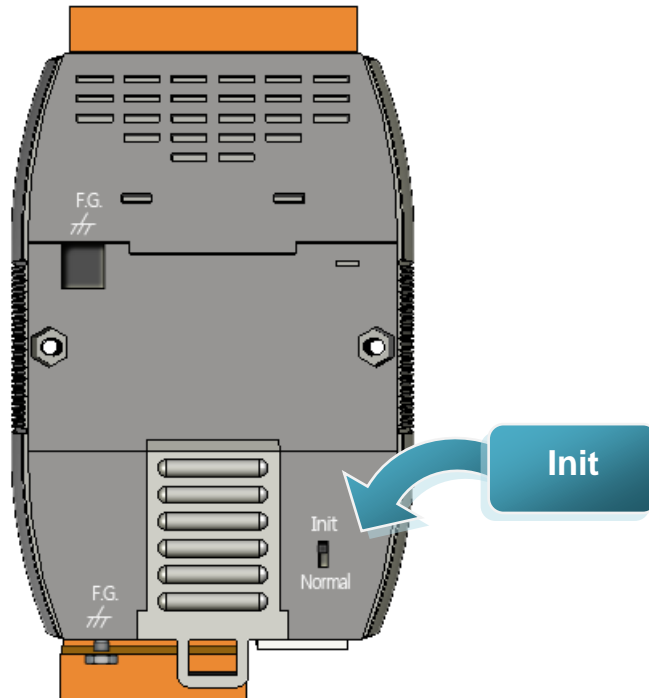

Step 3: Establish a connection to PET-7000/ET-7000

For more detailed about this process, please refer to section “5.1. Establishing a Connection” to establish a connection.

Step 4: Choose “Erase Disk” from the “Command” menu

After establishing a connection, then choose **Erase Disk** from **Command** menu to erase the contents of the flash memory.

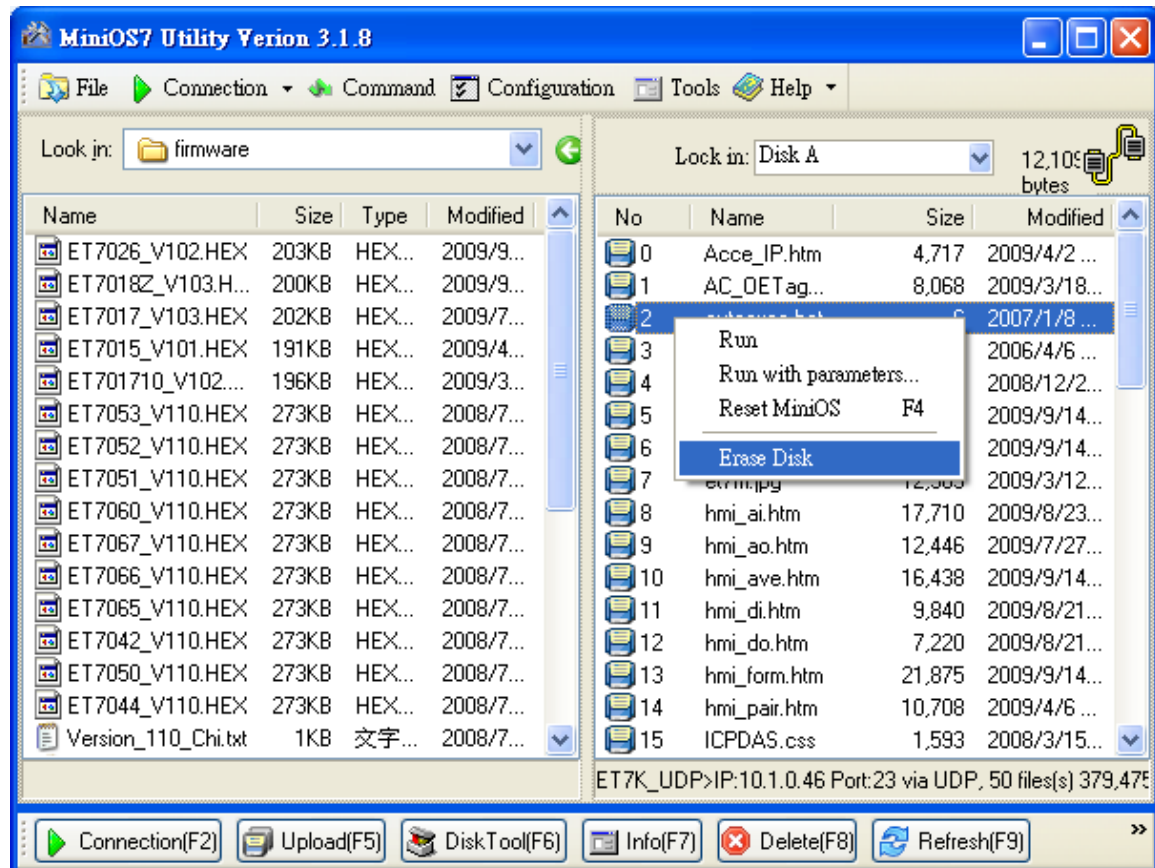

Tips & Warnings



You have to delete all files existed on the PET-7000/ET-7000 before uploading the firmware.

Step 5: Click “Yes” to continue

After executing the **Erase Disk** command, the Confirm dialog will appear, and then click Yes button to continue erasing the memory contents.

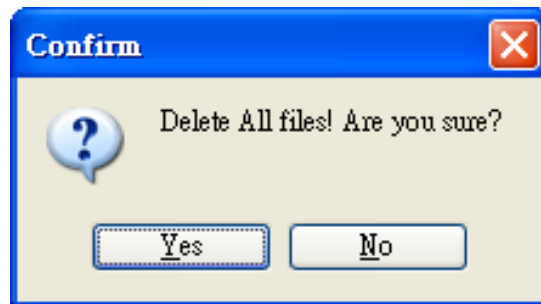

Step 6: Select the latest version of the MiniOS7 firmware and autoexec.bat file

After confirming the command, all files of the PET-7000/ET-7000 will be deleted. Select MiniOS7 Image file will appear, and then select the latest version of the MiniOS7 OS image.

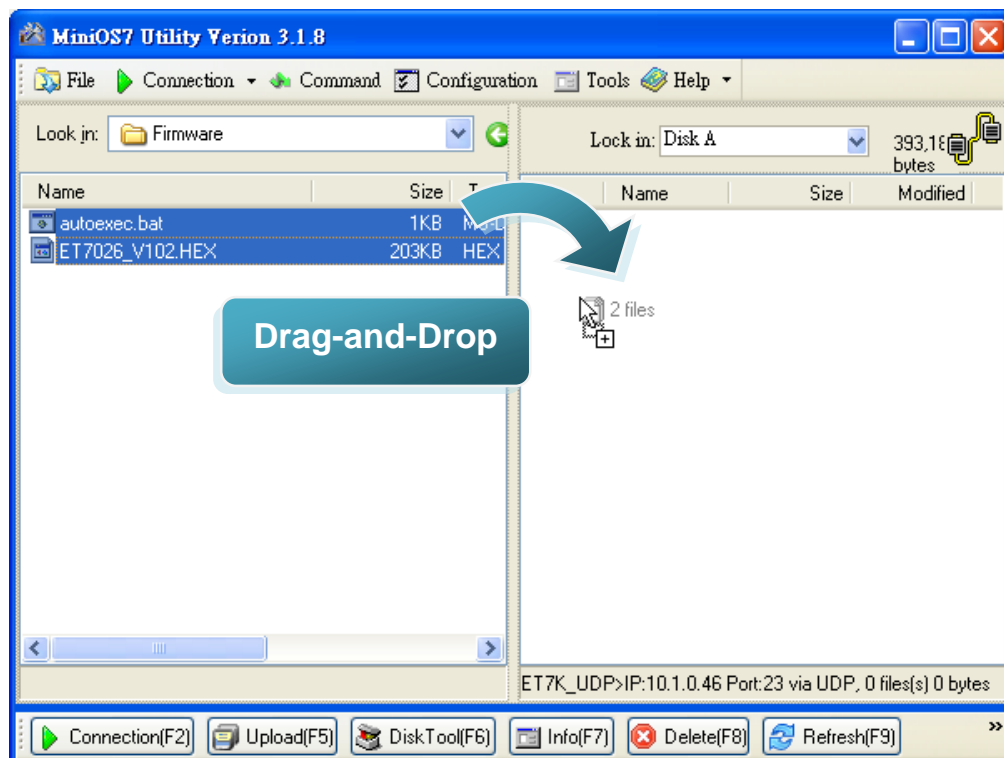

Step 7: Click OK to finish and restart the MiniOS7 Utility

After confirming the command, you just need to wait awhile until the following dialog appear, and then click OK button to finish the procedure.

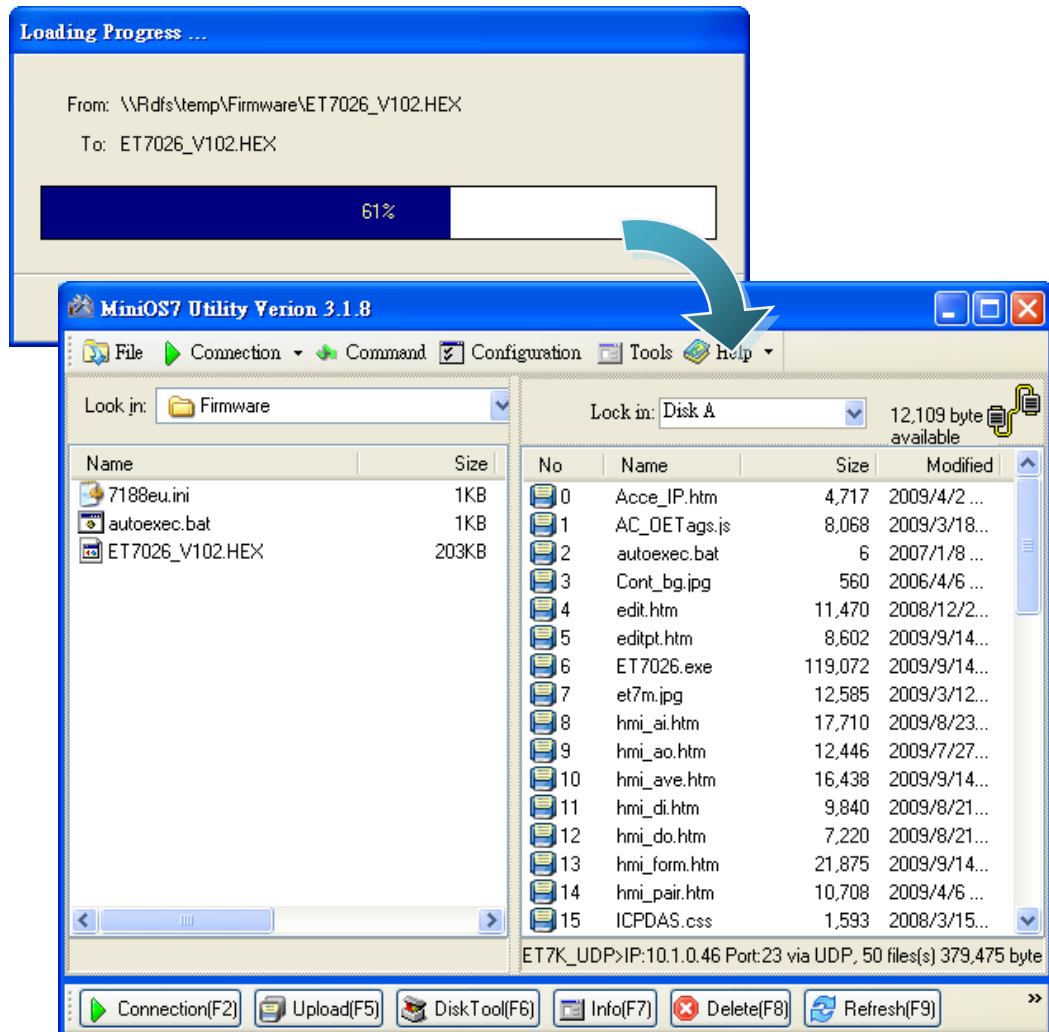

Chapter 6. External Tools and Tasks

6.1. LabVIEW

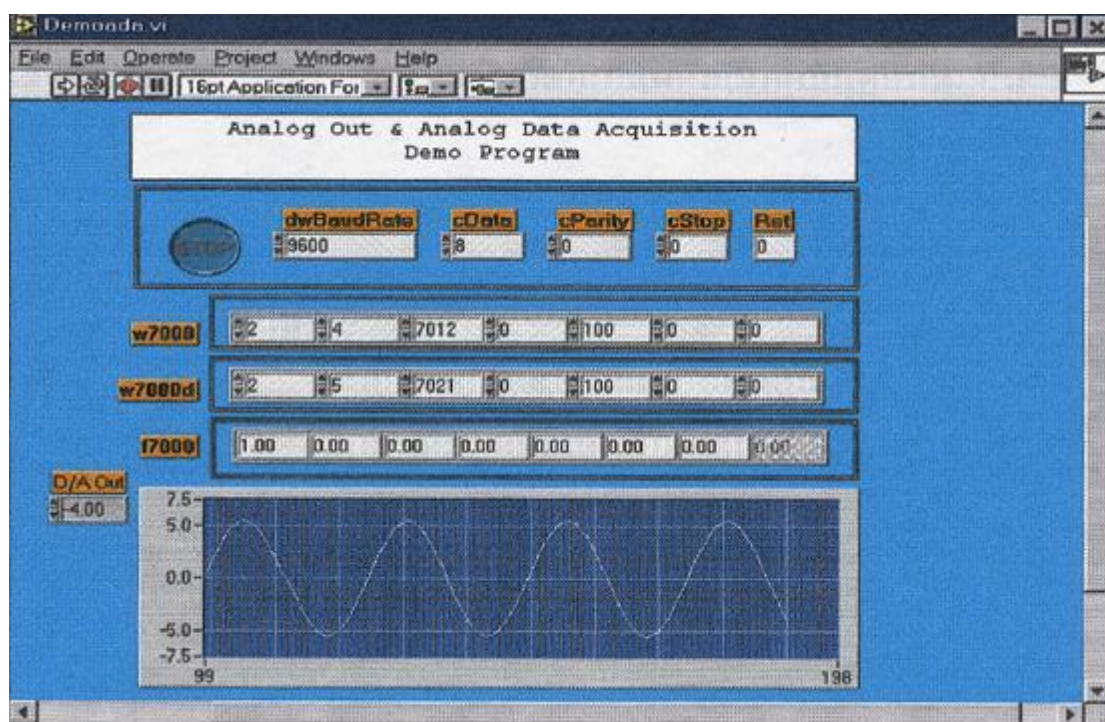

LabVIEW is the best way to acquire, analyze, and present data. LabVIEW delivers a graphical development environment that can be used to quickly build data acquisition quickly, instrumentation and control systems, boosting productivity and saving development time. With LabVIEW, it is possible to quickly create user interfaces that enable interactive control of software systems. To specify your system functionality, simply assemble block diagram – a natural design notation for scientists and engineers.

The document containing the detailed instructions for linking to the PET-7000/ET-7000 using the Modbus protocol is located on the shipped CD:\NAPDOS\PET7000_ET7000\Document\Application\LabVIEW\ or ftp://ftp.icpdas.com/pub/cd/6000cd/napdos/pet7000_et7000/document/application/labview/

6.2. OPC Server

OPC (OLE for Process Control) is the first standard resulting from the collaboration of a number of leading worldwide automation suppliers working in cooperation with Microsoft. Originally based on Microsoft's OLE COM (Component Object Model) and DCOM (Distributed Component Object Model) technologies, the specification defines a standard set of objects, interfaces and methods for use in process control and manufacturing automation applications to facilitate interoperability.

There are many different mechanisms provided by various vendors that allow access to a variety of devices via specific applications. However, if an OPC server is provided for the device, other applications will be able to access the OPC Server via the OPC interface.

6.3. SCADA

SCADA stands for Supervisor Control and Data Acquisition. It is a production automation and control system based on PCs

SCADA is widely used in many fields e.g. power generation, water systems, the oil industry, chemistry, the automobile industry. Different fields require different functions, but they all have the common features:

- ✓ Graphic interface
- ✓ Process mimicking
- ✓ Real time and historic trend data
- ✓ Alarm system
- ✓ Data acquisition and recording
- ✓ Data analysis
- ✓ Report generator

► Accessing PET-7000/ET-7000 module

SCADA software is able to access PET-7000/ET-7000 devices using Modbus communication protocols, and can communicate without the need for other software drivers.

► Famous SCADA software

Citect, ICONICS, iFIX, InduSoft, Intouch, Entivity Studio, Entivity Live, Entivity VLC, Trace Mode, Wizcon, Wonderware ... etc

In the following sections 3 popular brands of SCADA software are introduced together with the detailed instructions in how use them to communicate with PET-7000/ET-7000 series module using the Modbus/TCP protocol.

6.3.1. InduSoft

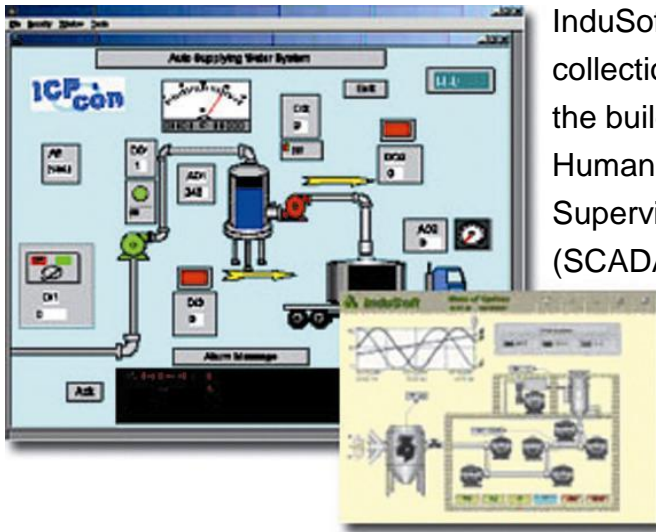

InduSoft Web Studio is a powerful, integrated collection of automation tools that includes all the building blocks needed to develop modern Human Machine Interfaces (HMI), Supervisory Control and Data Acquisition (SCADA) systems, and embedded instrumentation and control applications. InduSoft Web Studio's application runs in native Windows NT, 2000, XP, CE and CE .NET environments and conforms to industry standards such as Microsoft .NET, OPC,

DDE, ODBC, XML, and ActiveX.

The document containing detailed instructions for linking to the PET-7000/ET-7000 module using the Modbus protocol is located on the shipped

CD:\NAPDOS\PET7000_ET7000\Document\Application\InduSoft\

ftp://ftp.icpdas.com/pub/cd/6000cd/napdos/pet7000_et7000/document/application/indusoft/

6.3.2. Citect



CitactSCADA is a fully integrated Human Machine Interface (HMI) / SCADA solution that enables users to increase return on assets by delivering a highly scalable, reliable control and monitoring system. Easy-to-use configuration tools and powerful features enable rapid development and deployment of solutions for any size application.

The document containing detailed instructions for linking to the PET-7000/ET-7000 module using the Modbus protocol is located on the shipped

CD:\NAPDOS\PET7000_ET7000\Document\Application\Citact\

ftp://ftp.icpdas.com/pub/cd/6000cd/napdos/pet-7000_et7000/document/application/citact/

6.3.3. iFix



The document containing detailed instructions for linking to the PET-7000/ET-7000 module using the Modbus protocol is located on the shipped

CD:\NAPDOS\PET7000_ET7000\Document\Application\iFix\

ftp://ftp.icpdas.com/pub/cd/6000cd/napdos/pet7000_et7000/document/application/ifix/

Appendix A. Frame Ground

Electronic circuits are constantly vulnerable to Electro-Static Discharge (ESD), which become worse in a continental climate area. PET-7000/ET-7000 series modules feature a new design for the frame ground, which provides a path for bypassing ESD, allowing enhanced static protection (ESD) capability and ensures that the module is more reliable.

The following options will provide a better protection for the module:

The PET-7000/ET-7000 controller has a metallic board attached to the back of the plastic basket as shown in the figure below, point 1.

When mounted to the DIN rail, connect the DIN rail to the earth ground because the DIN rail is in contact with the upper frame ground as shown in the figure below, point 2.

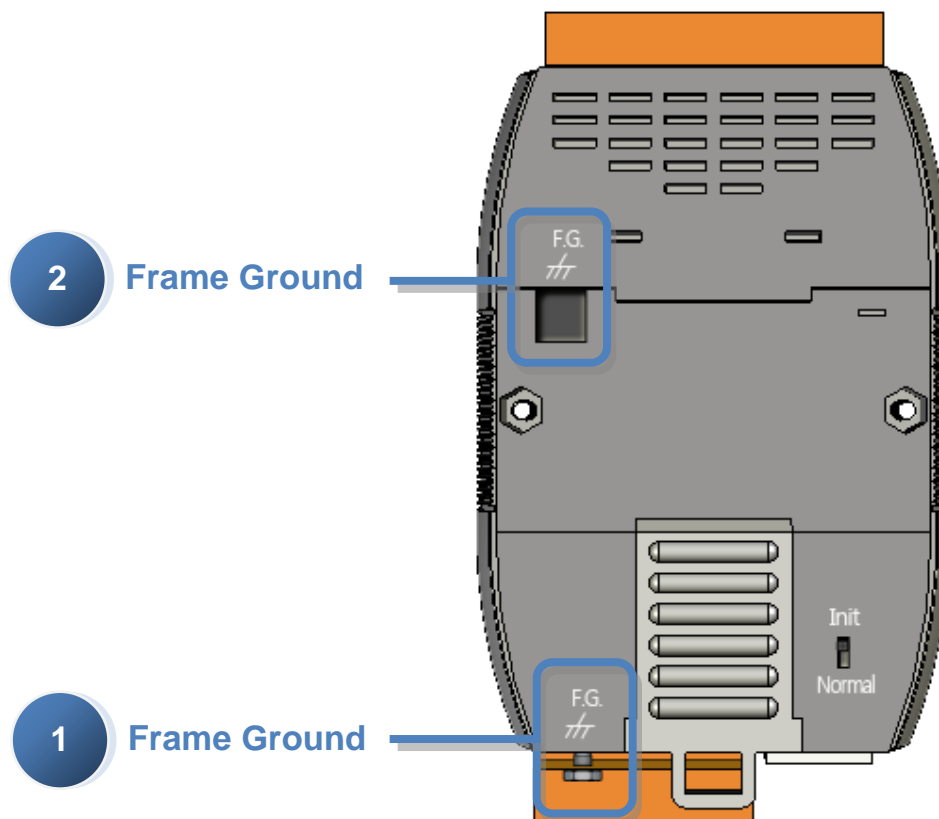

Appendix B. Node Information Area

Each PET-7000/ET-7000 module has a built-in EEPROM to store configuration information such as IP address, type code, etc. One minor drawback is that there are no visual indications of the configuration of the module. New PET-7000/ET-7000 modules include node information areas that are protected by a cover, as shown below, and can be used to make a written record of the node information, such as IP address, etc. To access the node information areas, first slide the covers outward, as shown in the figure below.

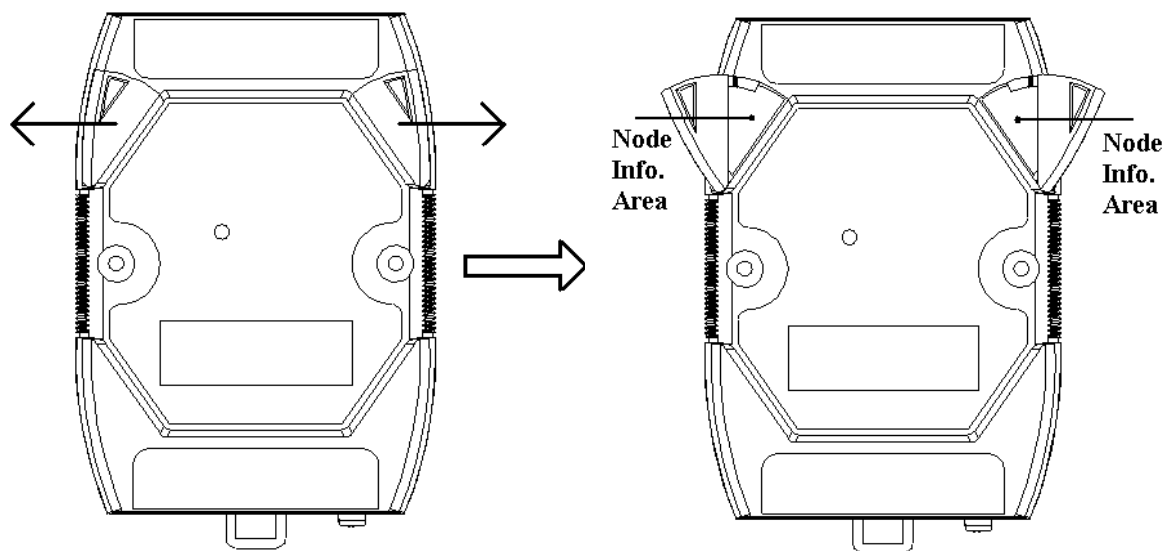

Appendix C. Modbus Application Notes

C.1. Dual Watchdog

Dual Watchdog consists of Module Watchdog and Host Watchdog.

1. The Module Watchdog is a built-in hardware circuit that will reset the CPU module if a failure occurs in either the hardware or the software. If the application does not refresh the watchdog timer within 0.8 seconds, the watchdog circuit will initiate a reset of the CPU.

2. The Host Watchdog is a software function that can be used to monitor the operating status of the host. Its purpose is to prevent network communication problems or a host failure. If the Watchdog timeout interval expires, the module will return all outputs to a predefined Safe value (Refer to the Safe Value application note), which can prevent the controlled target from unexpected situation.

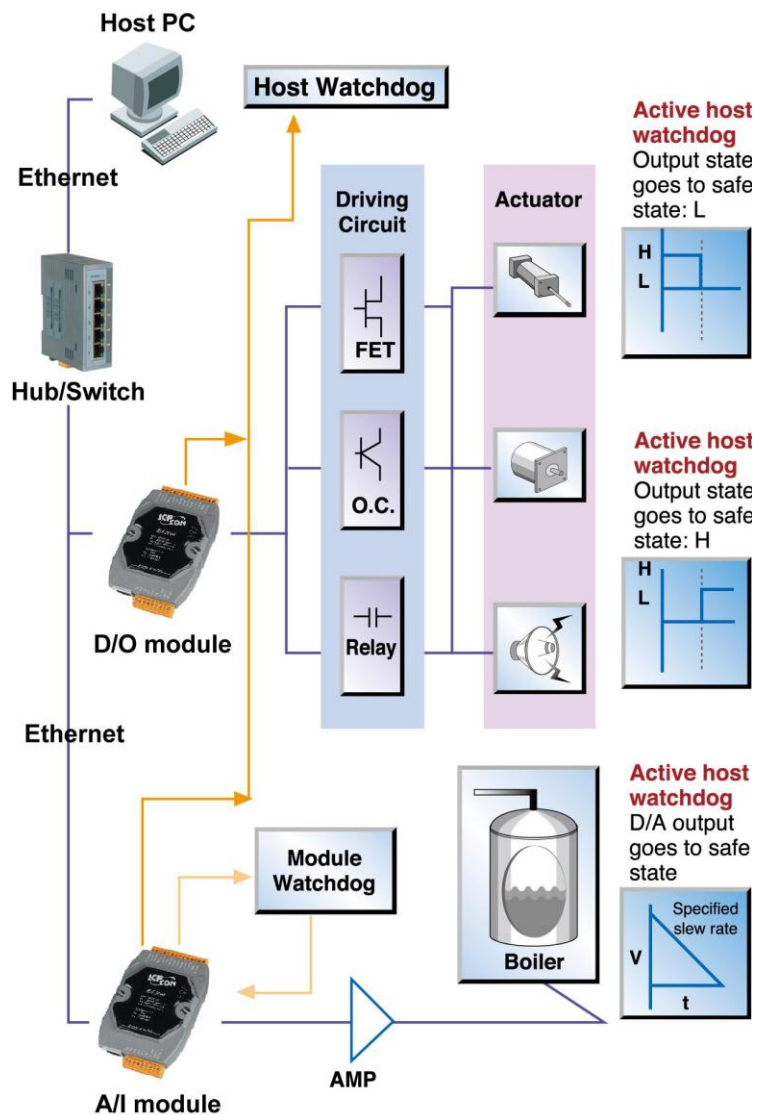

AO address 40557 of the ET-7000/PET-7000 series Modbus register is the address of the Host Watchdog timer, and will be stored into EEPROM. The WDT function will be disabled if the value is set to less than 5 seconds.

C.2. Power ON Value

If the ET-7000/PET-7000 series module is reset, the output of the module is set to the predefined Power ON Value for the DO and AO channels. DO address 00435 of the ET-7000/PET-7000 series Modbus register is the first address of the Power ON value, and the total number of channels depend on the type of module.

For example:

Addresses 00435 to 00438 records the Power ON value for the 4-Channel ET-7017/PET-7017.

Be careful to set the ON value to DO address 00431 to write the DO Power ON value to the EEPROM of the ET-7000/PET-7000 DO module after using Modbus commands (05 or 15) to change the Power ON value.

Configuration via Web page

Browse to the homepage of the ET-7000/PET-7000, and click the “Modbus I/O Settings” link in the Configuration Section of the Main Menu tree.



Modbus Address	Function	Action
435	Power on value for DO	0 OFF <input checked="" type="radio"/> ON <input type="radio"/> 1 OFF <input type="radio"/> ON <input type="radio"/> 2 OFF <input type="radio"/> ON <input type="radio"/> 3 OFF <input type="radio"/> ON <input type="radio"/> 4 OFF <input type="radio"/> ON <input type="radio"/> 5 OFF <input type="radio"/> ON <input type="radio"/> 6 OFF <input type="radio"/> ON <input type="radio"/> 7 OFF <input type="radio"/> ON <input type="radio"/> <small>0=off/1=on (default=0)</small>

Click the ON/OFF radio box to set the power ON/OFF value and then click the button to enable the settings to take effect.

C.3. Safe Value

If the time of the Host PC losing Modbus/TCP communication with the module is greater than the host WatchDog timer setting (called WDT timeout), the output of the Digital and Analog channels is set to the Safe Value, and the count of the host WDT events is increased by one.

AO address 40558 is the address of the Host WDT events. The value of the WDT events will be not stored into EEPROM, and will return to 0 after the module is rebooted. DO address 00515 is the first address of the Safe value and the total number of channels depends on the type of module.

For example:

Address 00515 to 00518 records the Safe value for the 4-Channel ET-7017/PET-7017.

Be careful to set the ON value to DO address 00432 to write the DO Safe value to the EEPROM of the ET-7000/PET-7000 DO module after using Modbus commands (05 or 15) to change the Power ON value.

While the WDT timeout is set, the module can also receive the Modbus/TCP commands (05, 06, 15 and 16) to change the DO or AO value without needing to clear the host watchdog timeout value.

Configuration via Web page

Browse to the homepage of the ET-7000/PET-7000, and click the “Modbus I/O Settings” link in the Configuration Section of the Main Menu tree.

The screenshot shows a web interface for configuring DO Safe Values. On the left, there is a label '515' and a text input field containing 'Safe value for DO'. On the right, there is a vertical list of seven DO channels, each with a radio button for 'OFF' and 'ON', and a refresh icon. The channels are numbered 0 through 7. Below the list, there is a legend: '0=off/1=on (default=0)'. At the bottom center, there is a 'Submit' button.

Click the ON/OFF radio box to set the Safe value and then click the button to enable the settings to take effect.

C.4. AI High/Low Alarm

ET-7017/PET-7017 and ET-7017-10 module equip with the High/Low Alarm function. When the alarm function is enabled, the specified registers are the alarm indicator. The alarm function is to compare the analog input value with given high alarm value and low alarm value.

Address 00636 to 00667 can be used to enable/disable the AI High Alarm function.

Address 00668 to 00699 can be used enable/disable the AI Low Alarm function.

• ET-7017/PET-7017 AI High/Low Alarm Switch Table

Channel Number	AI High Alarm		AI Low Alarm	
	Register	Description	Register	Description
AI0	00636	0: Disable/1: Enable	00668	0: Disable/1: Enable
AI1	00637	0: Disable/1: Enable	00669	0: Disable/1: Enable
AI2	00638	0: Disable/1: Enable	00670	0: Disable/1: Enable
AI3	00639	0: Disable/1: Enable	00671	0: Disable/1: Enable
AI4	00640	0: Disable/1: Enable	00672	0: Disable/1: Enable
AI5	00641	0: Disable/1: Enable	00673	0: Disable/1: Enable
AI6	00642	0: Disable/1: Enable	00674	0: Disable/1: Enable
AI7	00643	0: Disable/1: Enable	00675	0: Disable/1: Enable
AI8	00644	0: Disable/1: Enable	00676	0: Disable/1: Enable
AI9	00645	0: Disable/1: Enable	00677	0: Disable/1: Enable

Address 40296 to 40327 records the High Alarm value. Address 40328 to 40359 records the Low Alarm value. By the default, the High Alarm value is 32767 and the Low Alarm value is -32768.

• **ET-7017/PET-7017 AI High/Low Alarm Value Table**

Channel Number	High Alarm Value of AI		Low Alarm Value of AI	
	Register	Description	Register	Description
AI0	40296	-32768 ~ 32767	40328	-32768 ~ 32767
AI1	40297	-32768 ~ 32767	40329	-32768 ~ 32767
AI2	40298	-32768 ~ 32767	40330	-32768 ~ 32767
AI3	40299	-32768 ~ 32767	40331	-32768 ~ 32767
AI4	40270	-32768 ~ 32767	40332	-32768 ~ 32767
AI5	40271	-32768 ~ 32767	40333	-32768 ~ 32767
AI6	40272	-32768 ~ 32767	40334	-32768 ~ 32767
AI7	40273	-32768 ~ 32767	40335	-32768 ~ 32767
AI8	40274	-32768 ~ 32767	40336	-32768 ~ 32767
AI9	40275	-32768 ~ 32767	40337	-32768 ~ 32767

The analog input High/Low Alarm contains two alarm types, Momentary Alarm and Latch Alarm. Address 00700 of Modbus register can be used to set the High Alarm type of channel 0 and the total number of channels depends on the type of module. Address 00732 of Modbus register can be used to set the Low Alarm type of channel 0.

• **ET-7017/PET-7017 AI High/Low Type Value Table**

Channel Number	AI High Alarm Type		AI Low Alarm Type	
	Register	Description	Register	Description
AI0	00700	0: Momentary Alarm 1: Latch Alarm	00732	0: Momentary Alarm 1: Latch Alarm
AI1	00701	0: Momentary Alarm 1: Latch Alarm	00733	0: Momentary Alarm 1: Latch Alarm
AI2	00702	0: Momentary Alarm 1: Latch Alarm	00734	0: Momentary Alarm 1: Latch Alarm
AI3	00703	0: Momentary Alarm 1: Latch Alarm	00735	0: Momentary Alarm 1: Latch Alarm
AI4	00704	0: Momentary Alarm 1: Latch Alarm	00736	0: Momentary Alarm 1: Latch Alarm
AI5	00705	0: Momentary Alarm 1: Latch Alarm	00737	0: Momentary Alarm 1: Latch Alarm
AI6	00706	0: Momentary Alarm 1: Latch Alarm	00738	0: Momentary Alarm 1: Latch Alarm
AI7	00707	0: Momentary Alarm 1: Latch Alarm	00739	0: Momentary Alarm 1: Latch Alarm
AI8	00708	0: Momentary Alarm 1: Latch Alarm	00740	0: Momentary Alarm 1: Latch Alarm
AI9	00709	0: Momentary Alarm 1: Latch Alarm	00741	0: Momentary Alarm 1: Latch Alarm

The following are the descriptions for two alarm types.

- **Momentary Alarm**

The alarm status is cleared while the analog input is not exceeding the alarm value.

For example:

If analog input value of channel 0 (30001) > High Alarm value (40296), the address 00764 is 1, else it is 0.

If analog input Value of channel 0 (30001) < Low Alarm value (40328), the address 00796 is 1, else it is 0.

The address 00764 to 00795 is the High alarm indicator. If a High alarm occurred, the value of register is 1. In normal condition, it will be 0. The address 00796 to 00827 is the Low alarm indicator. If a Low alarm occurred, the value of register is 1. In normal condition, it will be 0.

- **Latch Alarm**

When the Latch Alarm mode is enabled, the register stays latched until the specified registers are cleared.

For example:

If analog input value of channel 0 (30001) > High Alarm value (40296), the address 00764 is 1, else if analog input value of channel 0 (30001) < Low Alarm value (40328), the address 00796 is 1.

The address 00764 to 00795 is the High alarm indicator. In normal condition, the value of register is 0. If a High alarm occurred, the value of register stays 1 until the address 00764 to 00795 is cleared. The address 00796 to 00827 is the Low alarm indicator. In normal condition, the value of register is 0. If a Low alarm occurred, the value of register stays 1 until the address 00796 to 00827 is cleared.

The address 00764 to 00795 can be used to clear the High Latch Alarm. The address 00796 to 00827 can be used to clear the Low Latch Alarm.

Configuration via Web page

Browse to the homepage of the ET-7000/PET-7000, and click the “Modbus I/O Settings” link in the Configuration Section of the Main Menu tree.

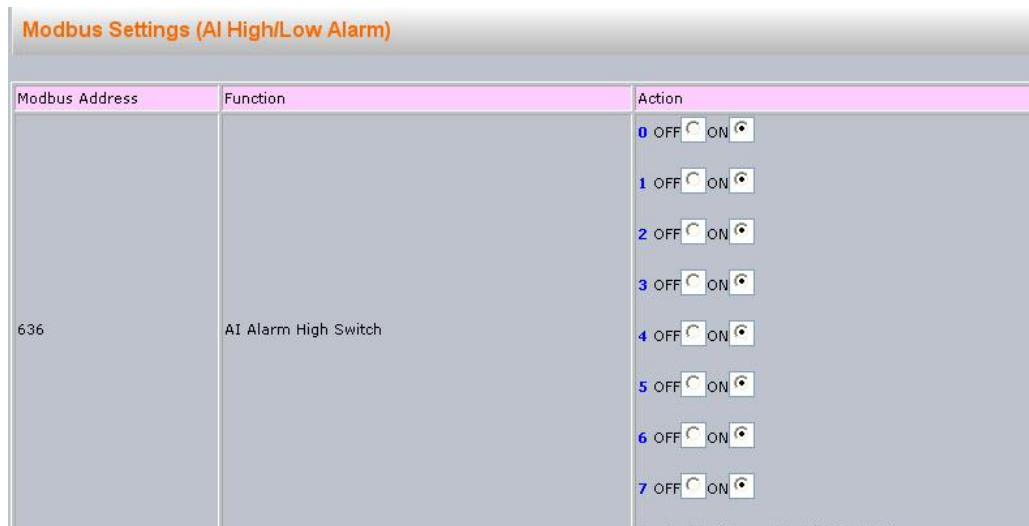

View the Power ON/Safe Value via Web page

Click the “Web HMI” link in the Web HMI Section of the Main Menu tree.

Analog Alarm High/Low Value				
No	High Alarm		Low Alarm	
	Register	Value	Register	Value
AI0	30764	0000	30796	0000
AI1	30765	0000	30797	0000
AI2	30766	0000	30798	0000
AI3	30767	0000	30799	0000
AI4	30768	0000	30800	0000
AI5	30769	0100	30801	0000
AI6	30770	0101	30802	0000
AI7	30771	0001	30803	0000

C.5. AI High/Low Latch

The address 30236 to 30267 records the maximum value of analog inputs and stays the value until another maximum input enters. The address 30268 to 30299 records the minimum value of analog inputs and stays the value until another minimum input enters.

View the Power ON/Safe Value via Web page

Click the “Web HMI” link in the Web HMI Section of the Main Menu tree.

Analog Latched High/Low Value				
No	Latched High		Latched Low	
	Register	Value	Register	Value
AI0	30236	0019	30268	FFD2
AI1	30237	0018	30269	FFED
AI2	30238	0021	30270	FFE5
AI3	30239	0016	30271	FFEC
AI4	30240	002A	30272	FFEC
AI5	30241	0018	30273	FFE0
AI6	30242	0018	30274	FFE9
AI7	30243	0013	30275	FFE9

Moving average value of one AI channel

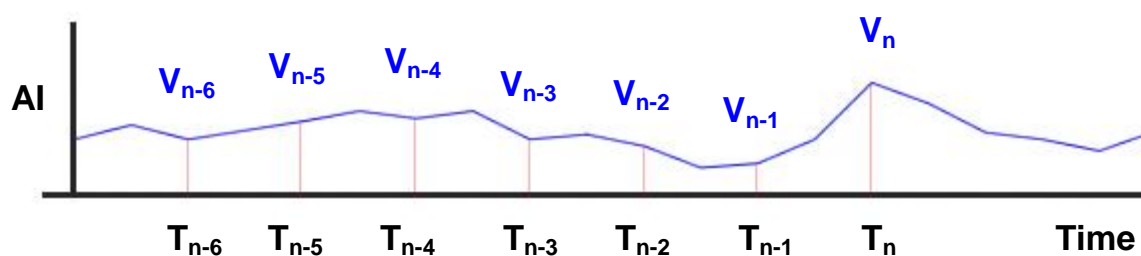

$$V_{Ave_n} = (V_n + V_{n-1} + V_{n-1} + V_{n-3} + \dots + V_{n-6}) / 7 \quad (7: 7 \text{ records})$$

The average value of each AI can be reached on a regular interval when the moving average function is enabled.

For example, a five-item simple moving average would be the sum of the reading value of the five most recent reading value, divided by five; a 20-item moving average would be the sum of the 20 most recent reading value divided by 20, and so on. Each item the most recent reading value is added to the equation and the most distant item is dropped off.

Register	Description
00347	Enable the moving value of the AI channels 0=disabled 1=enabled (Default=0)
40059	Average times for each AI channel 0 ~ 40

Address 30144 to 30153 recodes the average value of each AI channel.

• **ET-7017/PET-7017 Average value of one channel Table**

Channel Number	Register	Description
AI0	30144	0 ~65535 or -32768 ~ +32767
AI1	30145	0 ~65535 or -32768 ~ +32767
AI2	30146	0 ~65535 or -32768 ~ +32767
AI3	30147	0 ~65535 or -32768 ~ +32767
AI4	30148	0 ~65535 or -32768 ~ +32767
AI5	30149	0 ~65535 or -32768 ~ +32767
AI6	30150	0 ~65535 or -32768 ~ +32767
AI7	30151	0 ~65535 or -32768 ~ +32767
AI8	30152	0 ~65535 or -32768 ~ +32767
AI9	30153	0 ~65535 or -32768 ~ +32767

Average value of all AI channel

The value of all AI channel is obtained on a regular interval. The average of AI channels can be reached and then stored in the specified registers.

Register	Description
00348	Enable the average value of all enabled channels, High/Low Alarm value of all AI average value and Average Latched values. 0=disabled 1=enabled (Default=0)
30176	Average value of all enabled AI channel. Address 00595~00626 is used to enable/disable the AI channel. 0 ~ 65535 or -32768 ~ +32767

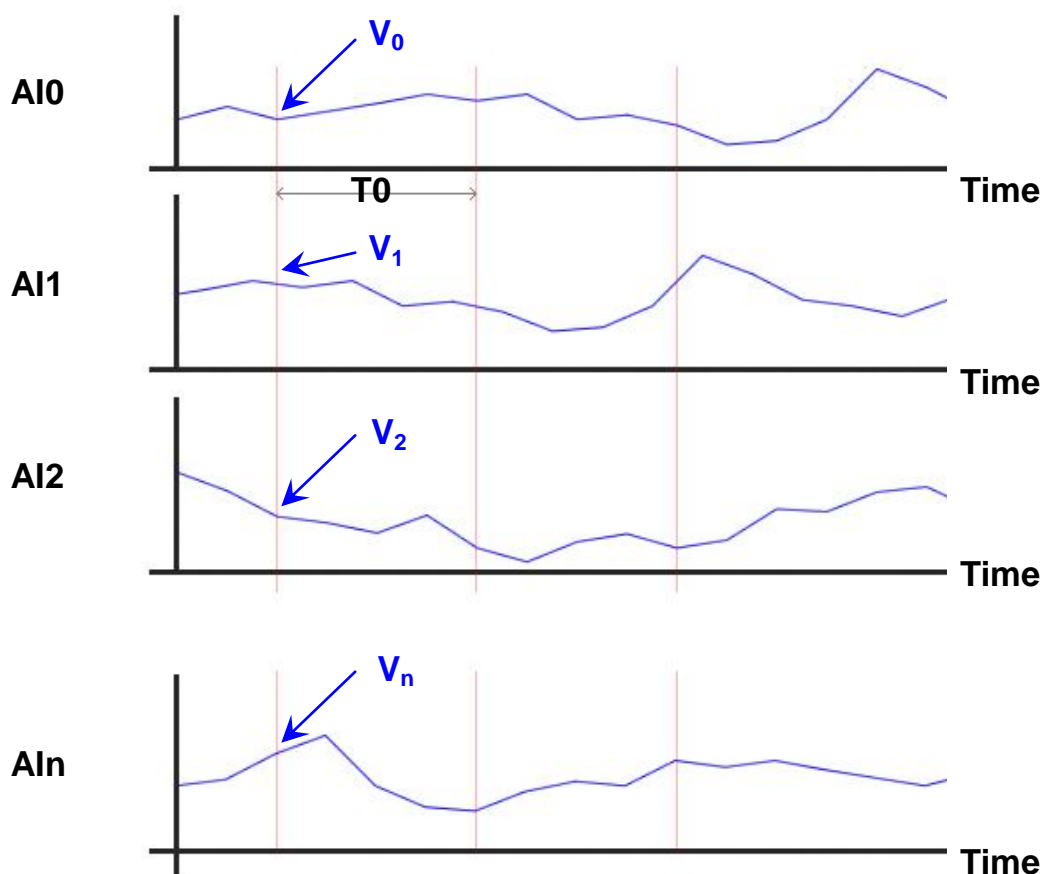

$$V_{Ave_all} = (V_0 + V_1 + V_2 + V_3 + \dots + V_n) / n \quad (n: n \text{ records})$$

High/Low Alarm of the average value of all AI channels

The average value of all AI channels also can equip with the alarm function like the AI High/Low Alarm. For the detailed description, please refer the AI High/Low Alarm.

Register	Description
10336	High alarm for the average value of all AI registers 0=normal 1=alarm
10337	Low alarm for the average value of all AI registers 0=normal 1=alarm
40198	High alarm value for Average value of all AI channels 0 ~ 65535 or -32768 ~ +32767
40199	Low alarm value for Average value of all AI channels 0 ~ 65535 or -32768 ~ +32767

Appendix D. Troubleshooting

A number of common problems are easy to diagnose and fix if you know the cause.

Symptom/Problem	Possible cause	Solution
The Run LED doesn't light	Internal power has failed	Return the module for repair.
The Run LED indicator is ON (light), but not flashing.	The module has possibly crashed.	Reboot the module
Cannot communicate via the Ethernet port, but the PET-7000/ET-7000 is still operating.	The IP/Mask/Gateway address isn't within the IP address range of the LAN.	Change the IP/Mask/Gateway address to match the LAN, or ask the MIS administrator for assistance.
	The IP address has restricted by the IP filter settings	Check the IP filter setting using the Web configuration.
	There are more than 30 TCP/IP connections.	Reboot the module.
Able to explore the web page through port 80 using a web browser, but the Web HMI and Modbus/TCP program cannot access the module through port 502.	Port 502 has been restricted by the firewall.	Consult your MIS administrator for assistance.
The Web HMI and Modbus/TCP program can access the module through port 502, but Web browser cannot explore the web page through port 80 using a web browser.	The Port 502 has restricted by the firewall.	Consult your MIS administrator for assistance.
	The Web Configuration function has been disabled. (Shown on the Basic Settings page)	Enable the Web Configuration function using either the SMMI or the console.
	The Web server TCP port has been changed from port 80 (Shown on the Basic Settings page)	Change the TCP port to 80 or reconnect the PET-7000/ET-7000 using the specific TCP port.